

coronn.com

Finale



## Finale, Italy



### How to find the crags:

At the coast between Nice in France and Genova in Italy you will find Finale Ligure. With 2000 sport climbing routes on more than 20 major crags this area has established a reputation to be one of the best in Europe.

See this road map to get the picture of the structure of the area, see details on each Topos.

First time visitor? [coronn.com](http://coronn.com) recommended crags no. 1, 6,7,teh Boragni part of crag 16 and crag 20.

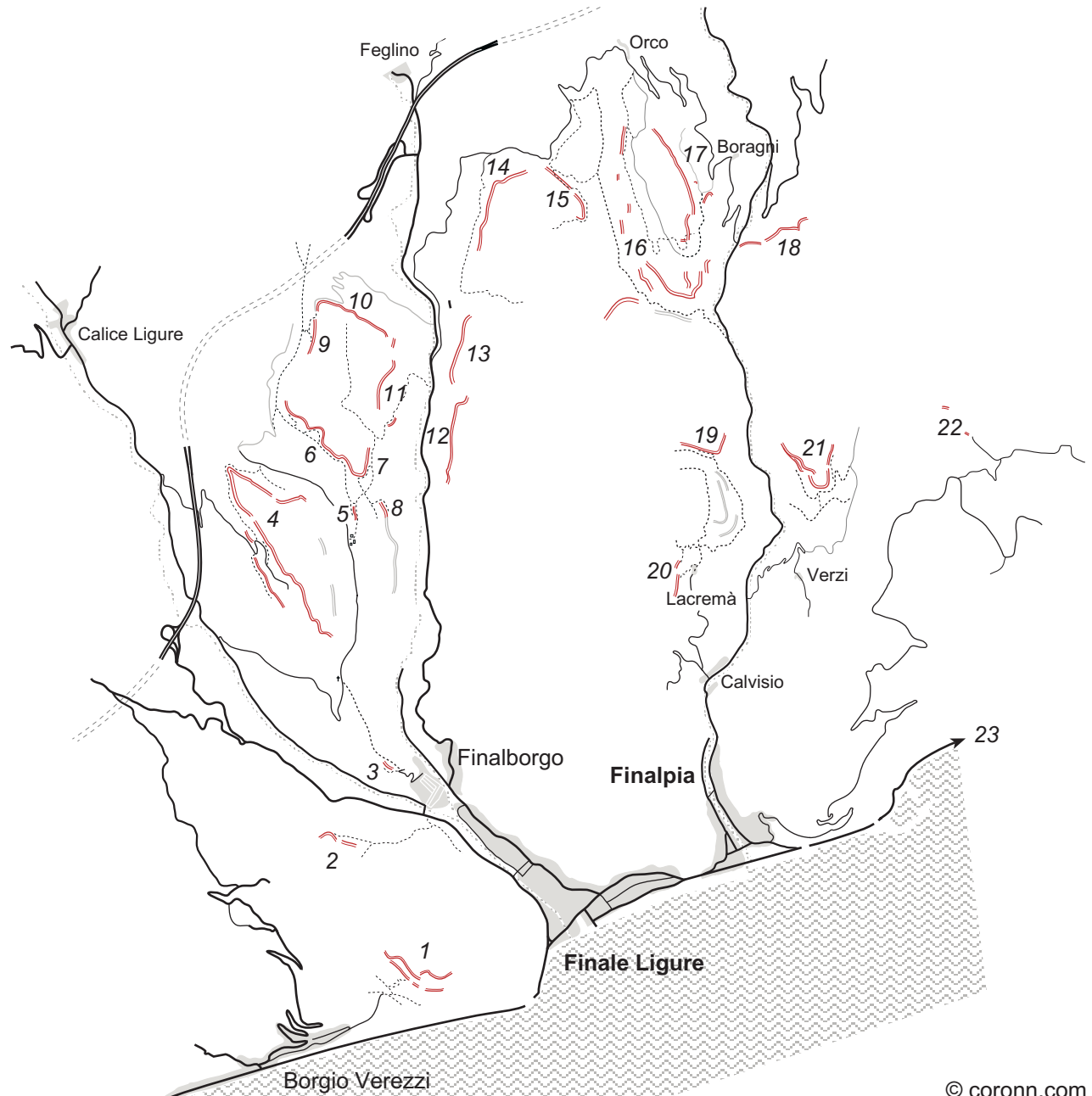

# 1. Caprazoppa, Key-map

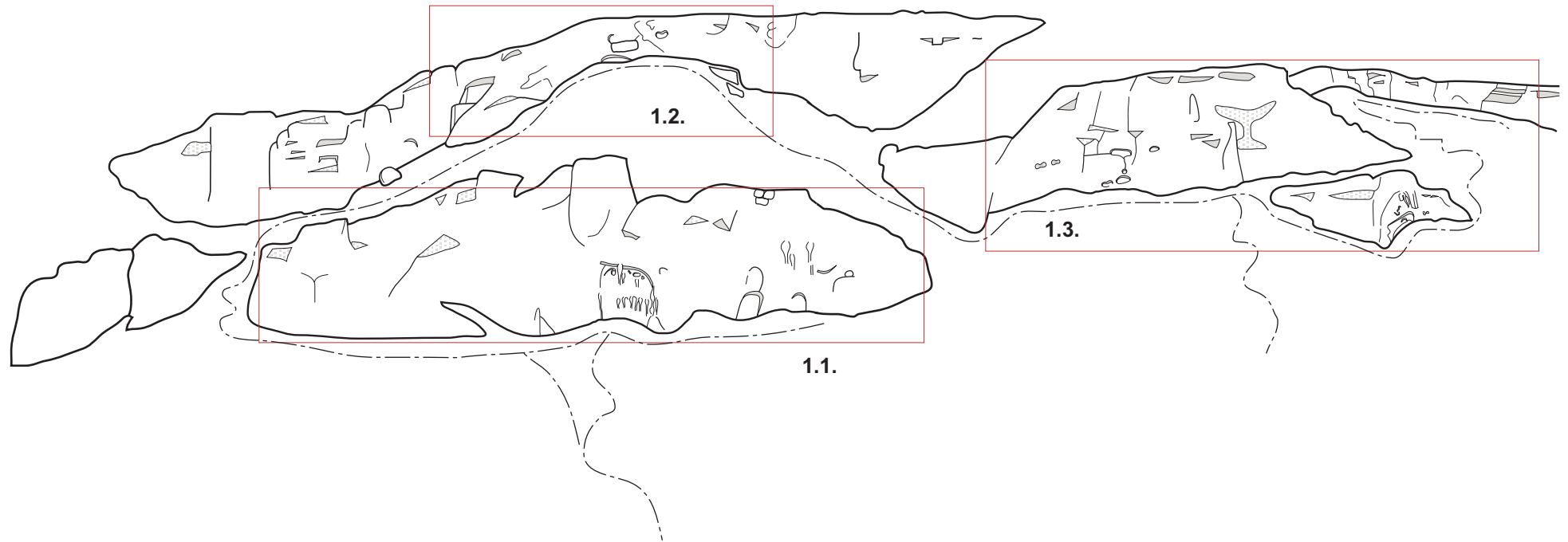

## How to find the crag:

Drive from Finale Ligure in the direction of Pietra Ligure on road S.S.1. Turn left after 2,5 km and follow the signposts for Verezzi. Turn right again on to the first road and continue 200 meters, then turn slightly right on to the small road "Via della Cornice". At the hair point, continue straight forward, pass the big car park and continue on the gravelled road for about 200 meters. Park to the left on a big lay bay. Follow the road and turn left on the track. After about 200 meters, just where two trees stands on each side of the track, turn right on to a small track that leads you to 1.1. "Il Cimitero". Crag no.1. 2. has a long access and not very nice routes, the popular ones is 1.1. and 1.3.

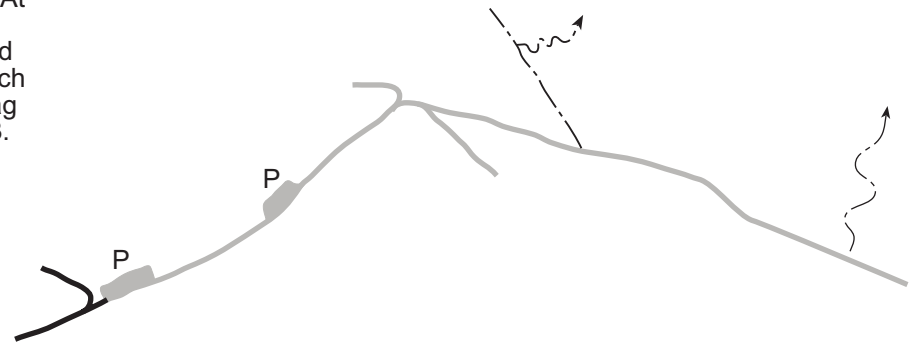

© coronn.com



# 1.1. Caprazoppa, Il Cimitero



N 44° 09.867'  
EO 08° 19.470'

West  
20 m.

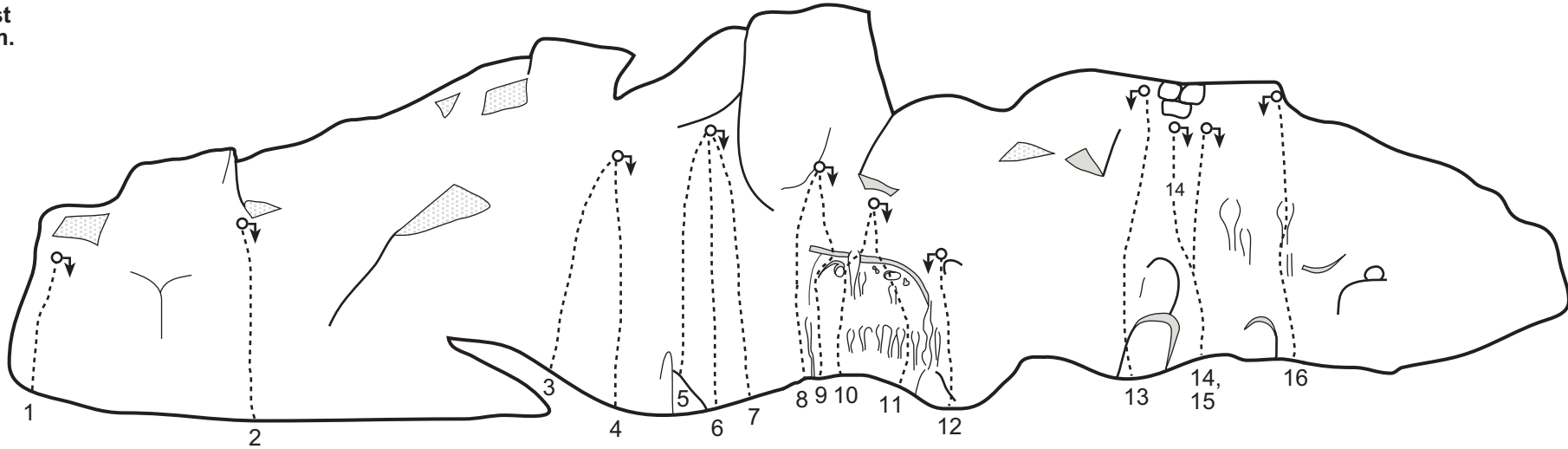

- |                            |     |                                    |     |
|----------------------------|-----|------------------------------------|-----|
| 1. Vaticano                | 6c  | 10. Flauto di vertebre             | 7a+ |
| 2. Tostau                  | 5c  | 11. Sacco d'ossa                   | 7b+ |
| 3. Un metro sotto          | 6b  | 12. Seppia grassa                  | 6a+ |
| 4. Tomba la Bomba          | 6c  | 13. Considerazioni di un distratto | 6c  |
| 5. Clic si gira            | 6a+ | 14. The return of Jedi             | 6b  |
| 6. Psicologica             | 6a  | 15. The dark side of the force     | 6b  |
| 7. Ultima alba             | 6c+ | 16. The Empire strikes back        | 6a+ |
| 8. Easy to remember        | 7a  |                                    |     |
| 9. Another day in Paradise | 6c+ |                                    |     |

© coronn.com

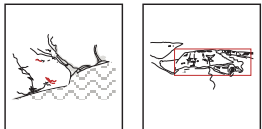

## 1.2. Caprazoppa, L'Orizzonte



West  
13 m.

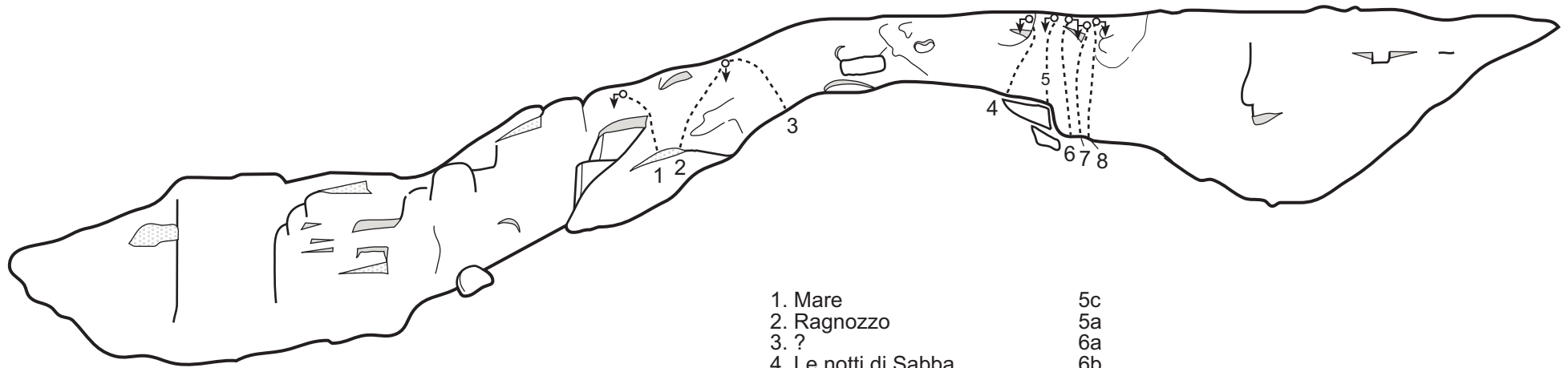

- |                        |    |
|------------------------|----|
| 1. Mare                | 5c |
| 2. Ragnozzo            | 5a |
| 3. ?                   | 6a |
| 4. Le notti di Sabba   | 6b |
| 5. Cippi lippa         | 5a |
| 6. Orizzonte           | 6c |
| 7. La casa del Peccato | 6a |
| 8. ?                   | 6a |

© coronn.com

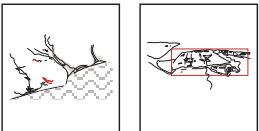

### 1.3. Caprazoppa, Parsifal, Canazei and Pietra del Sole



West  
15 m.

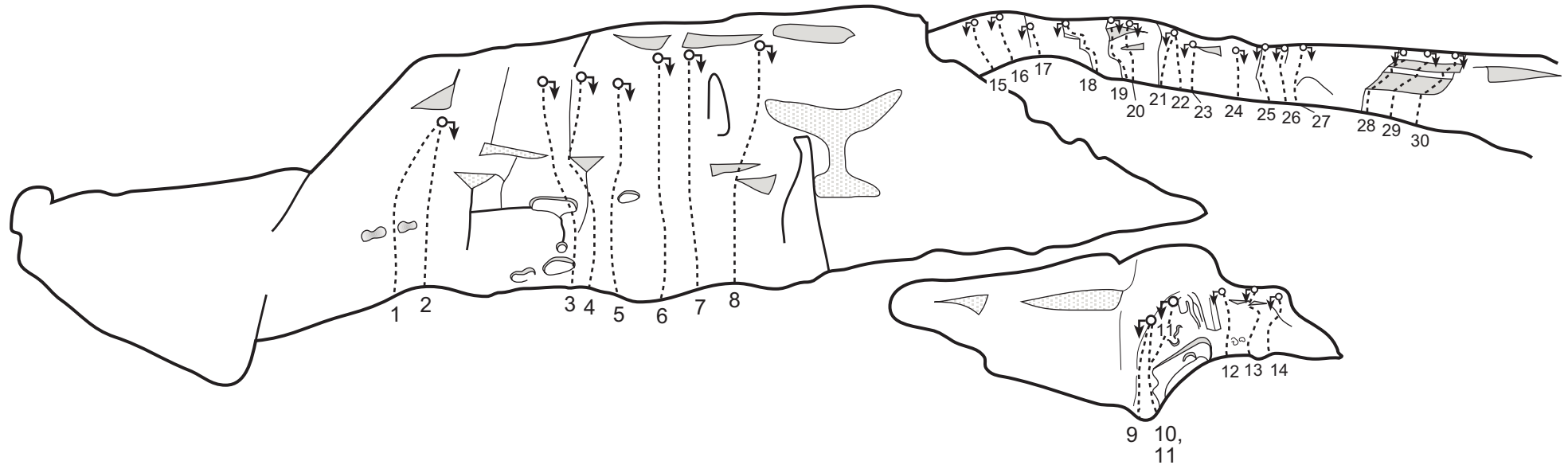

- |                                 |     |                                 |     |
|---------------------------------|-----|---------------------------------|-----|
| 1. One step up                  | 6b  | 15. Azzo la marina              | 5c  |
| 2. Presagio                     | 6c  | 16. MM (unstable blocks!!)      | 6a  |
| 3. Dom Perignon                 | 6b+ | 17. Sera ceno                   | 5c  |
| 4. Parsifal                     | 6a  | 18. Gioca astuto                | 6a  |
| 5. Amici della Erotica          | 6a+ | 19. Bel air                     | 6a+ |
| 6. Il mercante di appigli       | 6a+ | 20. Roberta lo spit dei 20 Anni | 6a  |
| 7. Viola per poco               | 6a  | 21. La Chiave                   | 6a+ |
| 8. L'Oracolo Tibetano           | 5c  | 22. Luna Piena                  | 5a  |
| 9. La dolce fessura             | 6b  | 23. Il Mozzo                    | 4a  |
| 10. Ti Abbandoni liberi le mani | 6b  | 24. Azimut                      | 4c  |
| 11. Buon                        | 6c  | 25. I Piramidali di Cheope      | 5c  |
| 12. Sentiero di Pietra          | 6c  | 26. Passagel                    | 5a  |
| 13. Utopia di un gesto          | ?   | 27. Dalai Lama                  | 5b  |
| 14. Orizzonti verticali         | 6c+ | 28. Pose inesplose              | 6b  |
|                                 |     | 29. Polvere di sogno            | 7a+ |
|                                 |     | 30. Tillerman                   | 7a+ |

© coronn.com

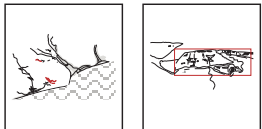

## 2. Rocce dell' Orera

East  
90 m.

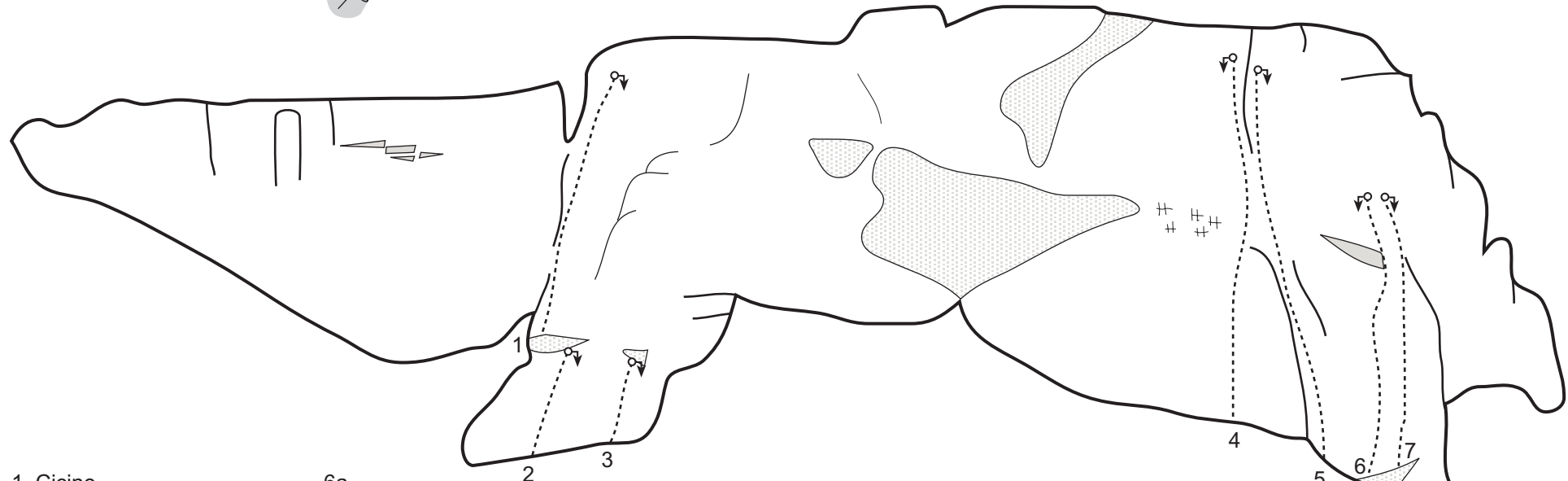
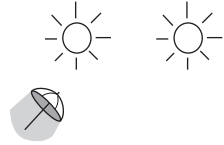

- 1. Cicino
- 2. ?
- 3. ?
- 4. Via degli urlatori
- 5. I diedri obliqui
- 6. ?
- 7. Maddalena
- 8. Stringile piano
- 9. Stringile forte

- 6a
- 6a
- 5c
- 6a
- 5a
- ?
- 5c
- 5a
- 6b

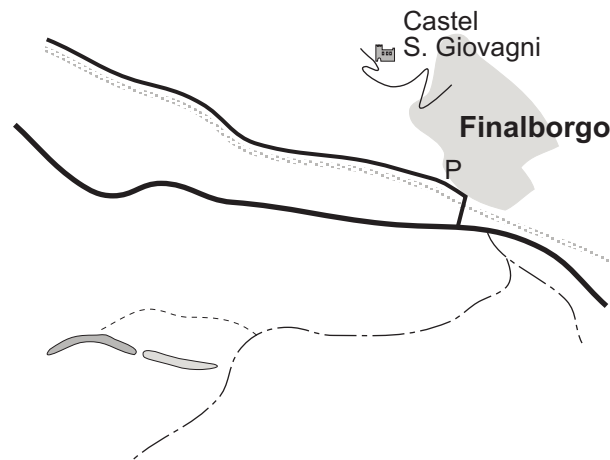

### How to find the crag:

Drive from Finale Ligure in the direction of Finalborgo and the entrance to the highroad. Turn left in the direction of Finalborgo, then turn left after the bridge (and before entering Finalborgo) and park at a public car park outside the Finalborgo (city-wall). Walk back over the bridge, turn left and after 150 meters, cross the road on to a "dirt road" and follow the track with tree red points mark. After about 15 minutes, turn right on to a small track that leads to the crag. Long approach, not the best climbing and compared with other crags, not worth fighting for.

© coronn.com

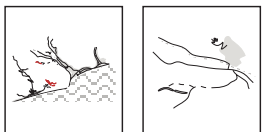

### 3. Paretina di Finalborgo

N 44° 10.637'  
EO 08° 19.420'

West  
20 m.

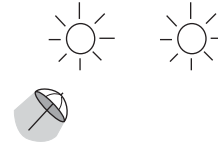

- |                             |     |
|-----------------------------|-----|
| 1. Medcamalia               | 6b  |
| 2. Sgrillettami             | 6a+ |
| 3. Il Labirinto             | 6a  |
| 4. ?                        | ?   |
| 5. ?                        | 5+  |
| 6. Cessule' stu Casinu      | 6a  |
| 7. Tira dritto furbacchione | 6b  |

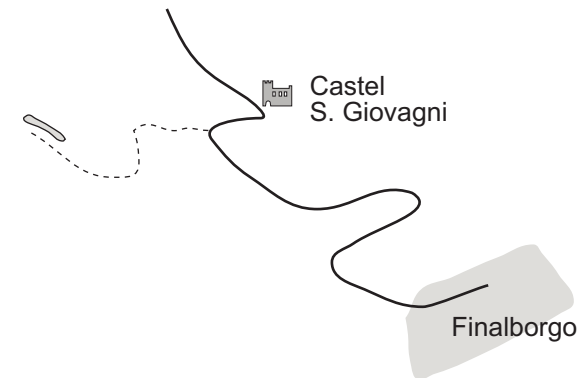
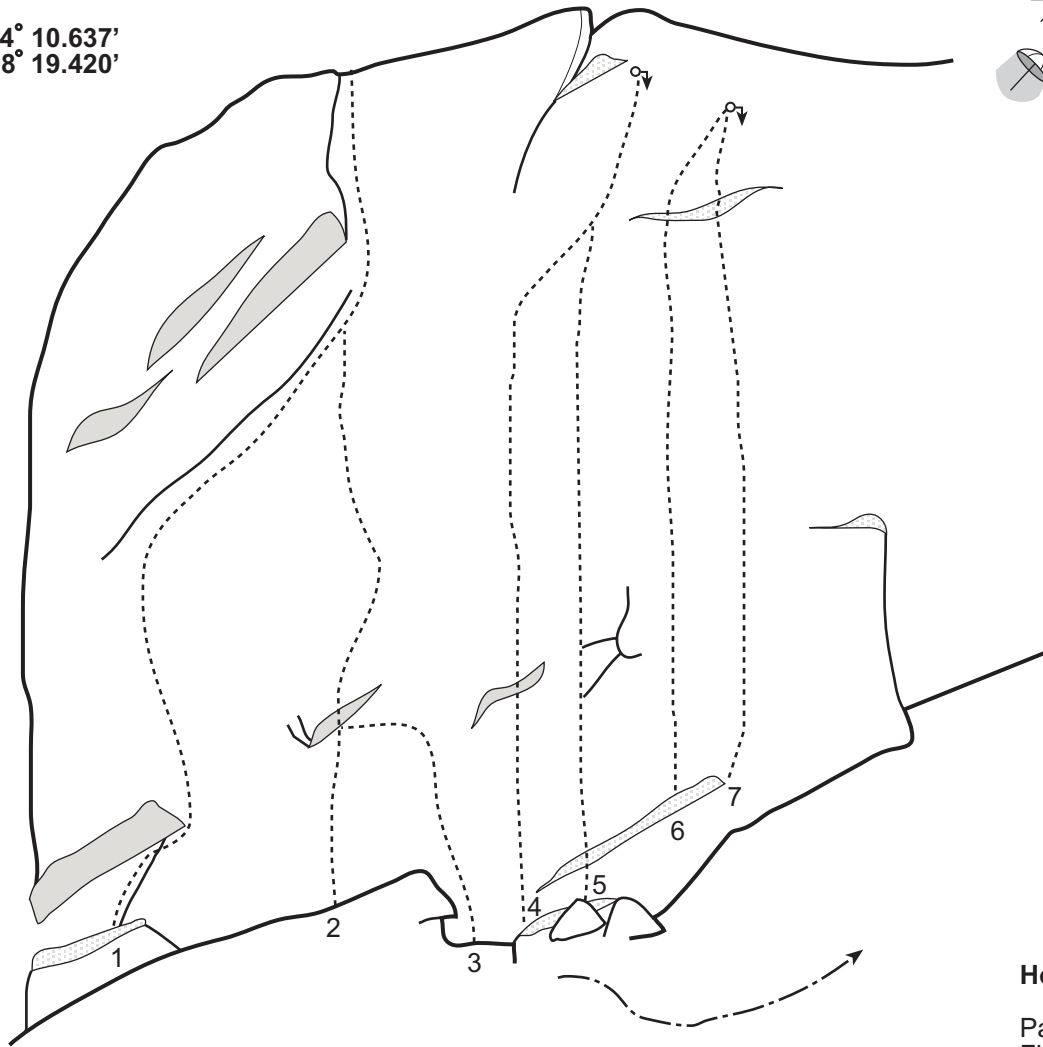

© coronn.com

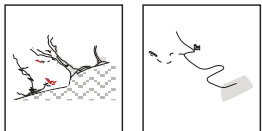

#### How to find the crag:

Park at any of the public car park outside the old part of Finalborgo. Enter the city and walk in the direction of the old Castle that you will see on a hill above the city. Just before you reach the Castle, in a hair pint, turn left on a small track that leads to this track. The crag is located above an Industrial estate, not beautiful, no nice climbing.



## 4.0. Rocca di Perti, Key-map for the South-West part

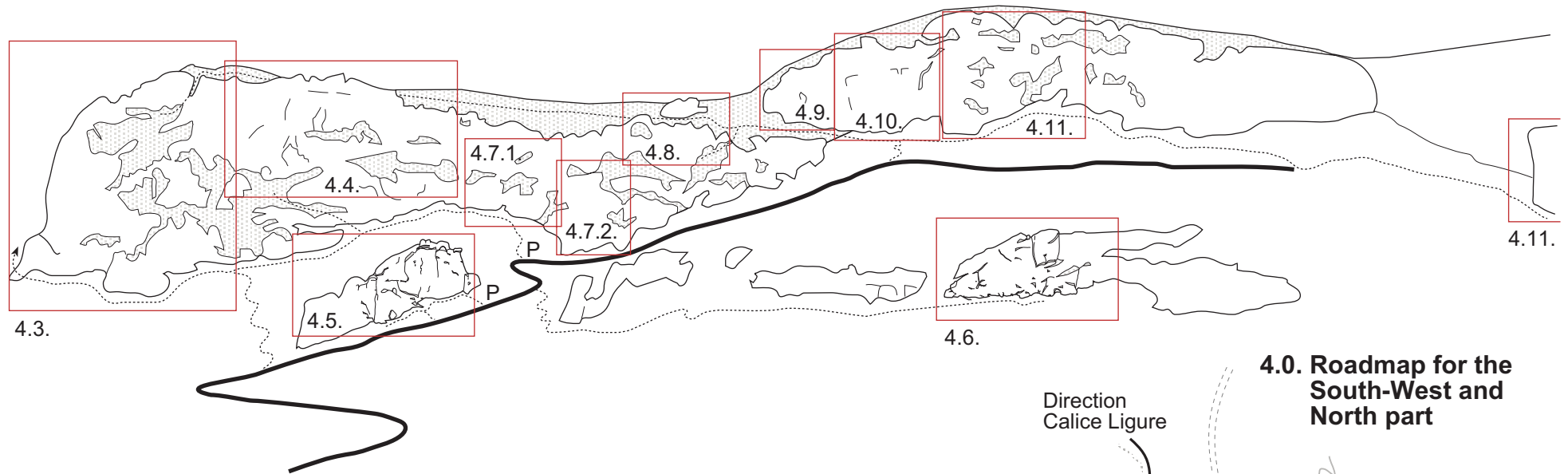

### How to find the crag:

Drive from Finale Ligure in the direction of the highroad. Turn right in the direction of Finalborgo and turn left before the city wall in the direction of Calice Ligure. To reach 4.1. and 4.2. Turn right in the direction of the Castle "Gavone", continue until the road ends in a car park with two small gravelled road that turns right. Follow the track to the crags (Il Grotto is a little bit tricky to get to, however, you will see it from the car park and would find it). For the rest of Rocca di Perti, drive in the direction of Calice Ligure, pass under the highroad and turn right on a small road signed "Rocca di Perti". Continue and park on a lay bay just beside the crag 4.4.

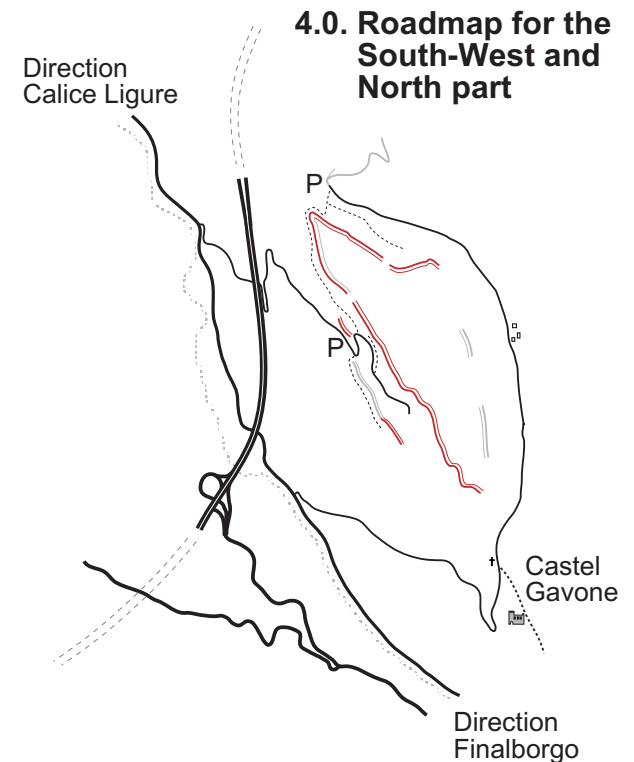

© coronn.com

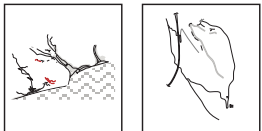

# 4.1. Rocca di Perti, Il Grotto

N 44° 11.647'  
EO 08° 18.844'

North  
30 m.

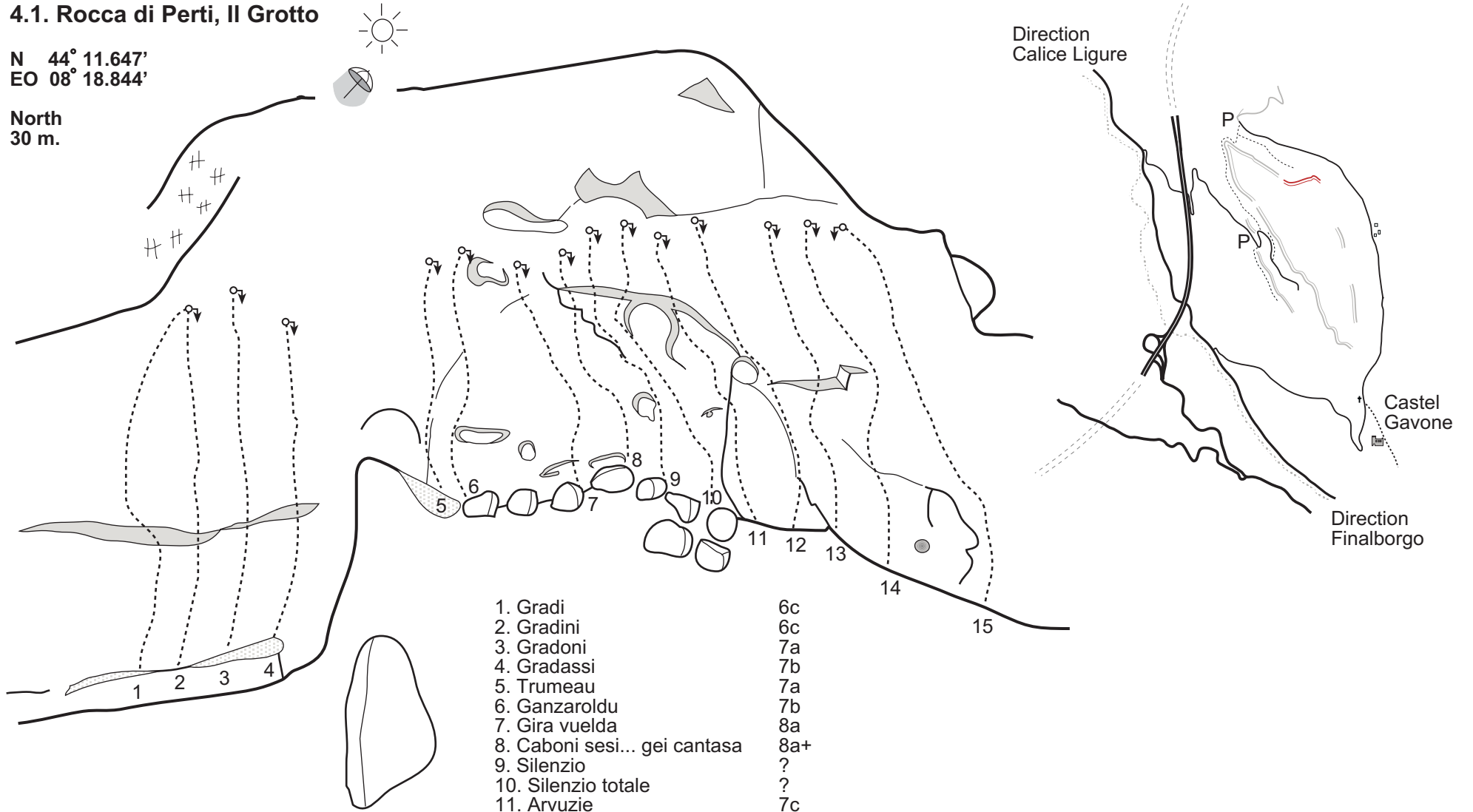

- |                               |     |
|-------------------------------|-----|
| 1. Gradi                      | 6c  |
| 2. Gradini                    | 6c  |
| 3. Gradoni                    | 7a  |
| 4. Gradassi                   | 7b  |
| 5. Trumeau                    | 7a  |
| 6. Ganzaroldu                 | 7b  |
| 7. Gira vuelta                | 8a  |
| 8. Caboni sesi... gei cantasa | 8a+ |
| 9. Silenzio                   | ?   |
| 10. Silenzio totale           | ?   |
| 11. Arvuzie                   | 7c  |
| 12. Rustegu                   | 7c+ |
| 13. Commodino                 | 7b  |
| 14. Murzega                   | 7c  |
| 15. Sedia                     | 6c  |

© coronn.com

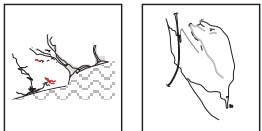

## 4.2. Rocca di Perti, Versante Nord

North  
25 m. Multi pitch up to 120 m.

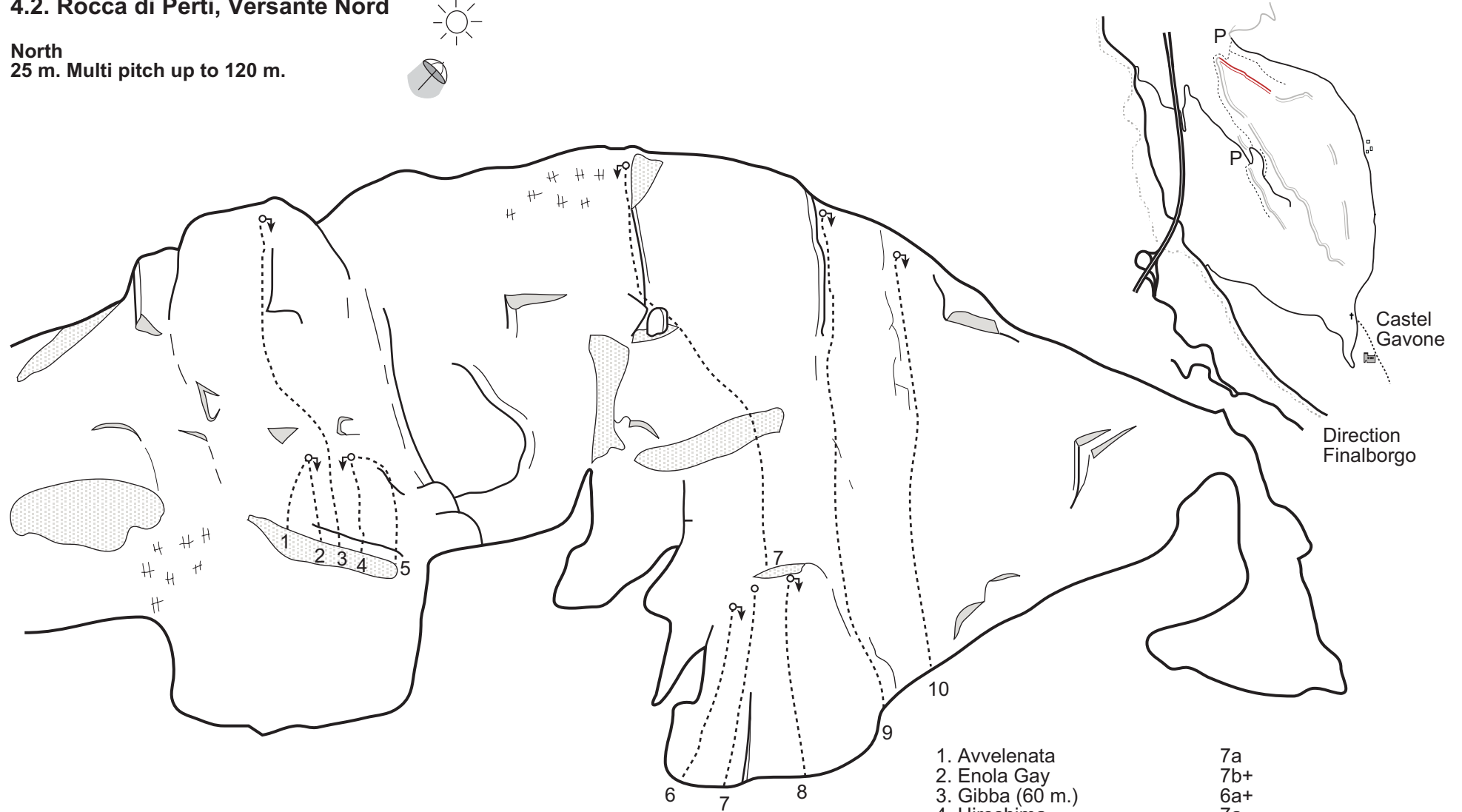
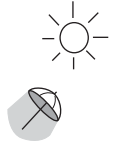

- |                            |     |
|----------------------------|-----|
| 1. Avvelenata              | 7a  |
| 2. Enola Gay               | 7b+ |
| 3. Gibba (60 m.)           | 6a+ |
| 4. Hiroshima               | 7a  |
| 5. Variante                | ?   |
| 6. Mas de Nada             | 6b+ |
| 7. Via col vento (120 m.)  | 4c  |
| 8. ?                       | 5c  |
| 9. Purchin (90 m.)         | 5b  |
| 10. Bruja baracche (90 m.) | 6a  |

© coronn.com

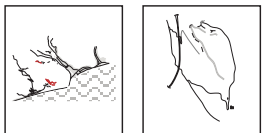

### 4.3. Rocca di Perti, Settore Settentrionale and Il Giardino

South-West  
40 m. Multi pitch up to 150 m.

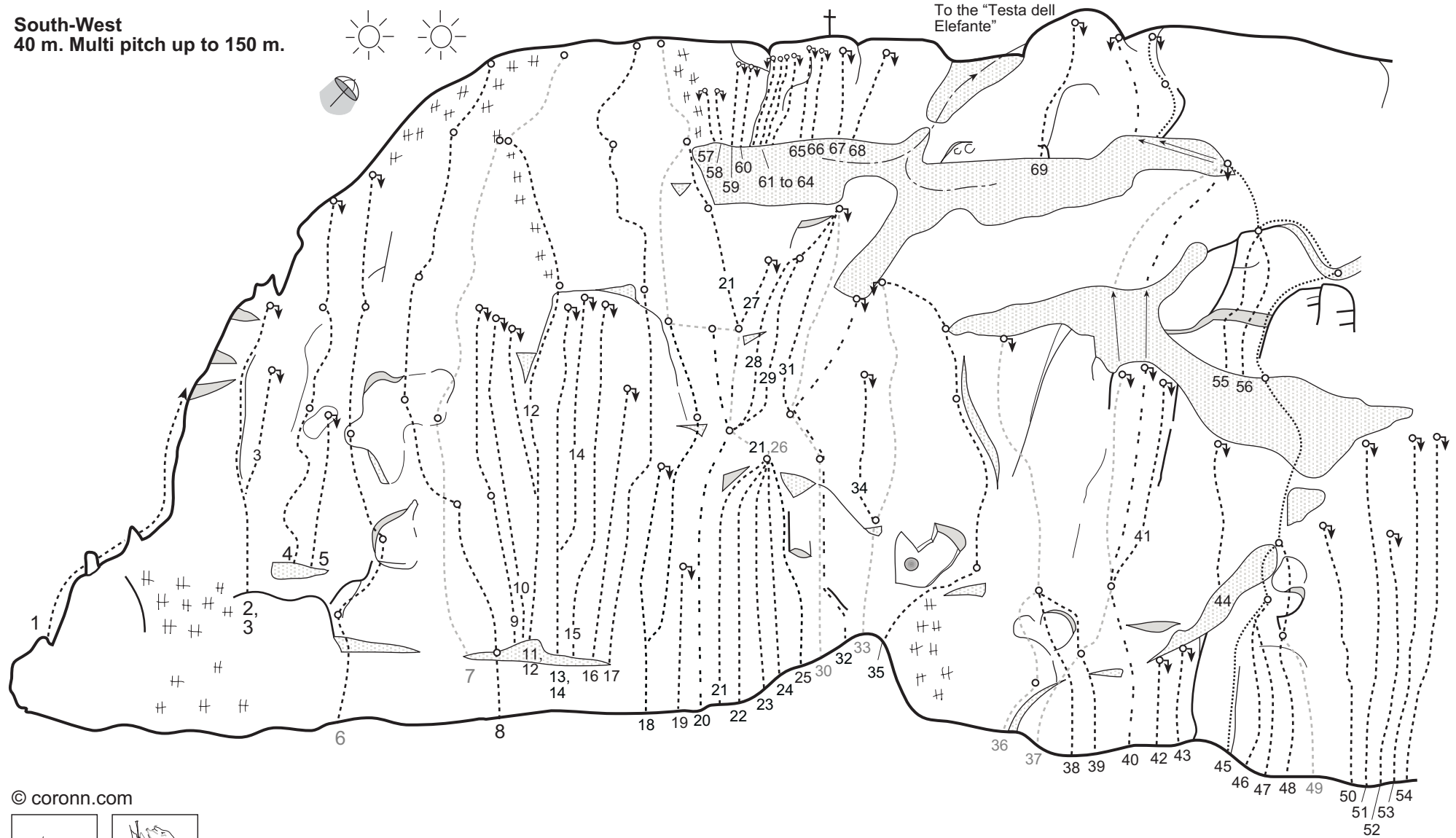

© coronn.com

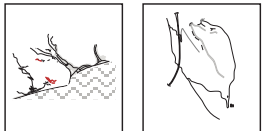

### 4.3. Rocca di Perti, Settore Settentrionale and Il Giardino

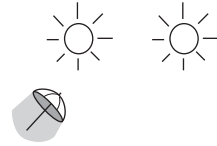

South-West

40 m. Multi pitch up to 150 m.

1. Lo Spigolo (150 m.)	3b	30. Forza d'Androide (70 m.)	5a,6a,6b
2. Smaram (60 m.)	4c,5c	31. ?	?
3. Popotami e lebellule	4c,5c	32. Nicora (70 m.)	3c,5c
4. L'incredibile Hulk (100 m.)	4c,6b,6c	33. L'ultimo Ringo (60 m.)	5b,5c,6a
5. Cure your jets	7a+	34. Saggio Yoda	5c
6. Mariangela (120 m.)	5a,4c,5b,4c	35. Diedro obliquo (70 m.)	5c
7. Fria	6b+,7a+	36. Carmen Russo (80 m.)	5c,5,6b
8. Flavia (140 m.)	5b,5a,5b,6b+,5a,4c	37. Antica Osteria (80 m.)	5c
9. Scrapizza (60 m.)	7a,6c	38. Ambigua	6c
10. E.T.	6c	39. C.T.	5c,5c
11. Quae de munta'	6b	40. Elena (110 m.)	6b+,6b,5c,6b
12. Diedro mesciulam (60 m.)	5c,4c	41. Neurone Rosso	6a+
13. Finale furioso	7a,6c	42. La Gruviera	6b+
14. Attimo fuggente	7a+	43. Il ritorno di Jacko	5c
15. Spit surf (60 m.)	6b,7a+	44. Fuga da Alcatraz	6c
16. Innuendo	7b	45. Simonetta (150 m.)	3b,1,4b,4b,4b,4b
17. L'altra faccia della Luna (120 m.)	6b,5+,5+,6a	46. Angela	6a
18. Chiodidi garofano (60 m.)	5c,5c	47. Antonella	6a
19. Opus III	6a+	48. Variant of Simonetta	5b,6b
20. Gold Finger (70 m.)	6a,6c	49. Il Peppo	5b
21. Nadia (100 m.)	5,4c,6b,5a,4c	50. Classica	6a
22. Variante L1 of Nadia	6a+	51. Optymistique	6b
23. Provaci un pó	5c	52. Cambio casa	7a+
24. Coccolino	6a+	53. Capo/danno	6b
25. ?	?	54. ...io credo...	6b+
26. Il vecchio (150 m.)	6a,4b,5c,5a,4c	55. Zip	6c
27. Quattro passi nel fantastico	5c	56. Jodio 131	6b
28. Il Desiderio	6a+	57. Incapace	6a
29. La coda del Drago	6b+	58. Libera la vita	6c
		59. ...poi capace	8a
		60. All' incomincio	8a
		61. Memo	6a+
		62. Spunti di vista	6b+
		63. Via senza appigli	?
		64. Bimbo a bordo	7a+
		65. Mr. Steel	8a
		66. Mariotta	7a
		67. La classe operaia va in paradiso	6a
		68. Proletario straordinario	6b+
		69. Dacci	8a+

© coronn.com

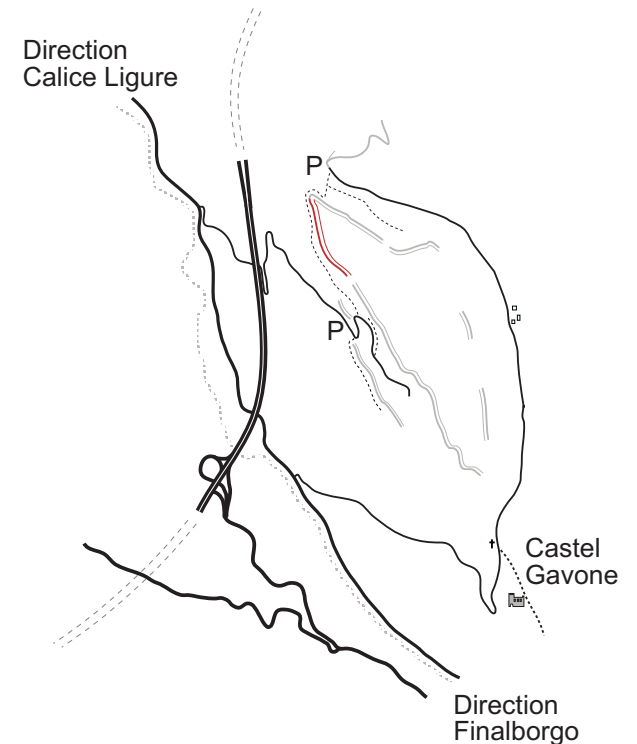
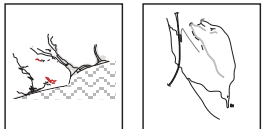

#### 4.4. Rocca di Perti, Settore Centrale and L'Olimpo

South-West

40 m. Multi pitch up to 80 m.

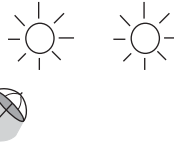

#### Settore L'Olimpo

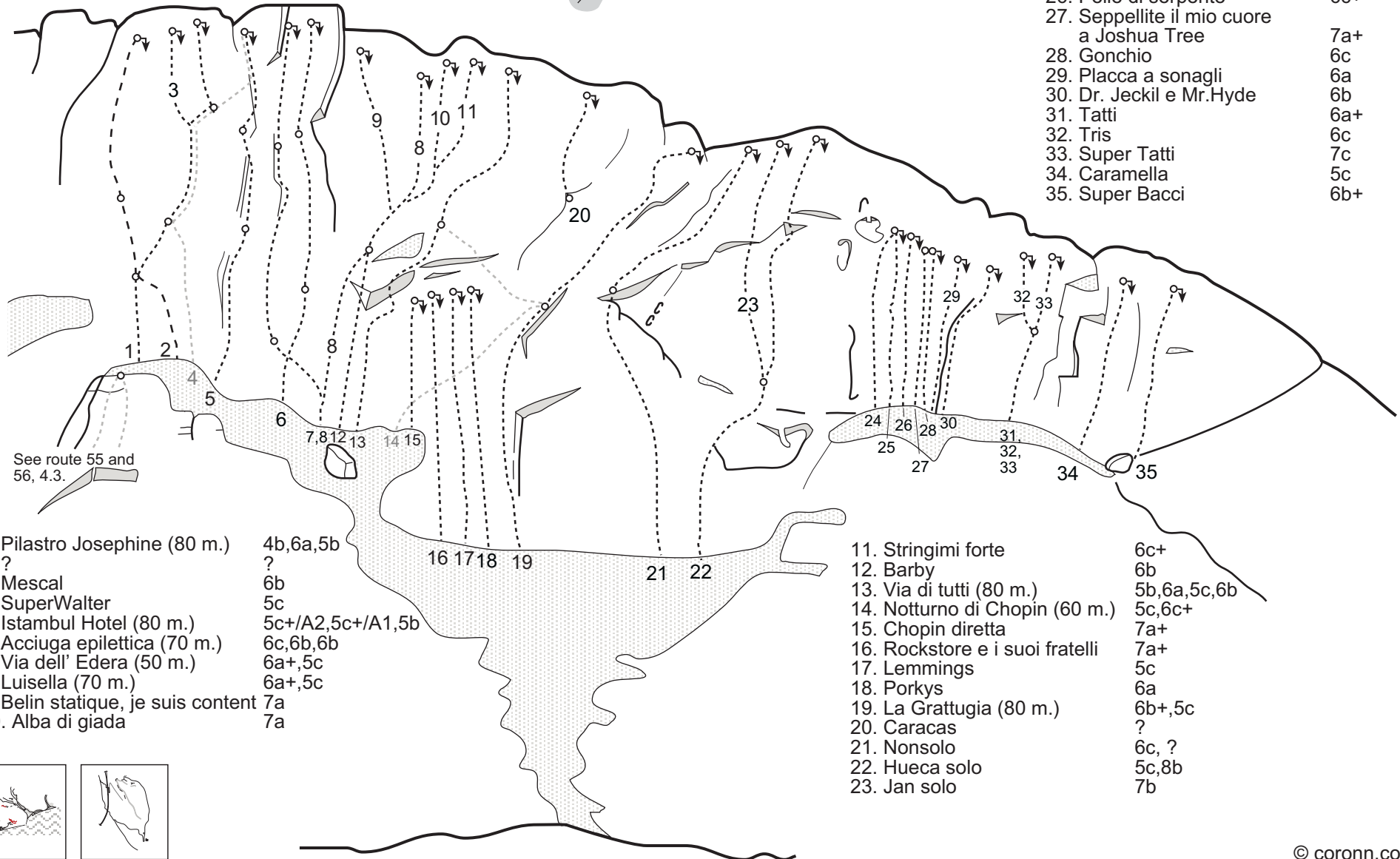

See route 55 and 56, 4.3.

- 1. Pilastro Josephine (80 m.) 4b,6a,5b
- 2. ? ?
- 3. Mescal 6b
- 4. SuperWalter 5c
- 5. Istanbul Hotel (80 m.) 5c+/A2,5c+/A1,5b
- 6. Acciuga epilettica (70 m.) 6c,6b,6b
- 7. Via dell' Edera (50 m.) 6a+,5c
- 8. Luisella (70 m.) 6a+,5c
- 9. Belin statique, je suis content 7a
- 10. Alba di giada 7a

- 11. Stringimi forte 6c+
- 12. Barby 6b
- 13. Via di tutti (80 m.) 5b,6a,5c,6b
- 14. Notturmo di Chopin (60 m.) 5c,6c+
- 15. Chopin diretta 7a+
- 16. Rockstore e i suoi fratelli 7a+
- 17. Lemmings 5c
- 18. Porkys 6a
- 19. La Grattugia (80 m.) 6b+,5c
- 20. Caracas ?
- 21. Nonsolo 6c, ?
- 22. Hueca solo 5c,8b
- 23. Jan solo 7b

- 24. Antiche storie 6b+
- 25. Cuore selvaggio 6b
- 26. Pelle di serpente 6c+
- 27. Seppellite il mio cuore a Joshua Tree 7a+
- 28. Gonchio 6c
- 29. Placca a sonagli 6a
- 30. Dr. Jeckil e Mr.Hyde 6b
- 31. Tatti 6a+
- 32. Tris 6c
- 33. Super Tatti 7c
- 34. Caramella 5c
- 35. Super Bacci 6b+

# 4.5. Rocca di Perti, Parete delle Gemme

N 44° 11.497'  
EO 08° 18.659'

South-West  
35 m.

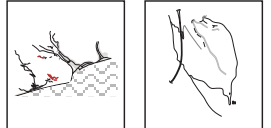
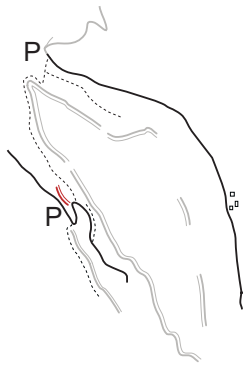
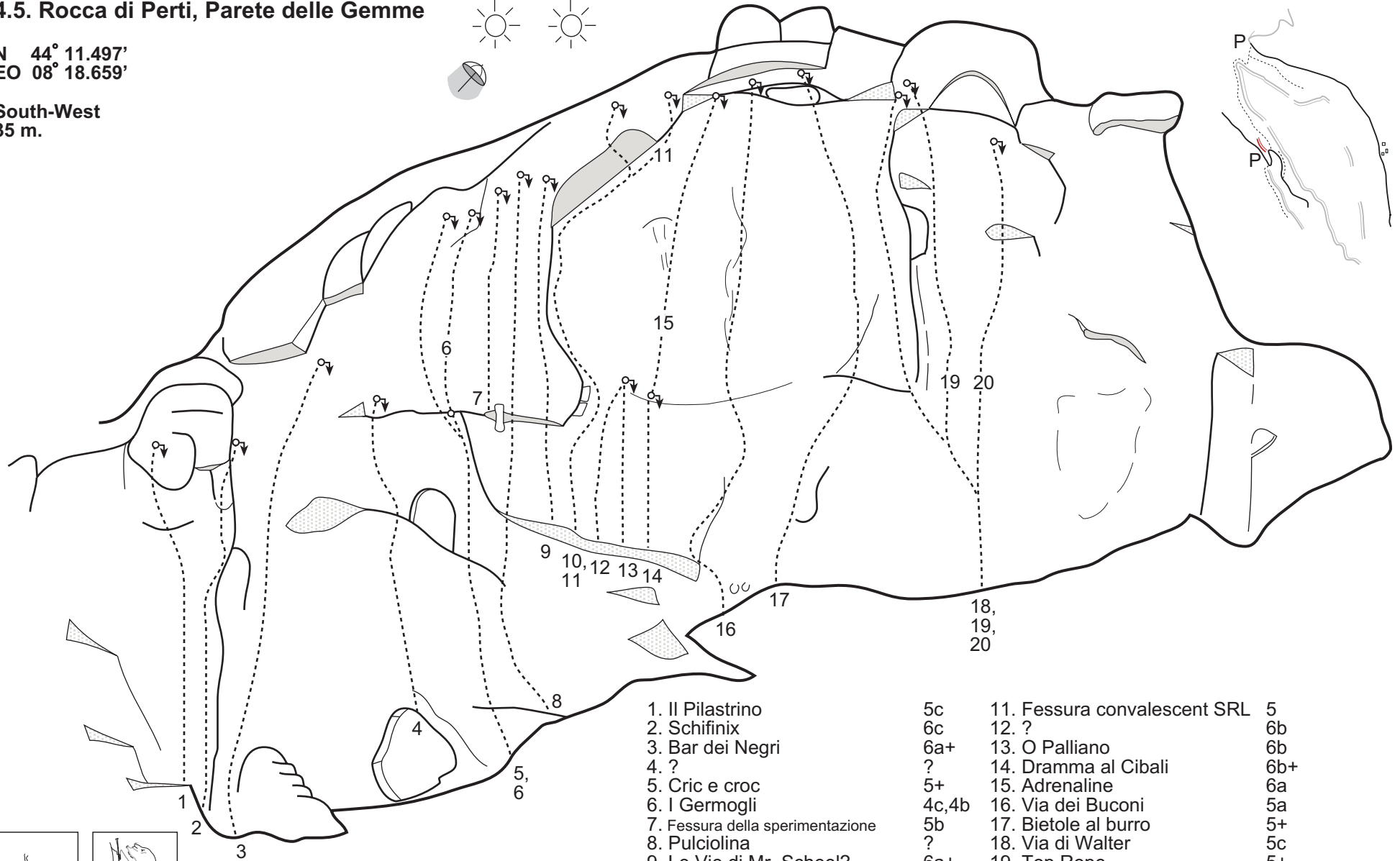
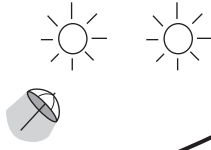

- |                                  |       |                              |     |
|----------------------------------|-------|------------------------------|-----|
| 1. Il Pilastrino                 | 5c    | 11. Fessura convalescent SRL | 5   |
| 2. Schifnix                      | 6c    | 12. ?                        | 6b  |
| 3. Bar dei Negri                 | 6a+   | 13. O Palliano               | 6b  |
| 4. ?                             | ?     | 14. Drama al Cibali          | 6b+ |
| 5. Cric e croc                   | 5+    | 15. Adrenaline               | 6a  |
| 6. I Germogli                    | 4c,4b | 16. Via dei Buconi           | 5a  |
| 7. Fessura della sperimentazione | 5b    | 17. Bietole al burro         | 5+  |
| 8. Pulciolina                    | ?     | 18. Via di Walter            | 5c  |
| 9. Le Vie di Mr. Scheel?         | 6a+   | 19. Top Rope                 | 5+  |
| 10. Tetto del Kaiser             | 6c    | 20. Flebo                    | 6a  |

## 4.6. Rocca di Perti, Placca dell' Oasi

N 44° 11.335'  
EO 08° 18.759'

South-West  
30 m.

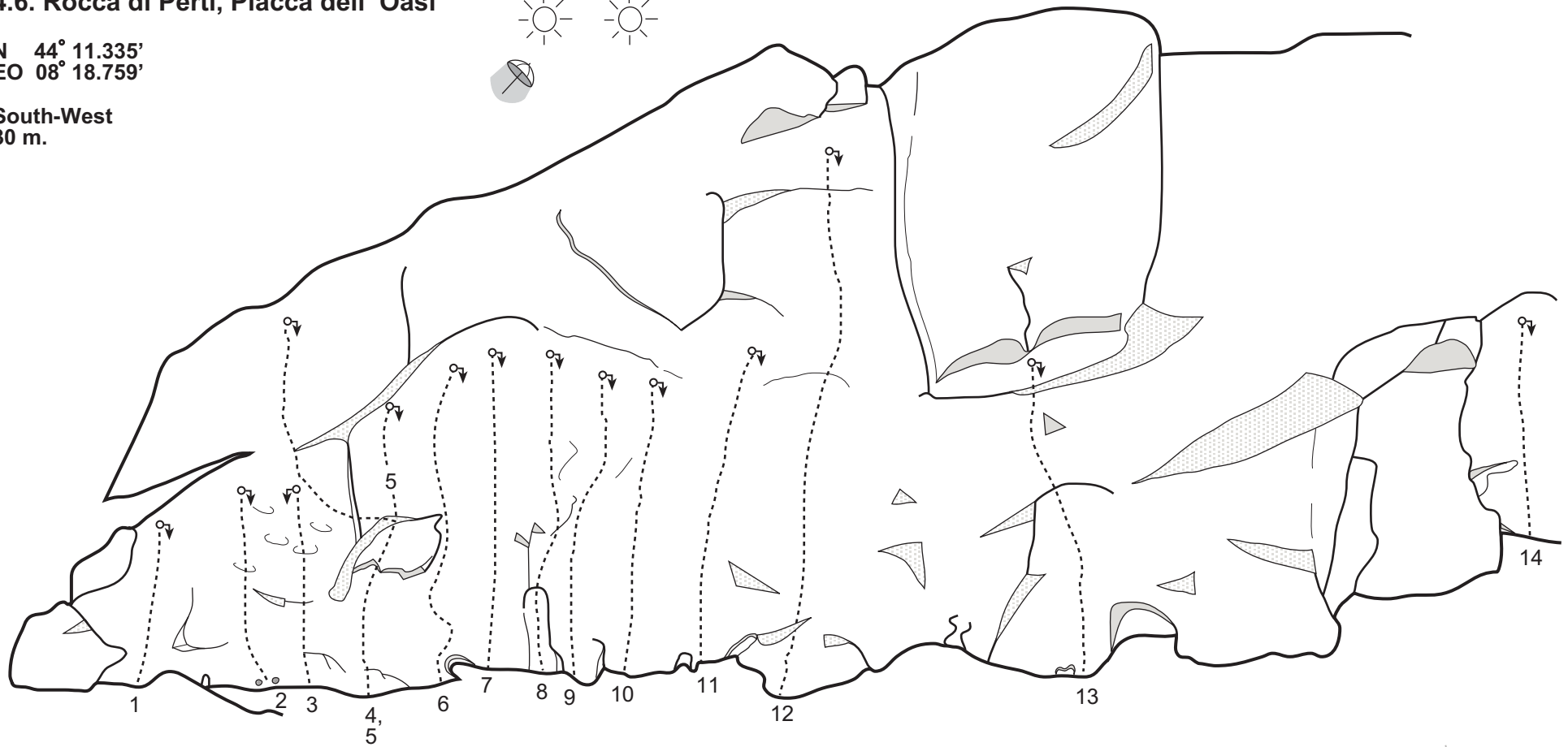
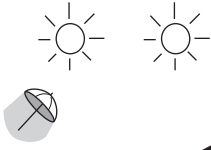

- 1. Cris Cris
- 2. Scroc
- 3. Sly
- 4. Have a good day
- 5. Nosce Te Ipsum
- 6. Balance
- 7. Calami pure

- 6a
- 6a
- 6b
- 6a+
- 6b
- 6a+
- 6a+
- 7a
- 8. Octopus
- 9. My friend Paul
- 10. Grigio perla
- 11. Serena
- 12. ?
- 13. Coure di panna
- 14. Pi. Na

- 6c+
- 6b+
- 6a+
- 4
- 5c
- 5b
- 5c

© coronn.com

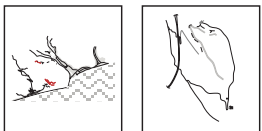

### How to find the crag:

Park on a lay bay just beside crag 4.4. Continue on the road and in the first hairpin bend, turn right and follow the track to this crag.

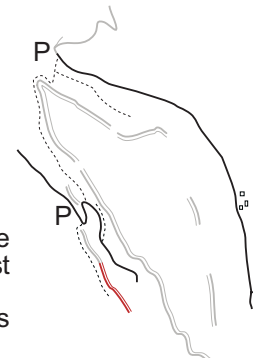



### 4.7.1. Rocca di Perti, Ombre Blu

South-West  
30 m. Multi Pitch up to 90 m.

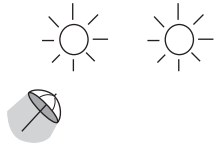

- |                            |           |                                   |            |
|----------------------------|-----------|-----------------------------------|------------|
| 1. Bianche mani            | 7b+       | 11. Finalmente                    | 6a+        |
| 2. Spectrum                | 7c+       | 12. Oceano                        | 6a,6a+,6b+ |
| 3. I Sabipodi (90 m.)      | 4b,5b,6a  | 13. Ti frugo nel frigo            | 6c         |
| 4. Nakita                  | 6c+,6a    | 14. Sublimazione                  | 6c+        |
| 5. Resolriama (50 m.)      | 6b,6a+    | 15. Mamy Avvista                  | 7b+        |
| 6. Freezer                 | 6a        | 16. Ghost                         | 7a+        |
| 7. Quo vadiz               | 6b        | 17. Leo & Leo                     | 6b+        |
| 8. Kleines Vergnugen       | 6a        | 18. Saltapicchio                  | 7a         |
| 9. Muro del pianto (80 m.) | 5c+,6a,6a | 19. Duamila                       | 6c         |
| 10. Schermo splendente     | 6c+       | 20. Allegro ma non troppo (60 m.) | 6b,4       |
|                            |           | 21. Vacca treno                   | 6a+        |
|                            |           | 22. Afghanistan bananistan        | 6a+        |



© coronn.com

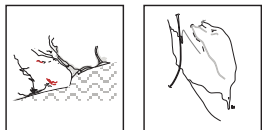

## 4.7.2. Rocca di Perti, Ombre Blu

South-West

30 m. Multi Pitch up to 100 m.

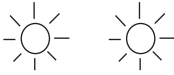

- |                                 |           |
|---------------------------------|-----------|
| 23. Per Jessica                 | 6a+       |
| 24. Free Style                  | 6a+       |
| 25. Odonett (70 m.)             | 5c,4+,5+  |
| 26. Lo diceva neruda...         | 5c        |
| 27. Menhir                      | 6a        |
| 28. Ombre Blu                   | 6a+       |
| 29. Griddonnett (60 m.)         | 6a,4b,5+  |
| 30. Ci manda nicone             | 6b+       |
| 31. Natiche frenetiche          | 6c+       |
| 32. La pertuccia (45 m.)        | 6a+,6b    |
| 33. Palaie City                 | 6b        |
| 34. ?                           | 5+        |
| 35. Le due generazioni (100 m.) | 6a+,5b,5c |
| 36. Mephisto                    | 6a+       |
| 37. Via del Prof                | 5b        |
| 38. I massici della val taro    | 6b+       |
| 39. Rockstore                   | 7c        |
| 40. Ercolino                    | 7b        |
| 41. Vista Mare                  | ?         |
| 42. Un Uomo un perche'          | ?         |
| 43. Lo Zoo e' qui               | ?         |
| 44. La lucertola e' la migliore | 6b+       |

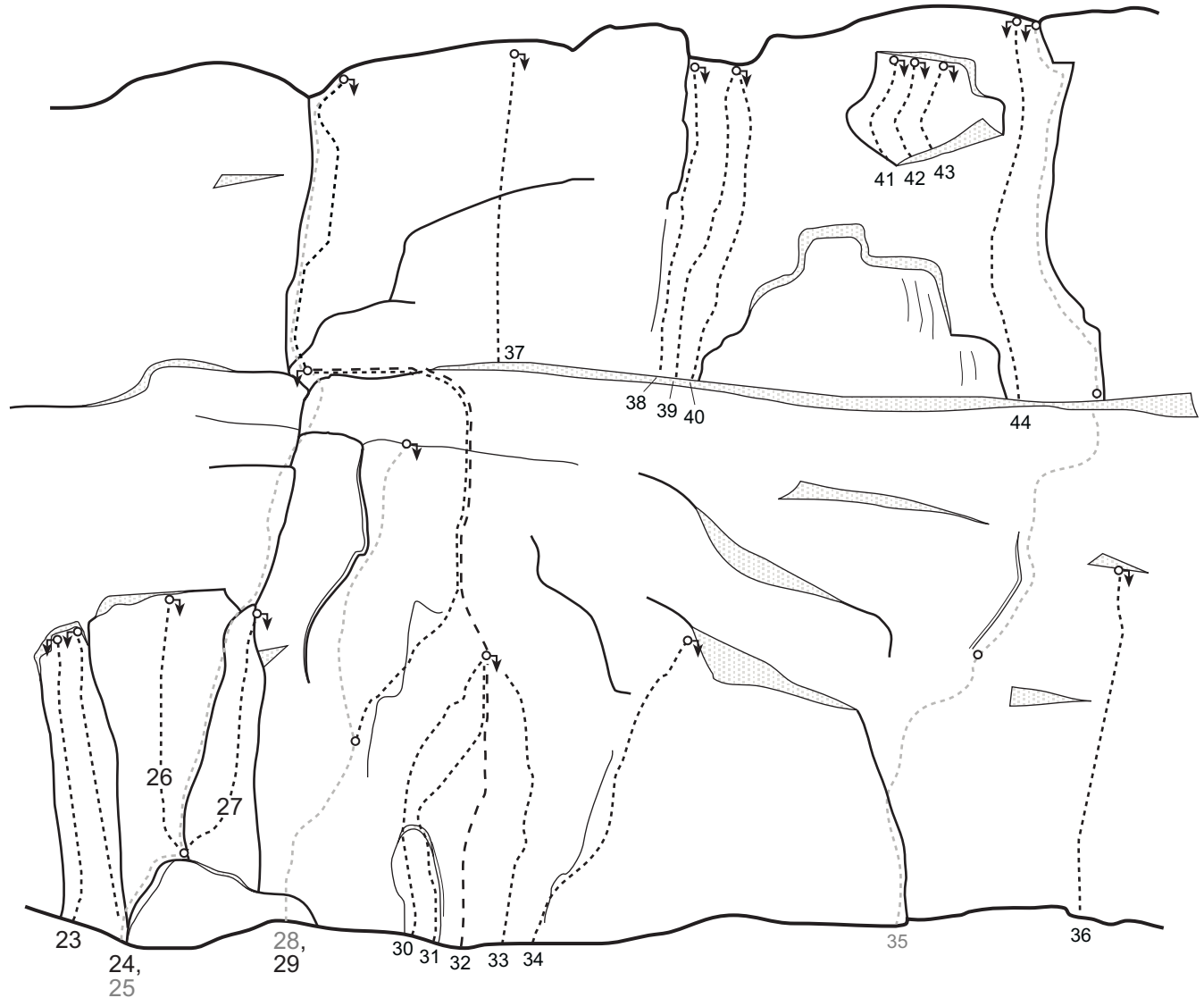

© coronn.com

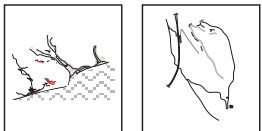

# 4.8. Rocca di Perti, Pancia dell' Elefante

South-West  
30 m.

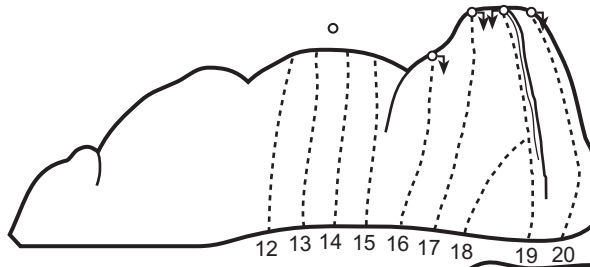
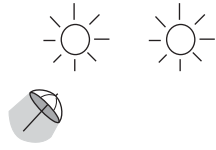

- 12. I Cuginetti (top rope) 5
- 13. La coda dell'Elefante (top rope) 5
- 14. Claudia Molina (top rope) 6a+
- 15. L'Estate sta finendo (top rope) 5b
- 16. I tuoi occhi 5c
- 17. Edeltraud 6b
- 18. Testa dell'Elefante 6c+
- 19. Spigolissimo 7a
- 20. Old Kiffer 6c

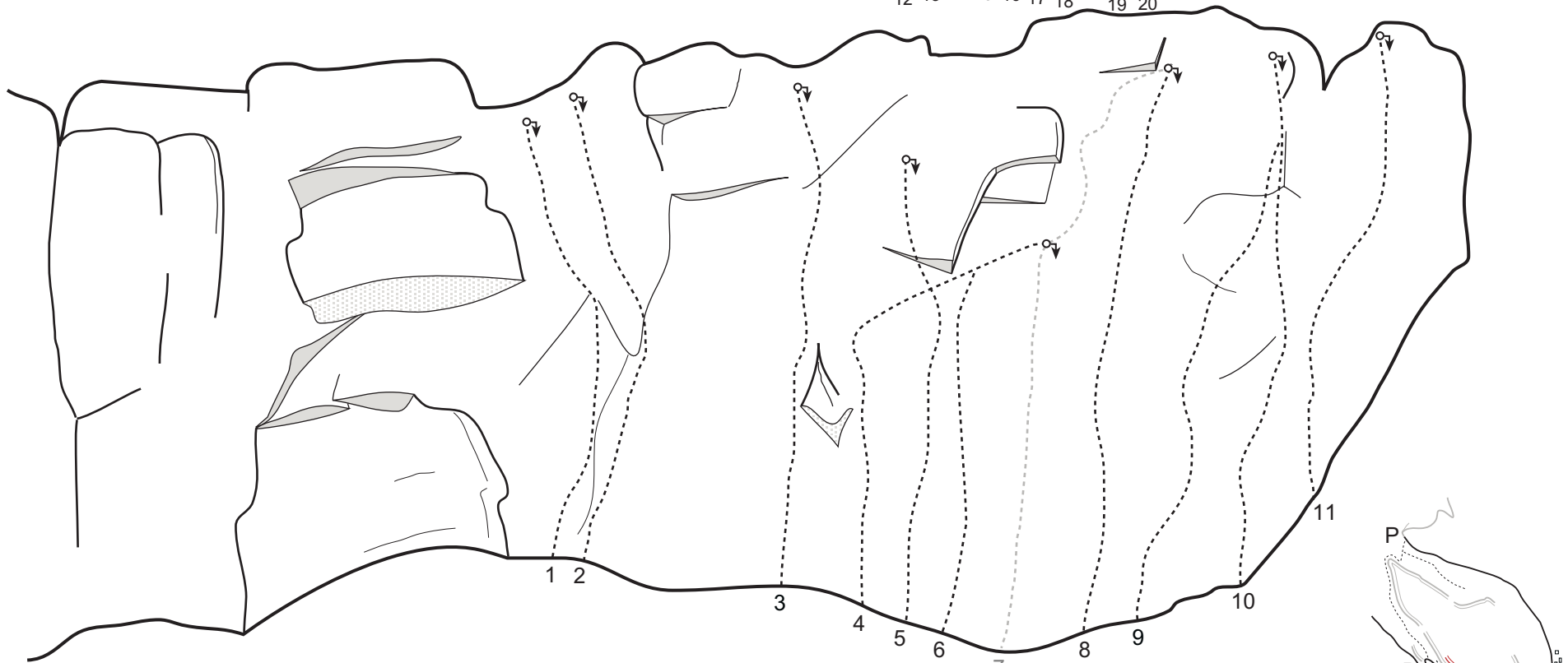

© coronn.com

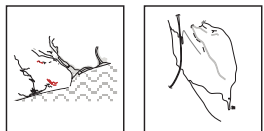

- |                             |     |                        |     |
|-----------------------------|-----|------------------------|-----|
| 1. ?                        | ?   | 7. Flippaut            | 7a  |
| 2. Cattivi pensieri         | 6c  | 8. Aspettando Godot    | 6c  |
| 3. Experience               | 6c+ | 9. Narciso e Boccadoro | 6c  |
| 4. Nemesys                  | 6b  | 10. Cardiopalma        | 6b+ |
| 5. Muesli                   | 6b+ | 11. El Talisman        | 6a+ |
| 6. Prima che il gallo canti | 7b  |                        |     |

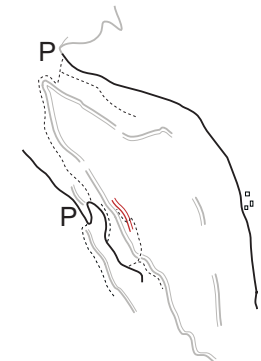

## 4.9. Rocca di Perti, Placca Piotti-Portale

South-West  
30 m. Multi pitch up to 60 m.

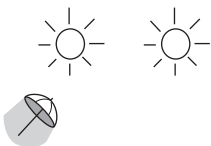

© coronn.com

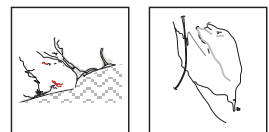

1. Argento vivo	5c	10. Il Tamburo	6a,5c	20. Bio Mechanoid	6b
2. Oro puro n.2	6b	11. Danza Saracena	5c	21. Ex cruccovia	?
3. Oro puro n.1	6b	12. Grancassa	6a	22. Lingua	?
4. Faccia di Bronzo	6b+	13. Diretta Saracena	6a+	23. Go Go	6c,7a+
5. L'Isola che non c'è	5c	14. Topi di amore	5b,4c	24. Florivana (60 m.)	5a,5b
6. I nuovi Guerrieri	7b	15. Cassulli	6a,5b+	25. Casa e falesia (60 m.)	6a,6c
7. Pilastrino Marantonio	6c	16. Incompresi	6a+,5b	26. Falesia in Casa	7a+
8. Piatto	5b	17. Uscita di sicurezza	5	27. Scherzi di Mandrake	6b+
9. La strega	?	18. Aspitta e spera	6c+,7a	28. Barba Cai	6a
		19. Pilier della concentrazione	6b,6b	29. Le paure di Lothar	6b

# 4.10. Rocca di Perti, Centrale

South-West  
30 m. Multi pitch up to 70 m.

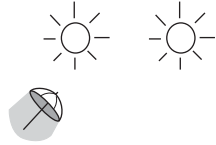

© coronn.com

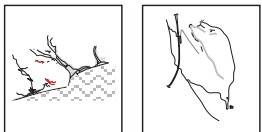

- |                        |          |                                  |          |
|------------------------|----------|----------------------------------|----------|
| 30. Abat-Jour          | 6c       | 38. C'e' nerentola? No, non c'e' | 6c       |
| 31. Regina             | 6b       | 39. Panierino Banane e...        | 7a,6b+   |
| 32. Nun me Regghe chiù | 7a       | 40. Lupi dell'Ontario            | 6c       |
| 33. Cento anch'lo      | 6c       | 41. ?                            | 5b,5c    |
| 34. Mazz Art           | 6c,7a    | 42. Patty Smith                  | 5+       |
| 35. Baby Bomba         | 7a       | 43. Diedro Gheri (70 m.)         | 5b,5b,3b |
| 36. SuperPiotti        | 6b+      | 44. Mania                        | 7a+      |
| 37. Via Mario Piotti   | 6a,6b,4b |                                  |          |

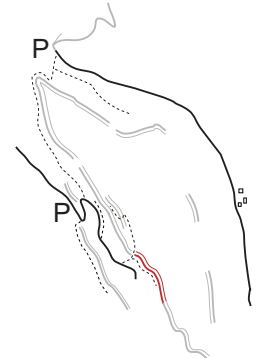

## 4.11. Rocca di Perti, Destra and Scimmiodromo

South-West

25 m. Multi pitch up to 40 m.

45. Panda	6b+
46. Mangu e Sting	6c
47. Muccalla	6c
48. Mangia per Vincere	7a
49. Blu e notte	6b
50. Giavas	6a,4
51. Passe Partout	6c+
52. La cimice nel sacchetto	6a+
53. Tic Tac	6a+
64. Preistorici messaggi	6a
55. Ah shiftare	6a
56. Pow Wow	6b
57. A mani a perti	6c+
58. Arabesque	6a

### Scimmiodromo

Follow the track further to the right, pass the stone-quarry. You will find a crag with the following excellent routes (from left to right);

1. Ombra	8b
2. La danza dei Topi	7a+
3. Tant...	7a
4. El Giaguaro	7a+
5. Sacrilegio	6b
6. Maschio da nido	6a
7. Donna di Tana	6b
8. Come gli Schiavi	6b

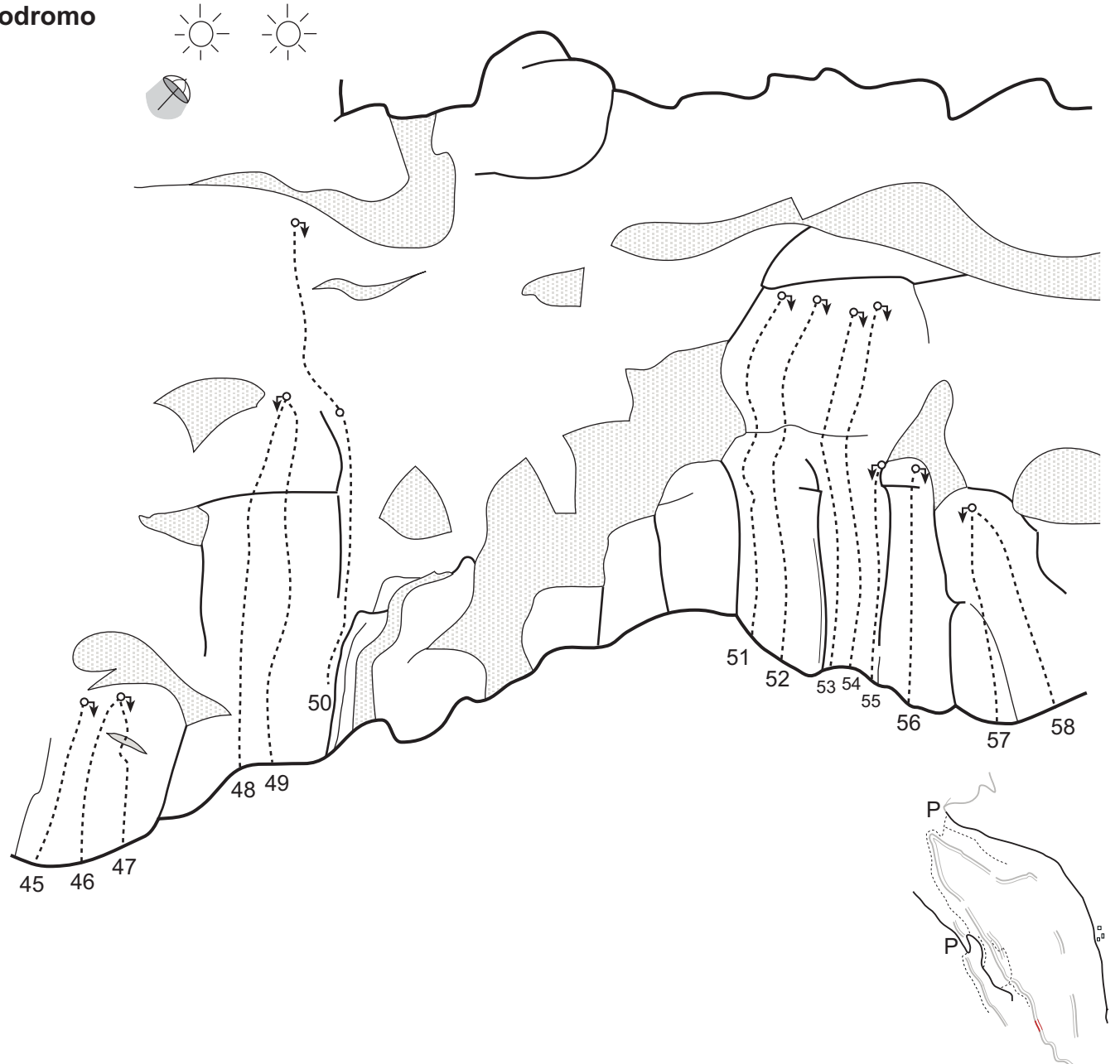

© coronn.com

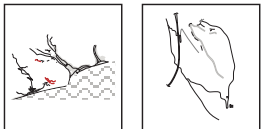

## 5 and 6. Monte Sordo and Placca delle Casa Valle, Key-map



6.1.

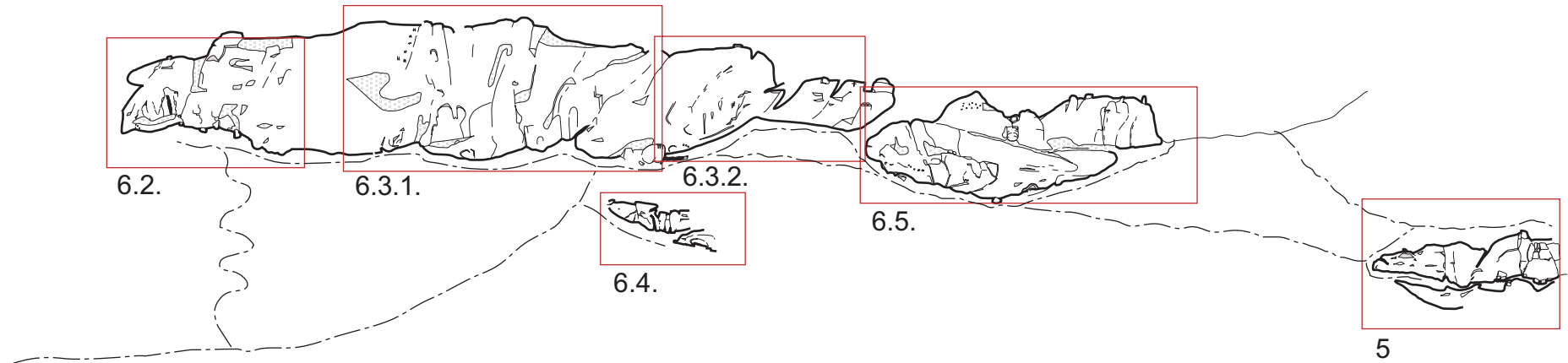

### How to find the crags:

Drive from Finale Ligure in the direction of the highroad. Turn right in the direction of Finalborgo and turn left before the city wall in the direction of Calice Ligure. Turn right in the direction of the Castle "Gavone", continue and pass the Church (the road gets quite small here). A couple of kilometres later you will see some nice houses with high finish to the right, park and walk in between these houses to reach crag no. 5 or 6.5. Continue to the end of the road to reach the rest of those crags. See separate descriptions about each crag.

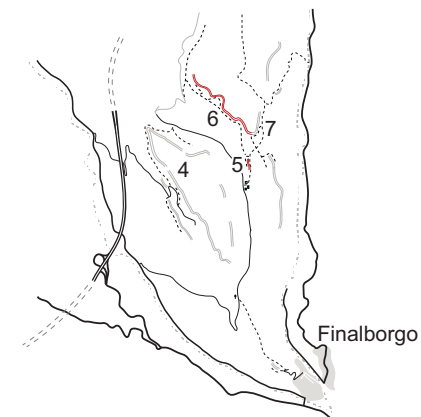

© coronn.com

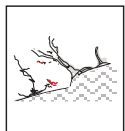

## 5. Placca delle Casa Valle

N 44° 11.662'  
EO 08° 19.263'

West  
15 m.

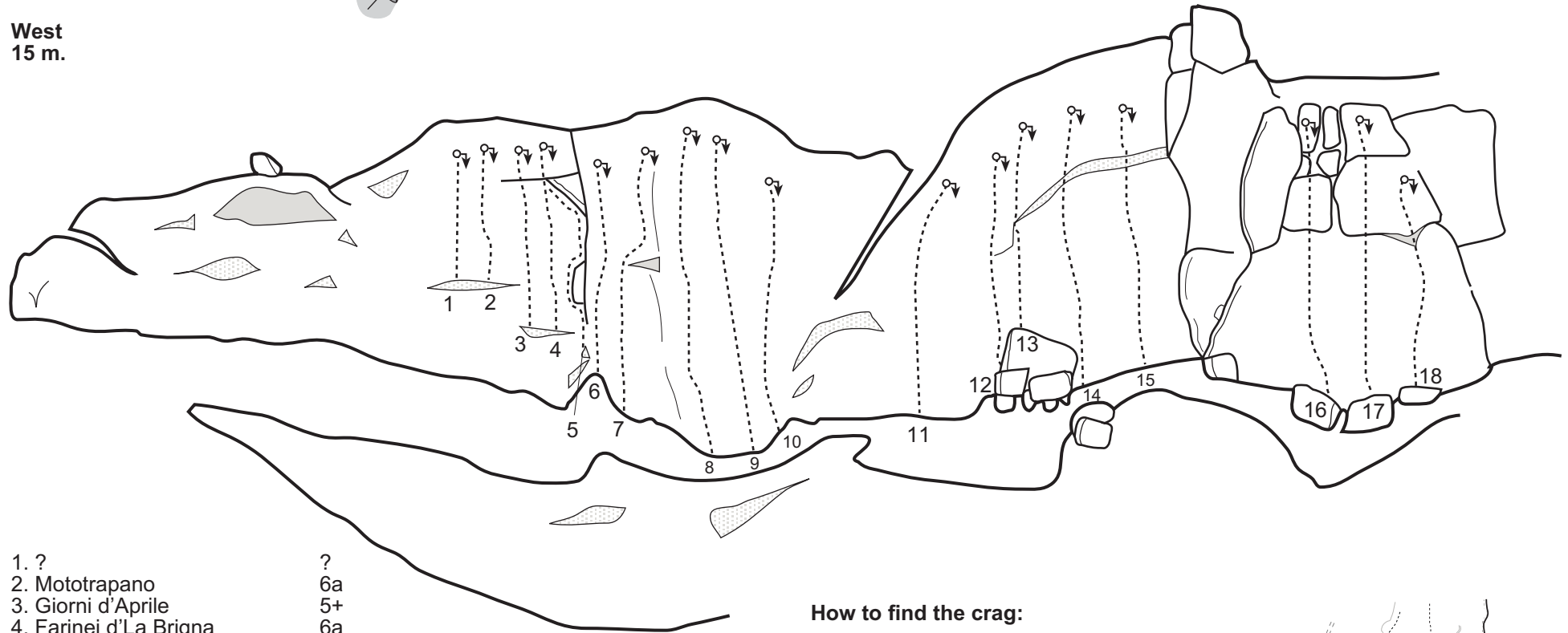
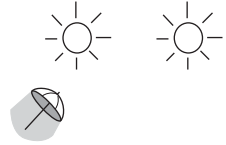

- |                        |    |                      |
|------------------------|----|----------------------|
| 1. ?                   | ?  |                      |
| 2. Mototrapano         | 6a |                      |
| 3. Giorni d'Aprile     | 5+ |                      |
| 4. Farinei d'La Brigna | 6a |                      |
| 5. ?                   | ?  |                      |
| 6. Frenulo rotto       | 6c |                      |
| 7. Elena Valentini     | 7a |                      |
| 8. 37/60               | 6a | 10. Nonno pierino    |
| 9. 2 dita di rovescio  | 6a | 11. Sandopilnsky     |
|                        |    | 12. Stai sbagliando  |
|                        |    | 13. La faina         |
|                        |    | 14. Let's get it up  |
|                        |    | 15. Ben Hur          |
|                        |    | 16. Nosferatu        |
|                        |    | 17. Black Sabbath    |
|                        |    | 18. Requiem aeternam |

© coronn.com

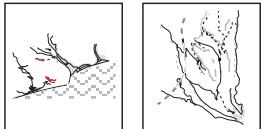

### How to find the crag:

Drive from Finale Ligure in the direction of the highroad. Turn right in the direction of Finalborgo and turn left before the city wall in the direction of Calice Ligure. To reach 4.1. and 4.2. Turn right in the direction of the Castle "Gavone", continue and pass the Church (the road gets quite small here). A couple of kilometres later you will see some nice houses with high finish to the right, park and walk in between these houses. After the house follow the marked track (three red spots). The track pass on top of the crag, continue until you passed it, then turn left in a T-junction and walk around down to the crag.

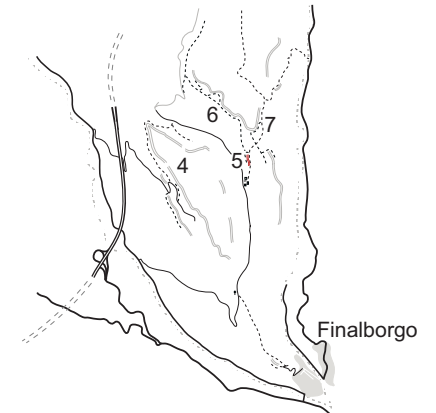



## 6.1. Pilastrino Mirovino

West  
30 m.

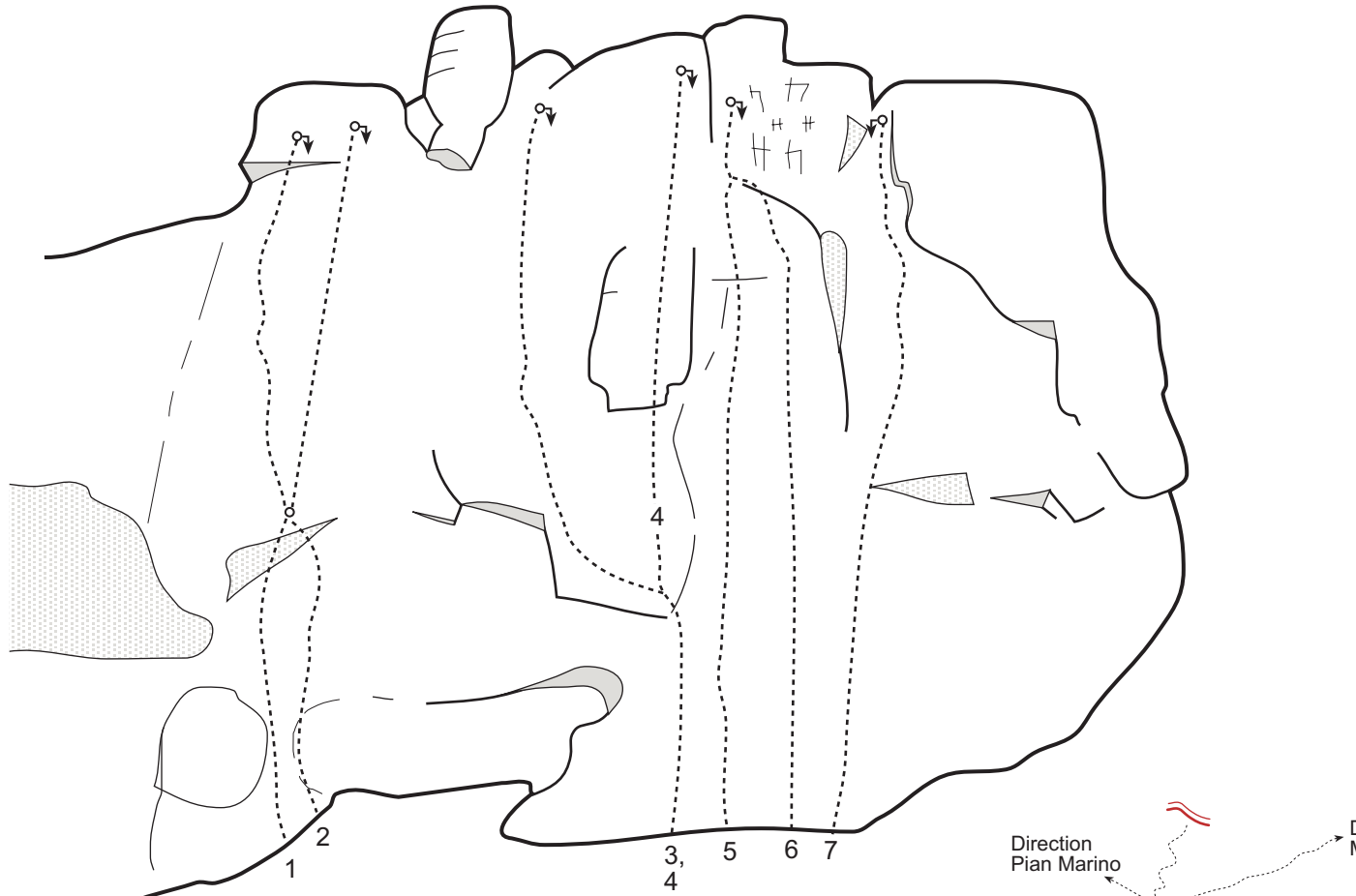
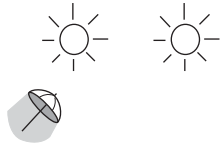

### How to find the crag:

Drive from Finale Ligure in the direction of the highroad. Turn right in the direction of Finalborgo and turn left before the city wall in the direction of Calice Ligure. To reach 4.1. and 4.2. Turn right in the direction of the Castle "Gavone", continue and pass the Church (the road gets quite small here). Continue until the public road finish and park. Continue by foot on a private road in the direction of the houses. Pass the houses and follow the road that now turns sharp left. About 150 meters after you have passed the last house, turn slightly right on to a wide track. After about 75 meters you meet a T-junction just after a "dry" brook, turn right to reach Monte Sordo, continue straight forward about 50 meters and then find your way to the right to reach this crag.

© coronn.com

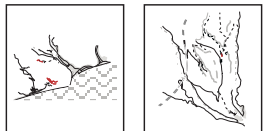

- |                        |     |
|------------------------|-----|
| 1. Effetto sassofrasso | 6a+ |
| 2. Ringo Boys          | 6b+ |
| 3. ?                   | 5c  |
| 4. Via del diedro      | 5c  |
| 5. Pilastrino Mirovino | 5c  |
| 6. Maracana'           | 6b  |
| 7. ?                   | 5c  |

Direction  
Pian Marino

Direction  
Monte Sordo

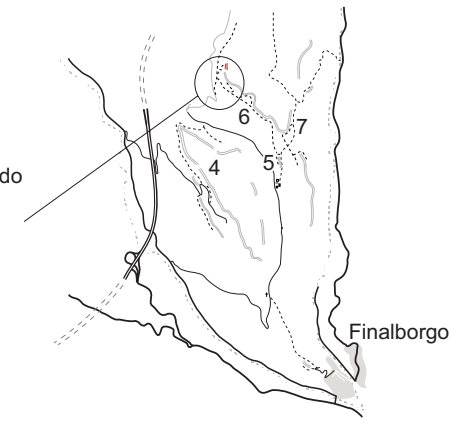

## 6.2. Monte Sordo, Alveare e Placca di Mu

West, South-West  
30 m.

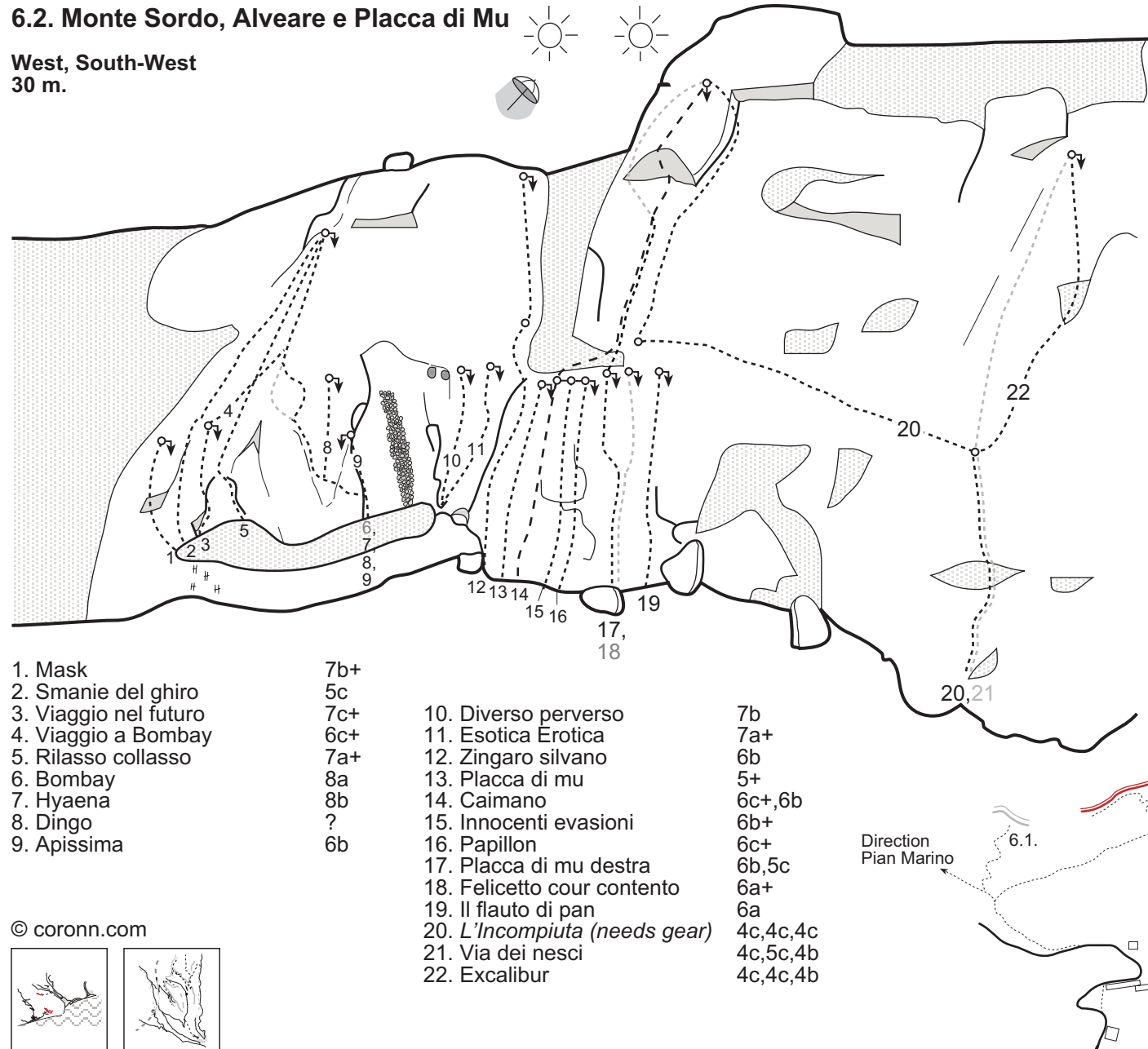

- |                                      |          |
|--------------------------------------|----------|
| 1. Mask                              | 7b+      |
| 2. Smanie del ghiro                  | 5c       |
| 3. Viaggio nel futuro                | 7c+      |
| 4. Viaggio a Bombay                  | 6c+      |
| 5. Rilasso collasso                  | 7a+      |
| 6. Bombay                            | 8a       |
| 7. Hyaena                            | 8b       |
| 8. Dingo                             | ?        |
| 9. Apissima                          | 6b       |
| 10. Diverso perverso                 | 7b       |
| 11. Esotica Erotica                  | 7a+      |
| 12. Zingaro silvano                  | 6b       |
| 13. Placca di mu                     | 5+       |
| 14. Caimano                          | 6c+,6b   |
| 15. Innocenti evasioni               | 6b+      |
| 16. Papillon                         | 6c+      |
| 17. Placca di mu destra              | 6b,5c    |
| 18. Felicetto cour contento          | 6a+      |
| 19. Il flauto di pan                 | 6a       |
| 20. <i>L'Incompiuta</i> (needs gear) | 4c,4c,4c |
| 21. Via dei nesci                    | 4c,5c,4b |
| 22. Excalibur                        | 4c,4c,4b |

© coronn.com

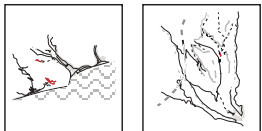

### How to find the crag:

Drive from Finale Ligure in the direction of the highroad. Turn right in the direction of Finalborgo and turn left before the city wall in the direction of Calice Ligure. To reach 4.1. and 4.2. Turn right in the direction of the Castle "Gavone", continue and pass the Church (the road gets quite small here). Continue until the public road finish and park. Continue by foot on a private road in the direction of the houses. Pass the houses and follow the road that now turns sharp left. About 150 meters after you have passed the last house, turn slightly right on to a wide track. After about 75 meters you meet a T-junction just after a "dry" brook, turn right and continue 200-250 meters until you locate yourself just below the crag, then walk straight up to it.

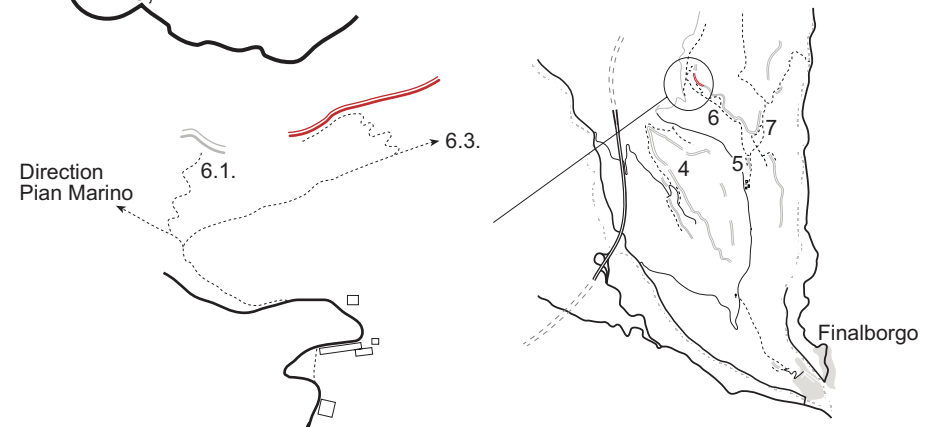

### 6.3.1. Monte Sordo, Centrale

South, South-West  
35 m. Multi-Pitch up to 60 m.

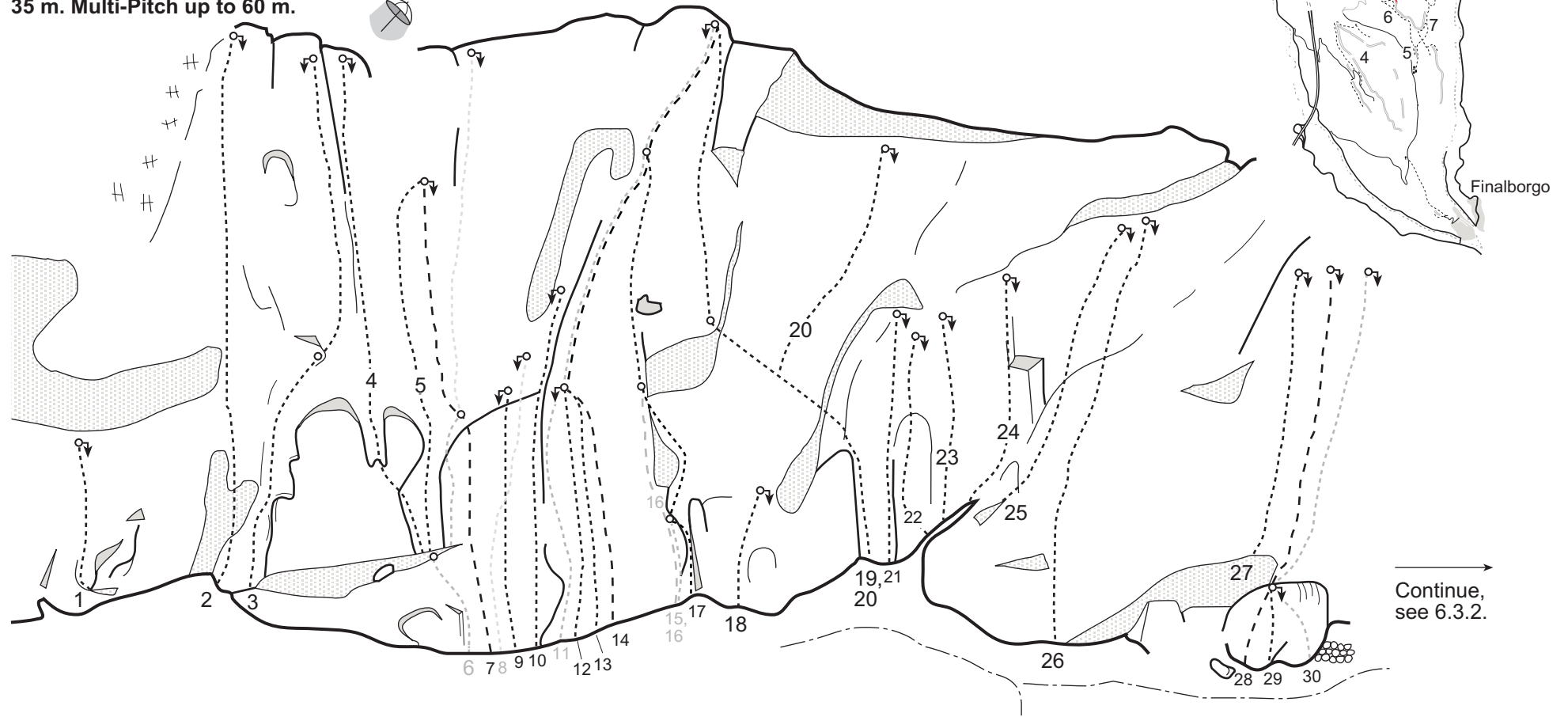
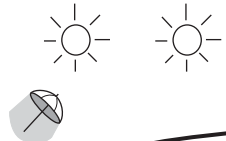

Continue,  
see 6.3.2.

© coronn.com

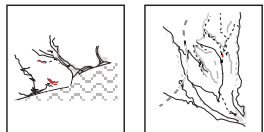

- |                                  |          |                           |       |                           |       |
|----------------------------------|----------|---------------------------|-------|---------------------------|-------|
| 1. Gianpieratissimo Oh Oho Ohh   | 6b       | 11. L'Arco dei guatechi   | 5c,5b | 21. L'Isola di giava      | 6b+   |
| 2. Pilastro Mattia               | 5c       | 12. Vedova Nera           | 6b+   | 22. Absidal               | 6a+   |
| 3. Il Gatto selvaggio            | 5,6a     | 13. Venerdì               | 6b    | 23. I Meteopatici         | 6a+   |
| 4. Estranea                      | 7a       | 14. Placca delle Bimbe    | 6a,5b | 24. La tana dell'Anguilla | 6b+   |
| 5. Futura                        | 6a,6b+   | 15. Livelli di biacaggine | 5c    | 25. Piperyta Patty        | 6c+   |
| 6. Fessura Oliva                 | 5b,6a,5c | 16. Umma Gumma            | 6b+   | 26. Via normale           | 4     |
| 7. Fedeli alla Linea             | 7b,6b+   | 17. Sipario di Pietra     | 5b,5c | 27. Sioula                | 6a    |
| 8. Franco e Ketty                | 6b       | 18. Overdose              | 6b    | 28. Super Bostik          | 4c,5c |
| 9. Giusy                         | 6b+      | 19. Lama Tagliente        | 6b,6b | 29. ?                     | 6a    |
| 10. Introspezione elettrostatica | 6b       | 20. Pilastro sospeso      | 5+    | 30. Mistero               | 4c,6a |

## 6.3.2. Monte Sordo, Lo Specchio

South-West  
35 m. Multi-Pitch up to 50 m.

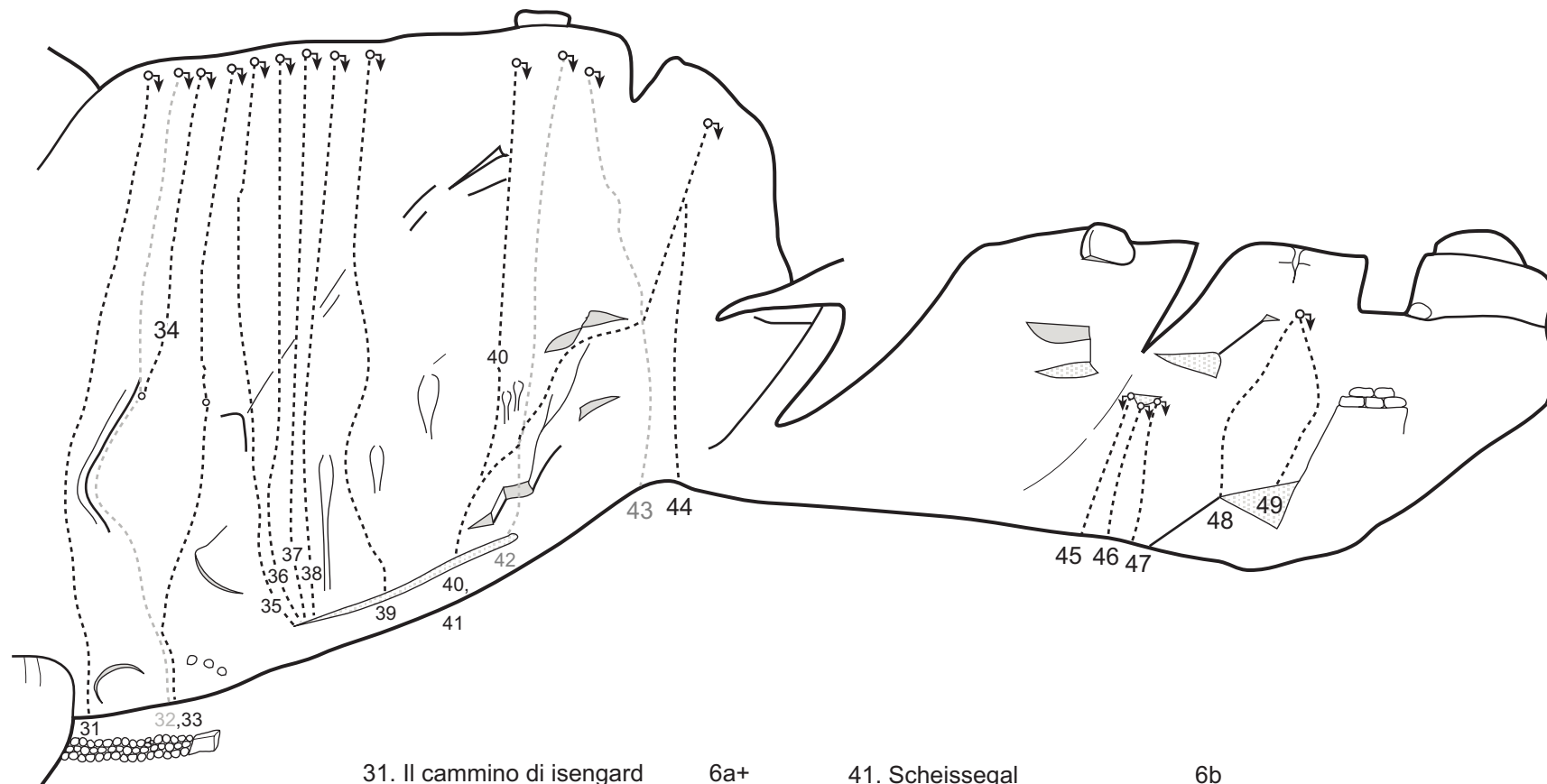
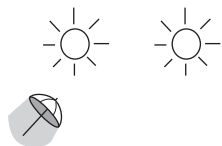

© coronn.com

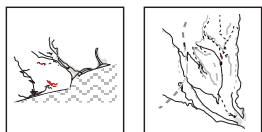

31. Il cammino di isengard	6a+	41. Scheissegal	6b
32. La bella Eowin	5b,6a+	42. Game over	7a+
33. Lo specchio di Galadriel	5c,6a	43. Free Nelson Mandela	6b+
34. L'Orchetto Zotichetto	6a+	44. Così la va	6a
35. Out of Zucca	7a+	45. U can	6a
36. Free - Tto misto	6c+	46. Labirinth	6b+
37. Colite&Gaz-Trite	7a	47. Strike	6b
38. Schizzechea	7a	48. Be Bop a Lula	7b
39. Vivere di Rabbia	7b	49. ?	6a
40. Bastante fanaticos	7a		

## 6.4. Monte Sordo, I Coralli

N 44° 11.806'  
EO 08° 19.061'

West  
15 m.

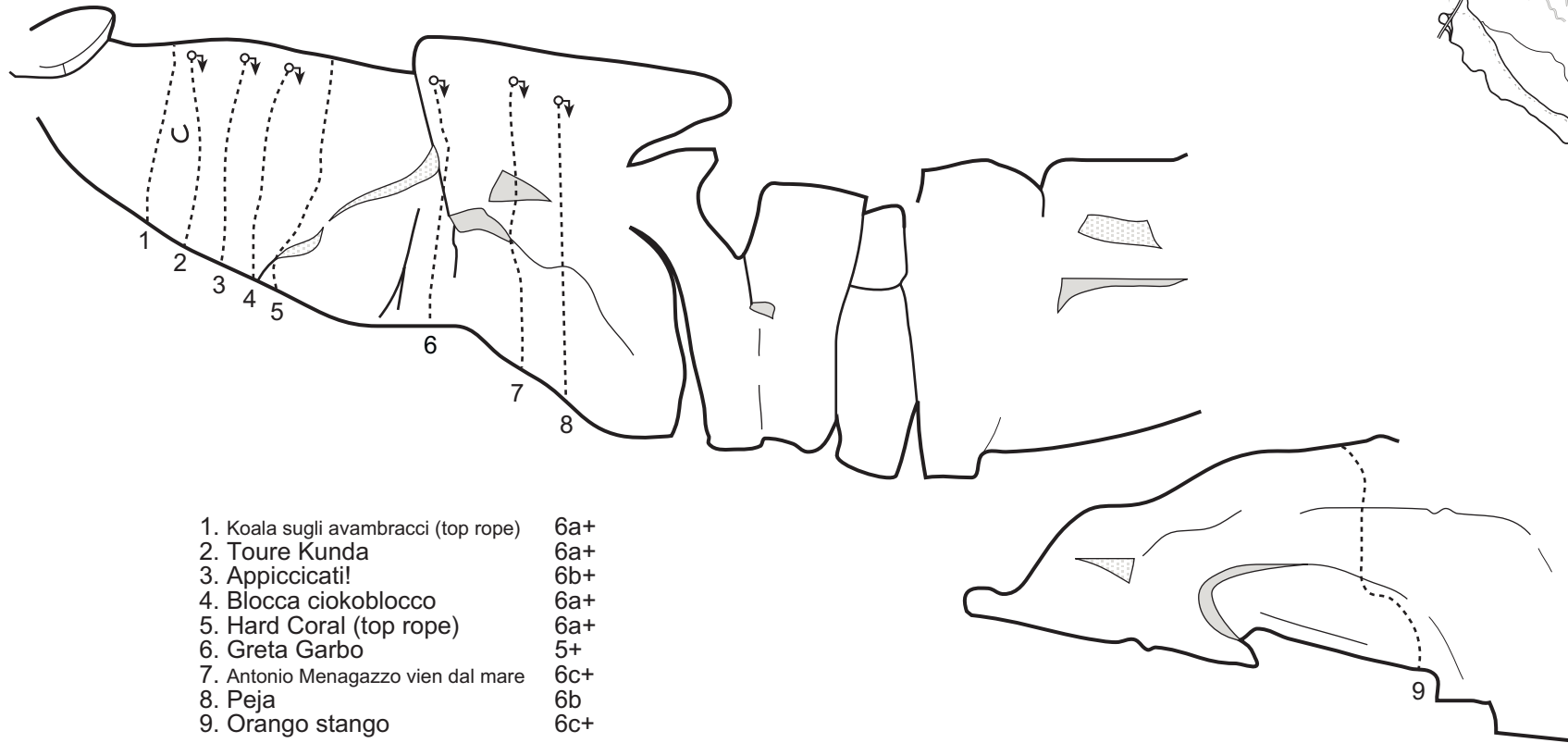
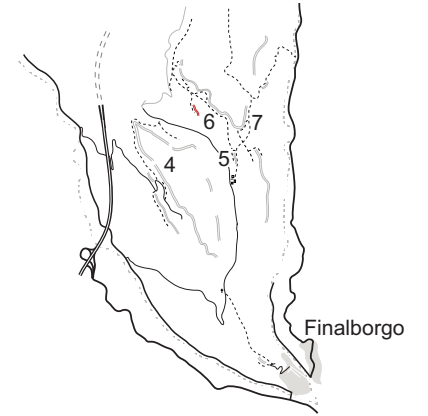
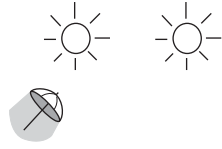

- |                                      |     |
|--------------------------------------|-----|
| 1. Koala sugli avambracci (top rope) | 6a+ |
| 2. Toure Kunda                       | 6a+ |
| 3. Appiccicati!                      | 6b+ |
| 4. Blocca ciokoblocco                | 6a+ |
| 5. Hard Coral (top rope)             | 6a+ |
| 6. Greta Garbo                       | 5+  |
| 7. Antonio Menagazzo vien dal mare   | 6c+ |
| 8. Peja                              | 6b  |
| 9. Orango stango                     | 6c+ |

© coronn.com

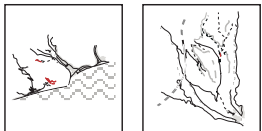

## 6.5.0. La Parete Dimenticata, Keymap

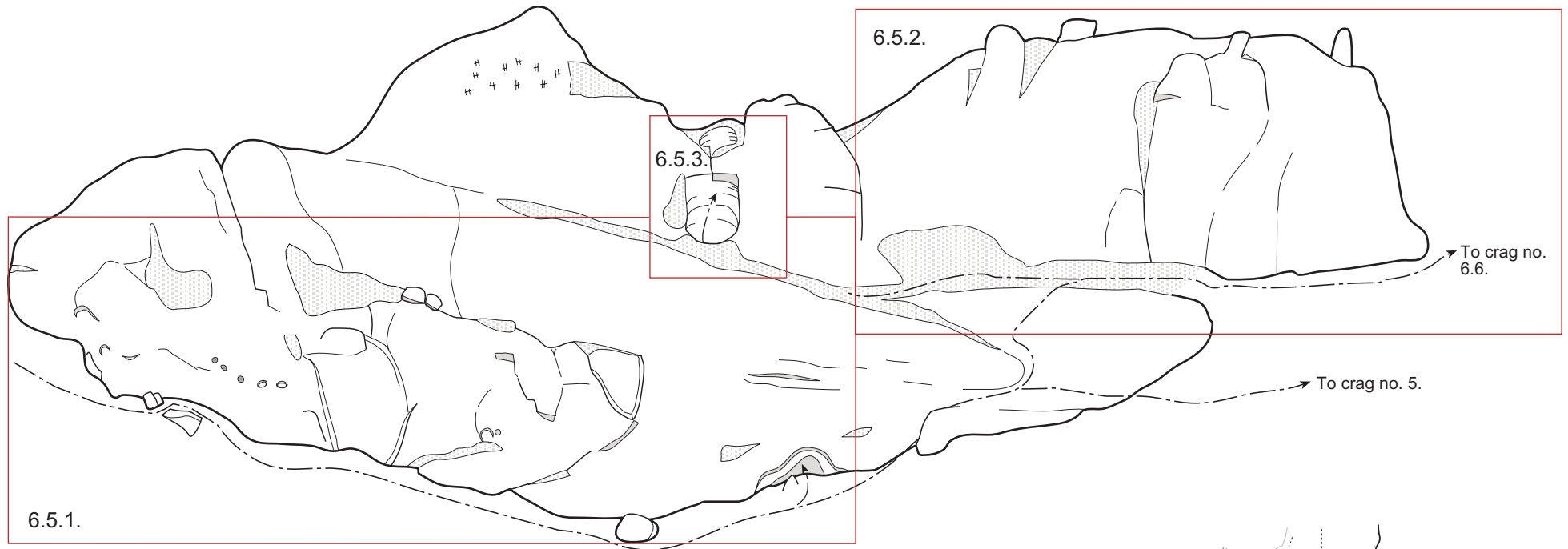

### How to find the crag:

Drive from Finale Ligure in the direction of the highroad. Turn right in the direction of Finalborgo and turn left before the city wall in the direction of Calice Ligure. To reach 4.1. and 4.2. Turn right in the direction of the Castle "Gavone", continue and pass the Church (the road gets quite small here). Continue until the public road finish and park. Continue by foot on a private road in the direction of the houses. Pass the houses and follow the road that now turns sharp left. About 150 meters after you have passed the last house, turn slightly right on to a wide track. After about 75 meters you meet a T-junction just after a "dry" brook, turn right and pass crag no. 6.2. to 6.4. in order reach this crag.

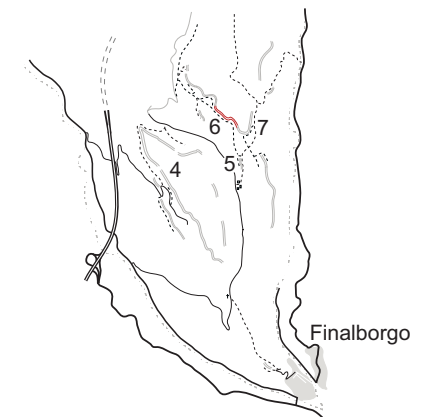

© coronn.com

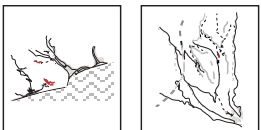

# 6.5.1. La Parete Dimenticata

N 44° 11.759'  
EO 08° 19.173'

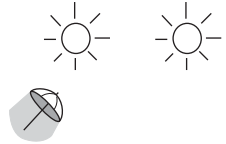

West  
30 m. Multi Pitch up to 70 m.



© coronn.com

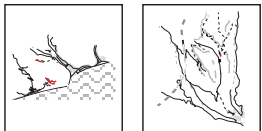

Continue,  
see 6.5.2.

## 6.5.2. La Parete Dimenticata

West  
18 m.

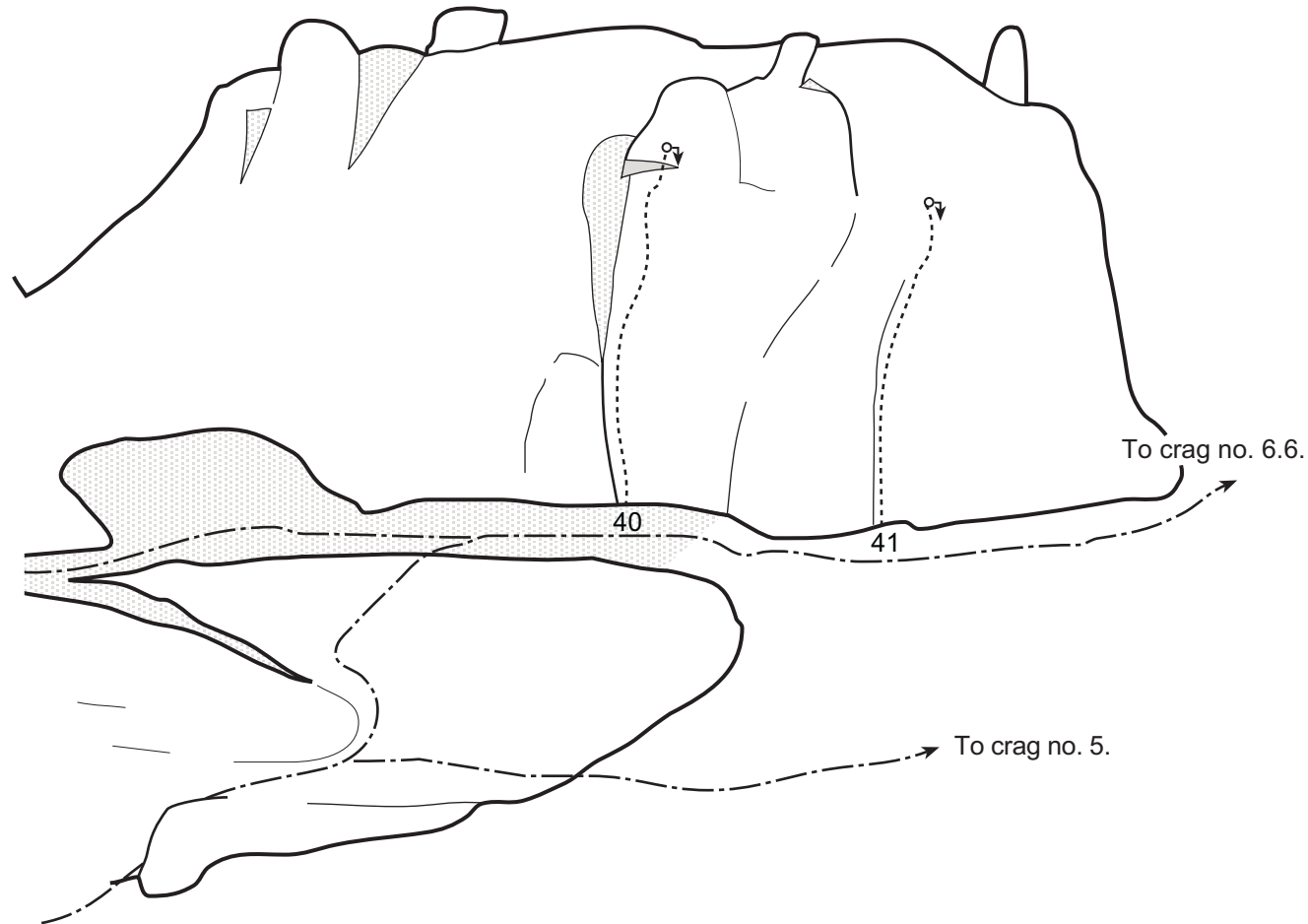
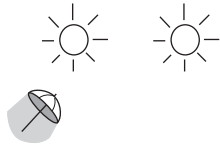

1. Katanga	5c
2. Cannolo alla Panna	5c
3. Ten dur molla nen	6b
4. La Brigna l'e sempre la Brigna	6a+
5. U massacan da falesia	6a+
6. Pimpiripettanuse	5c
7. Raschiascogli	6a
8. I conquistatori dell'Inutile	6b
9. Fanfara Tulip	6b
10. Progressive	7a
11. Compagni di merende	6a+
12. Ciro ci ripensa	5c
13. Il conte ugolino	5c
14. L'Amore e' un attimo	5c
15. La canna tra le mani	6b+
16. Viaggio nel Bus del Gnao	5c
17. Duchessa	5c
18. I Pasticcioni	5c
19. L'Altre Madre	6a
20. Figa Mariuccia	6a+
21. Bingo Bongo	6a
22. Sandokan	6b
23. Via del Petrolio (60 m.)	5b,4c
24. I Fighetti del clan	6a+
25. Friends	5c
26. U Furestu	6a+
27. Los Angeles	7a
28. Controfobia (60 m.)	5b,5c
29. Dateci una mano	6b
30. Piacevolmente insensibili	6b
31. Fa che duri	6a
32. La spada di damocle	5c
33. Capriccio diagonale (70 m.)	4b,5b,4c
34. La voglia matta	6a+
35. ?	6a,6a+
36. Un minotauro in ballerine	7a
37. Le corna non fan peso	7a+
38. Figowitz	7a
39. Mutabaruka	6b
40. Scudo Grigio	6c+
41. Spigolo dell'Etrusco	7a

© coronn.com

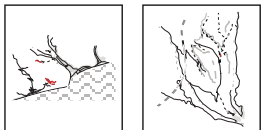



### 6.5.3. Grotta dell'Edera

25 m.



- |                             |     |
|-----------------------------|-----|
| 1. ?                        | 6a+ |
| 2. El Diablo                | 7b  |
| 3. Mosaiko                  | 7c+ |
| 4. ?                        | ?   |
| 5. Per uscire dalle tenebre | 6c+ |
| 6. Rank Xerox               | 6c+ |
| 7. Camera con vista         | 7a  |
| 8. Bombolo                  | 6b  |
| 9. Shokada                  | 6b  |
| 10. Lubna                   | 7b  |

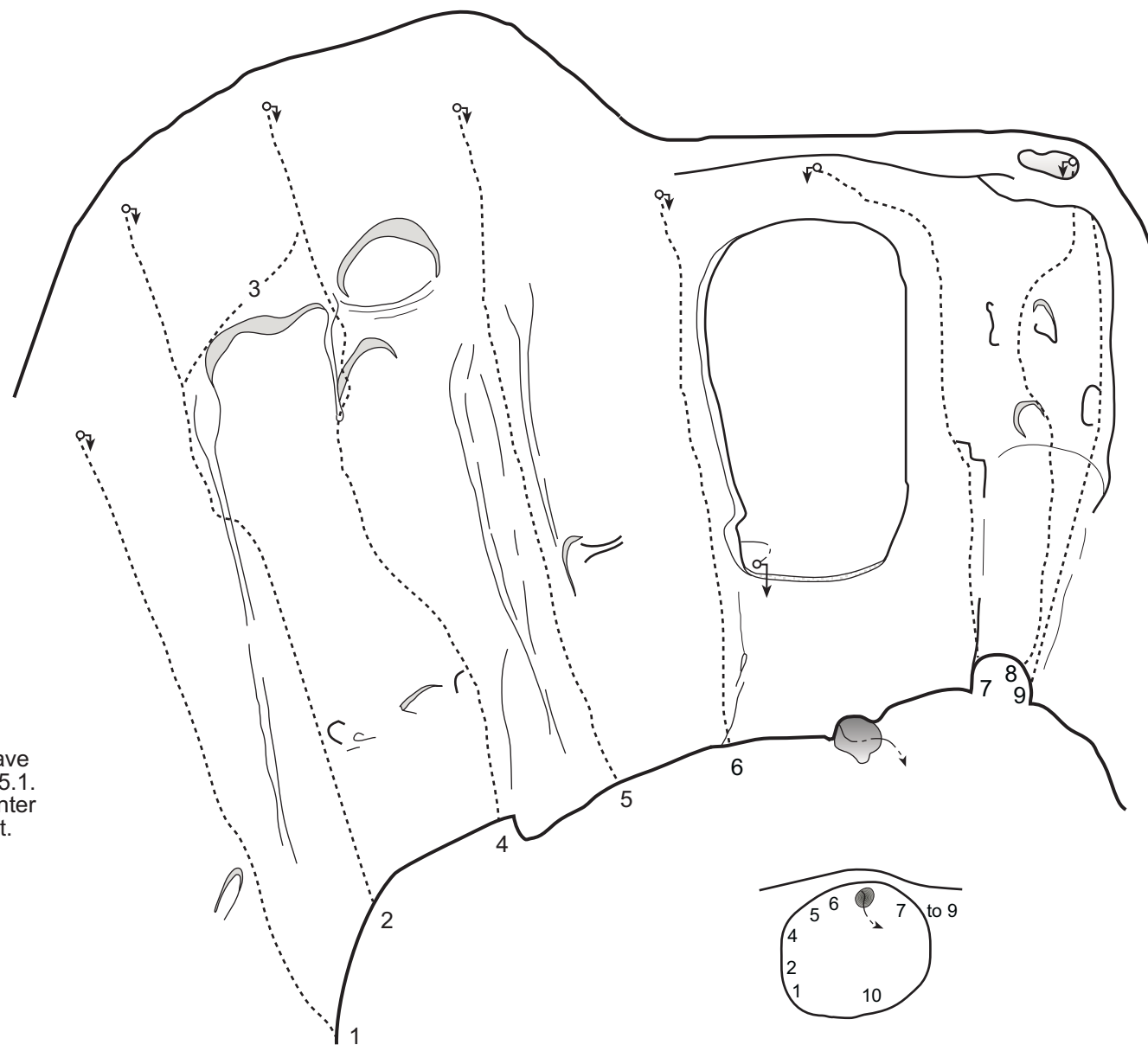

#### How to find the crag:

To find this spectacular open cave, enter the cave where you find route no. 36 and 37 on Topos 6.5.1. Follow the rope through the cave and you will enter this crag from bellow. You can also abseil into it.

© coronn.com

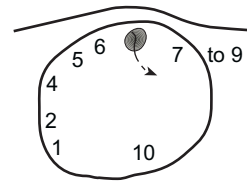
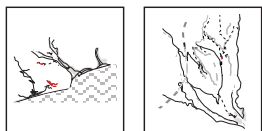

## 6.6. Antri Rossi



N 44° 11.753'  
EO 08° 19.255'

South  
25 m.

### How to find the crag:

Drive from Finale Ligure in the direction of the highroad. Turn right in the direction of Finalborgo and turn left before the city wall in the direction of Calice Ligure. Turn right in the direction of the Castle "Gavone", continue and pass the Church (the road gets quite small here). A couple of kilometres later you will see some nice houses with high finishes to the right, park and walk in between these houses. After the house follow the marked track (three red spots), pass crag no. 5 and continue to the crest. Turn left in the cross on to a small track that leads to this crag.

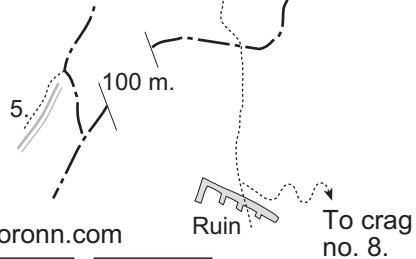
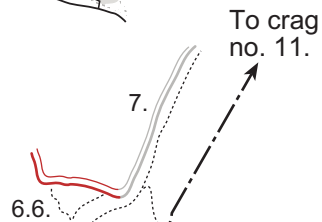
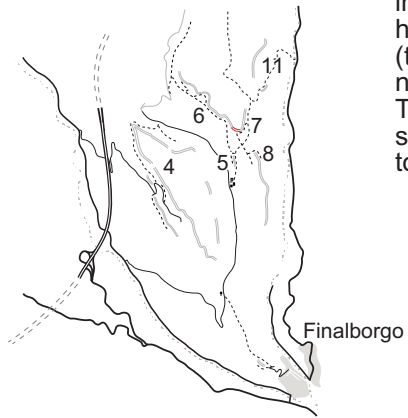

© coronn.com

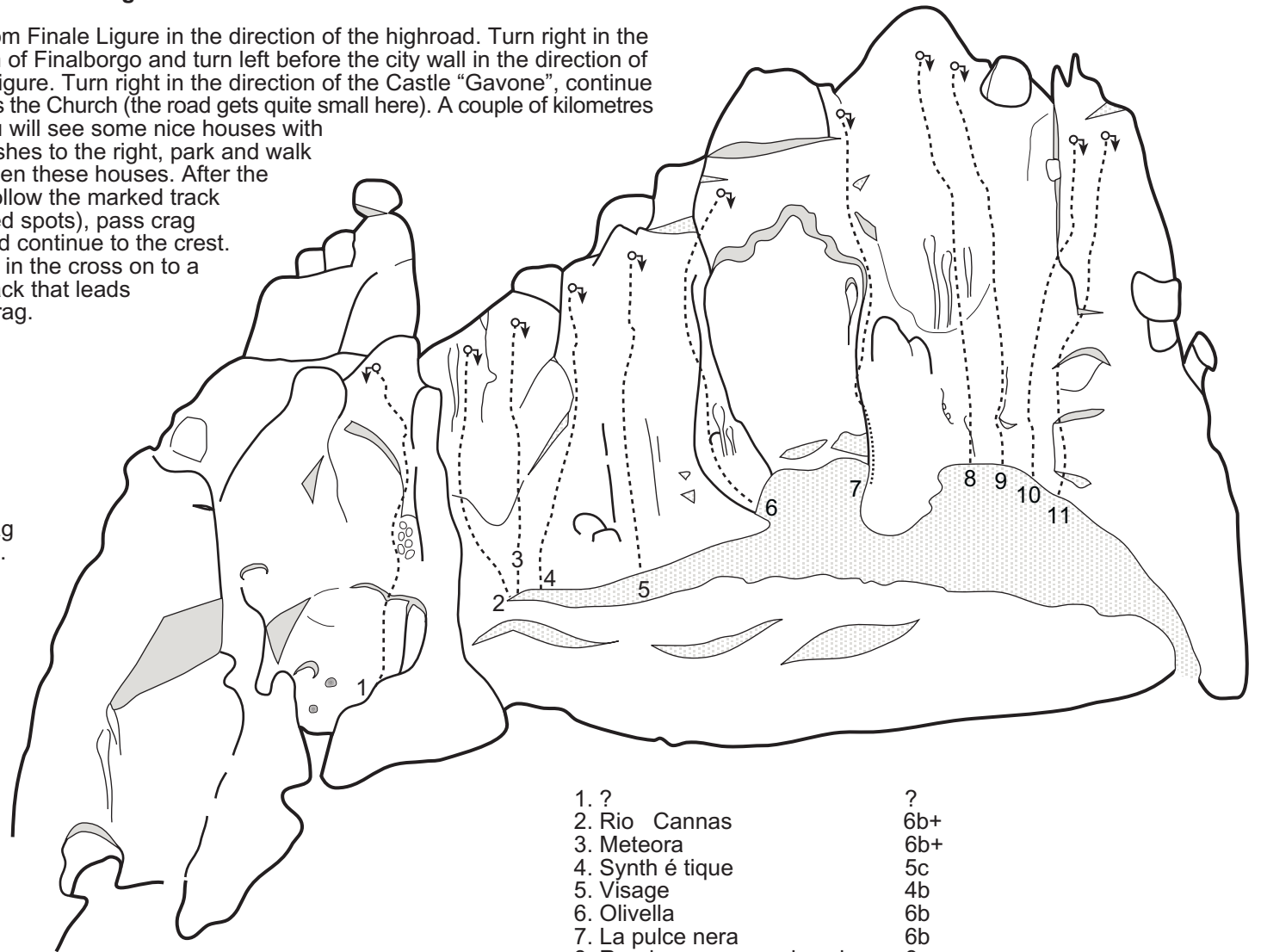
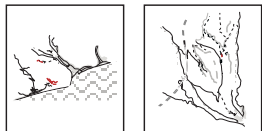

- |                            |     |
|----------------------------|-----|
| 1. ?                       | ?   |
| 2. Rio Cannas              | 6b+ |
| 3. Meteora                 | 6b+ |
| 4. Synth é tique           | 5c  |
| 5. Visage                  | 4b  |
| 6. Olivella                | 6b  |
| 7. La pulce nera           | 6b  |
| 8. Render vous avec le vol | 6c+ |
| 9. Grigio relativo         | 6b  |
| 10. La linea d'ombra       | 6b+ |
| 11. Super goccia           | 6a  |

# 7.1. Bric Scimarco

East  
40 m. Multi Pitch up to 80 m.

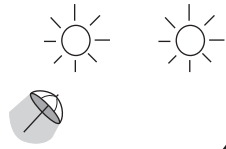

- |                           |           |
|---------------------------|-----------|
| 1. Le mie fragole         | ?         |
| 2. Brutto anatroccolo     | 6b+       |
| 3. Valle Argentina        | 6c        |
| 4. Due Calzini            | 6b+       |
| 5. Inviata speciale       | 5c        |
| 6. Petit four             | 5c        |
| 7. Albi (80 m.)           | 4,6a,5b   |
| 8. Tifone                 | 7a        |
| 9. Ciclone                | 7b        |
| 10. Ti voglio             | 6c        |
| 11. Dubbio                | 6a,6a     |
| 12. Il senso del dovere   | 6a+       |
| 13. ?                     | 5c        |
| 14. Panico e salamico     | 6b+       |
| 15. Anciu                 | 6c+       |
| 16. Canvaria              | ?         |
| 17. Pilastro della regina | 5c        |
| 18. Festa del lavoro      | 7a        |
| 19. Il Buco nero          | 6c+       |
| 20. Al di là del Mare     | 6c        |
| 21. Imagine (70 m.)       | 6a+,5+,6b |
| 22. False promesse        | 6b+       |
| 23. Fessurina             | 6b        |
| 24. Katana                | 7a+       |

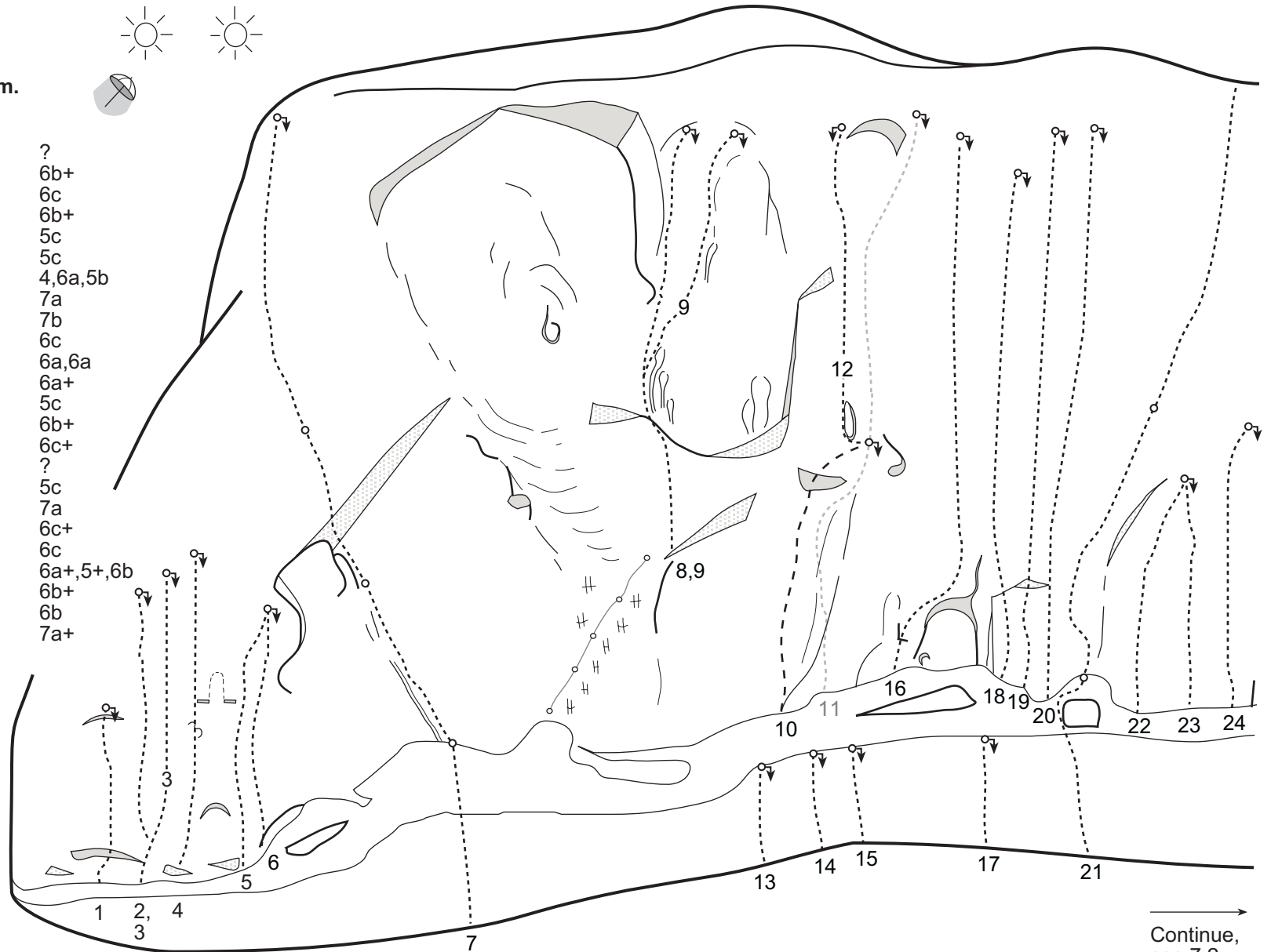

© coronn.com

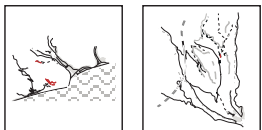

Continue,  
see 7.2.

## 7.2. Bric Scimarco

East  
30 m. Multi Pitch up to 90 m.

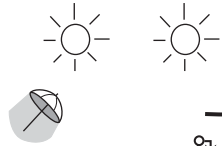

- 25. Mikroba
- 26. Mitica
- 27. Raggi Cosmici
- 28. Via del traverso (90 m.)
- 29. Il diritto
- 30. Stefano Cuneo (70 m.)
- 31. Pietra stregata
- 32. Cengia allegra
- 33. Dita da cani
- 34. Alapaga
- 35. Mix mas Ala
- 36. Orbita Quadrada
- 37. Afa letale
- 38. Tutti questi
- 39. Hyperzot
- 40. Ghenaelle (80 m.)
- 41. Il Cinghiale (60 m.)
- 42. Mirada
- 43. Bauhaus (80 m.)
- 44. Uccidi lo Schnzauzer
- 45. The cure
- 46. Macabrus
- 47. Tenedo' (45 m.)
- 48. Pilastro del re (60 m.)
- 49. Bronsky beat (50 m.)

- 7b
- 6c
- 7a+
- 5c,6b,5c
- 7a+
- 6b+,6b,5c
- 6b+
- 7a
- 6c
- 7a+
- 7c
- 7a
- 6c
- 6c
- 7a
- 5c,6b,4
- 5b,5c
- 6c
- 6a+,6a+,6a
- 6a
- 6b+
- 7a
- 6a,5c
- 6a,5c
- 6a+,6c

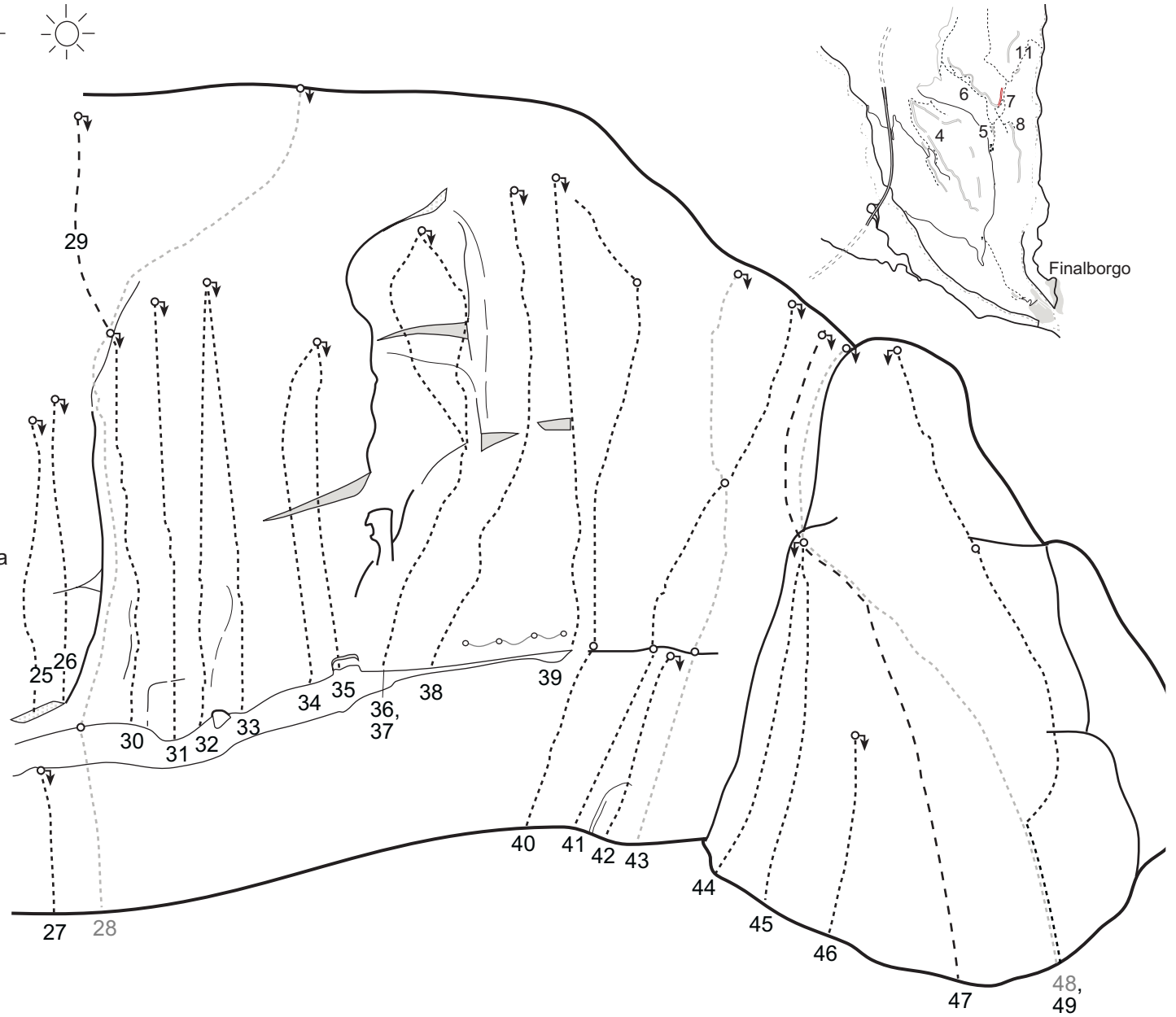

© coronn.com

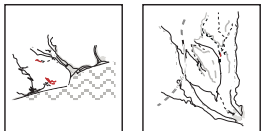

# 8. S. Antonio

N 44° 11.703'  
EO 08° 19.281'

North-East  
30 m.

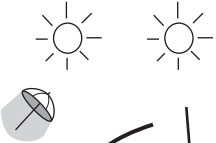

- 1. Devastavo
- 2. Il blasfemo
- 3. La cattiva strada
- 4. Simpatico...
- 5. Piera sei sincera
- 6. Fuck Totum
- 7. Attila

- 6c
- 7a
- 6a
- 6b
- 6b
- 7a+
- 7a

© coronn.com

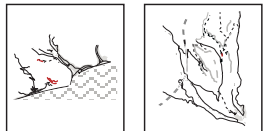

## How to find the crag:

Drive from Finale Ligure in the direction of the highroad. Turn right in the direction of Finalborgo and continue through the town on small roads. Follow signposts for Feglino. Just before a T-junction (the road to Orco and the Refuge) you will find a "Agriturismo" farmhouse on the left side of the road. Park here, cross the small bridge and follow the track for 20 minutes to find this crag. It is also possible to reach this crag from the next valley, then follow the description that you find for crag 6.6.

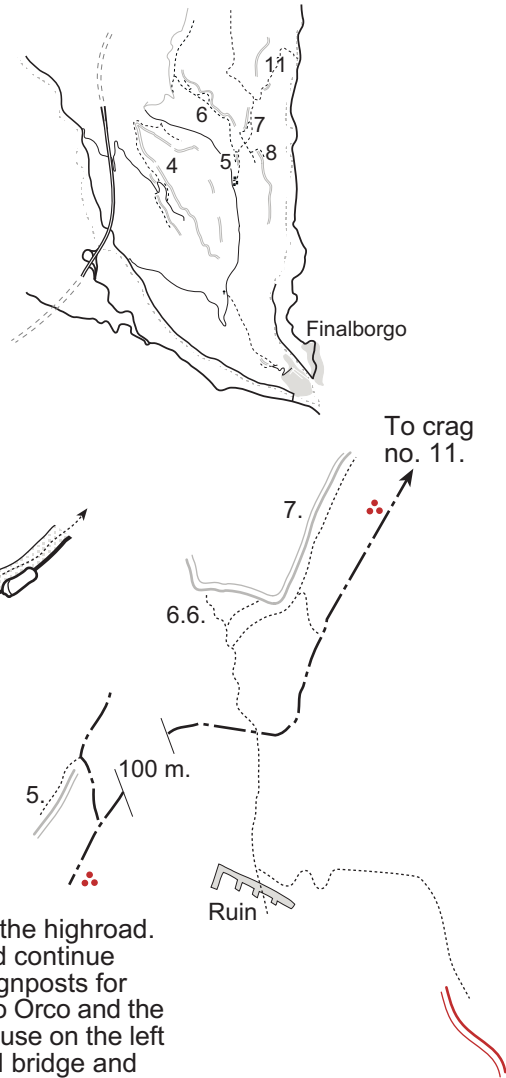

# 9. Paretina di Pian Marino

N 44° 12.359'  
EO 08° 19.020'

West, North-West  
25 m.

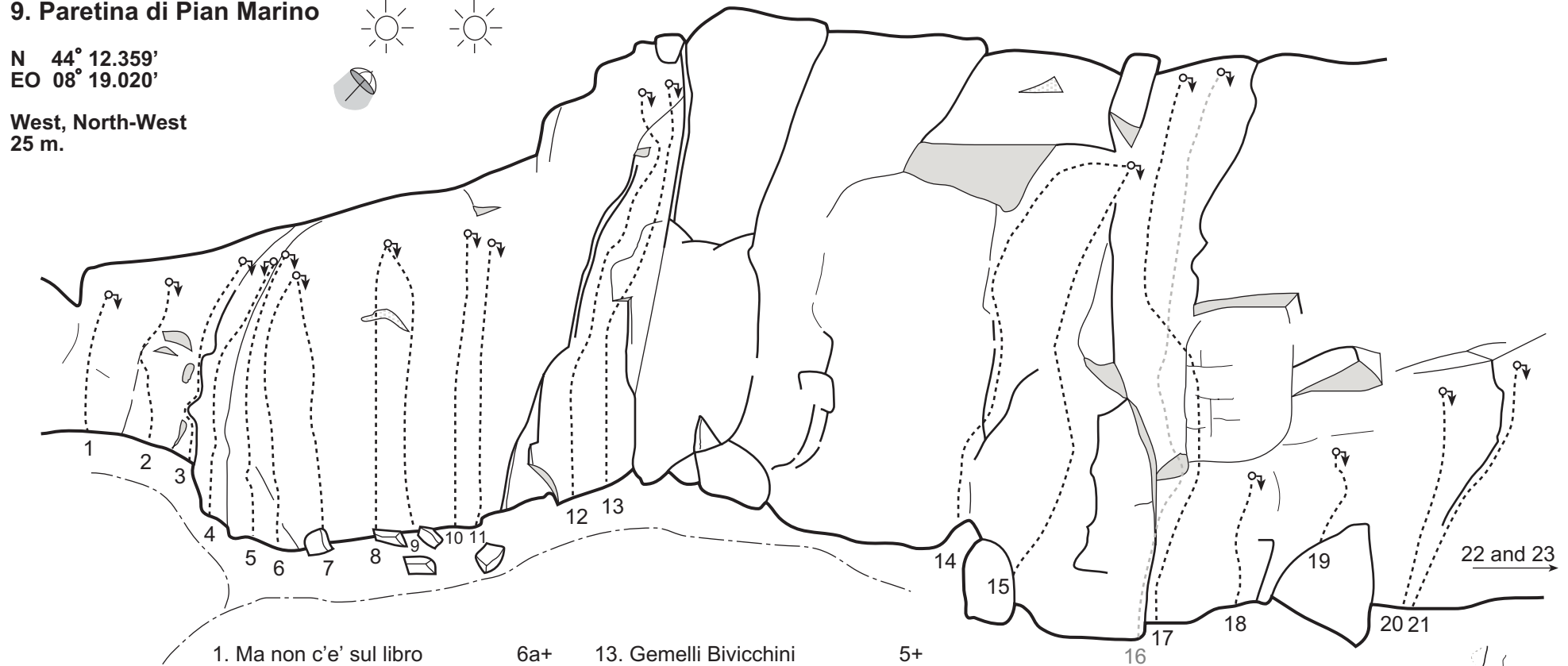
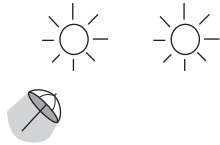

To crag no. 10

- |                                 |     |                                |    |
|---------------------------------|-----|--------------------------------|----|
| 1. Ma non c'e' sul libro        | 6a+ | 13. Gemelli Bivicchini         | 5+ |
| 2. No friends                   | 6a+ | 14. ?                          | 5b |
| 3. Brutta                       | 3   | 15. Il rientro dei Maghi       | 6b |
| 4. Merlo di Nottingham          | 4   | 16. Der heilige flat           | 6c |
| 5. A.A.A. Fessura cercasi       | 5b  | 17. I Gioielli di Val          | 6a |
| 6. Equinox                      | 5c  | 18. Spit and Love              | 5+ |
| 7. Calma e gesso                | 4c  | 19. Come vuoi                  | 6a |
| 8. Sgorby superpall             | 5b  | 20. Pet's Shop Boys            | 5c |
| 9. La Rovere                    | 5c  | 21. Stranger                   | 6b |
| 10. Natta natta chiudi la patta | 5c  | <b>20 meters to the right;</b> |    |
| 11. Roxy Bar                    | 6a  | 22. Children                   | 4b |
| 12. Gemelli Ribelli             | 5+  | 23. Goriomatic                 | 5c |

### How to find the crag:

Drive from Finale Ligure in the direction of the highroad. Turn right in the direction of Finalborgo and turn left before the city wall in the direction of Calice Ligure. To reach 4.1. and 4.2. Turn right in the direction of the Castle "Gavone", continue and pass the Church (the road gets quite small here). Continue until the public road finish and park.

Continue by foot on a private road in the direction of the houses. Pass the houses and follow the road that now turns sharp left. About 150 meters after you have passed the last house, turn slightly right on to a wide track. After about 75 meters you meet a T-junction just after a "dry" brook, continue straight forward and pass the big open grass meadows and turn right on a wide track to the crag.

© coronn.com

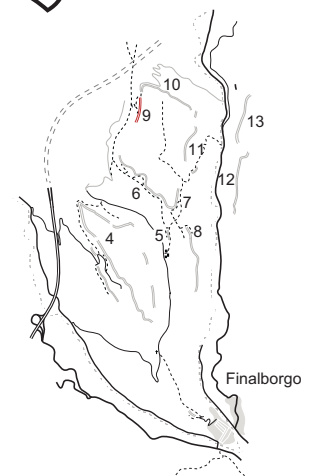
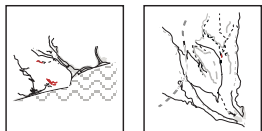

## 10.0. Bric del Frate, Key-map

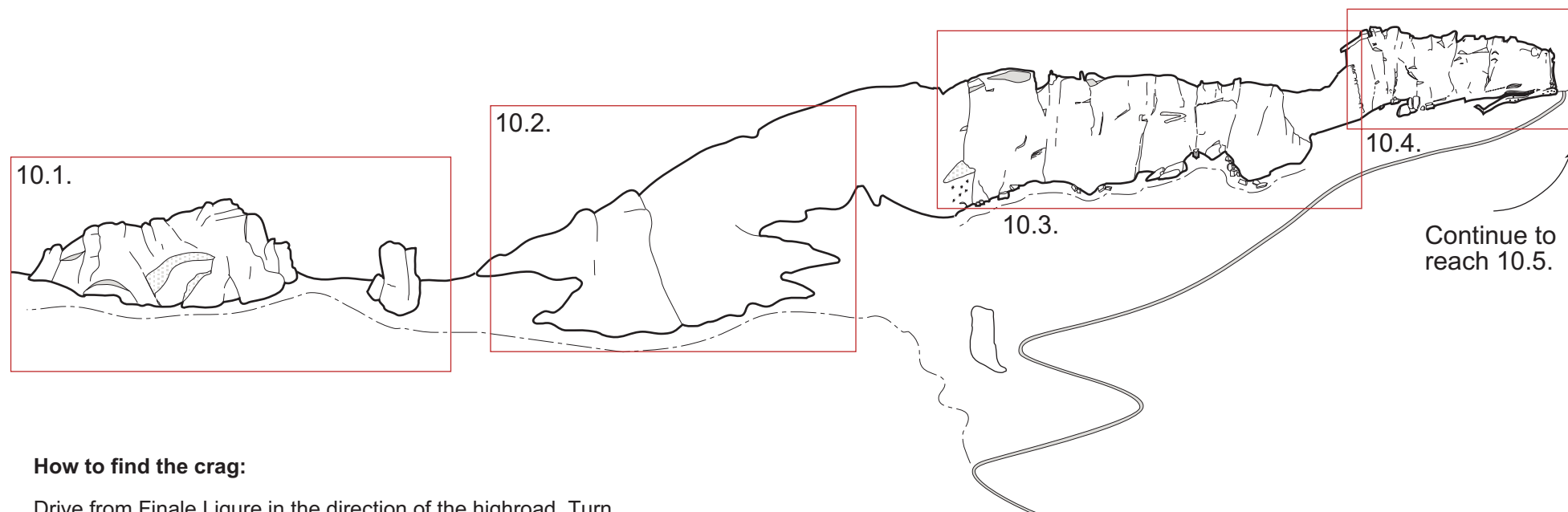

### How to find the crag:

Drive from Finale Ligure in the direction of the highroad. Turn right in the direction of Finalborgo and continue through the town on small roads. Follow signposts for Feglino. Just before a T-junction (the road to Orco and the Refuge) you will find a "Agriturismo" farmhouse on the left side of the road. Park here or at a lay-bay near the T-junction. Continue on the road in the direction of Feglino. About 150 meters after you have passed the T-junction (Orco) you will find a clay-covered road to the left. Follow this. To reach 10.1. and 10.2. leave the road and follow the track in the direction of the crags, to reach 10.3 to 10.5., follow the road until you reach the crag (10.5. is located after the crest, on the north-west side of this crag.) Continue on the track if you want to reach crag no. 9. from this side.

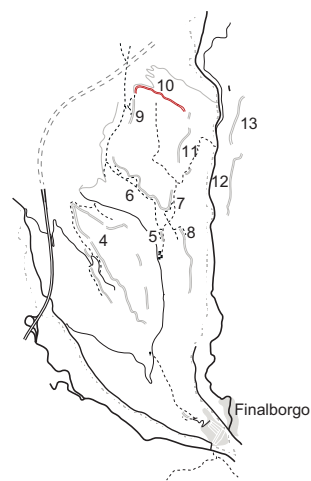

© coronn.com

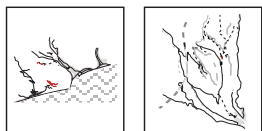

**10.1. Bric del Frate**  
**Parete dell'Aquila e Caffettiera**

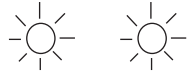

North-East  
 25 m. Multi Pitch 35 m.

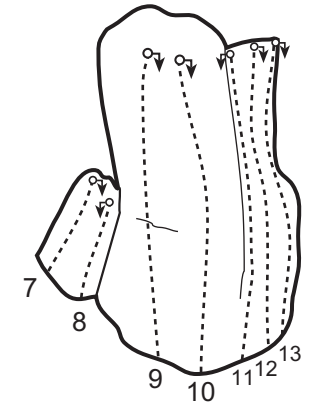
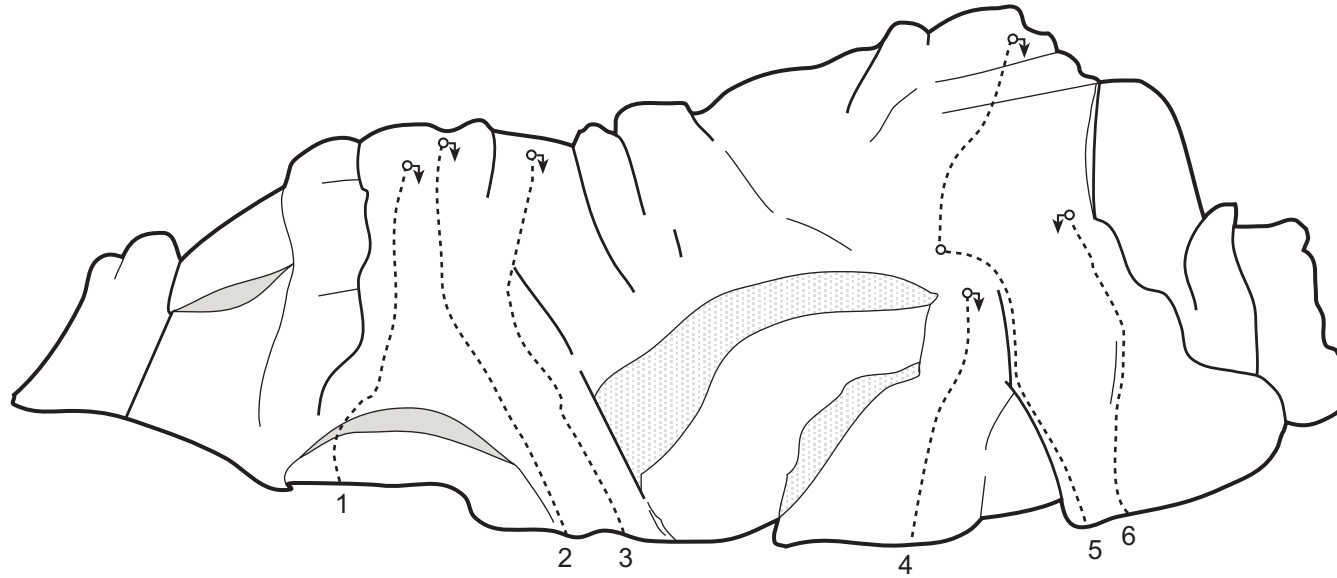

- |                                   |       |
|-----------------------------------|-------|
| 1. Guerre lontane                 | 6b+   |
| 2. Dedalo                         | 6a    |
| 3. Le balene possono stare sedute | 7a    |
| 4. Banditi                        | 5c    |
| 5. ?                              | 4c,5b |
| 6. Sometimes knocks               | 6b    |
| 7. Tensoplast                     | 6b+   |
| 8. Normale alla Caffettiera       | 6a    |
| 9. Sveltina                       | 7a    |
| 10. Esperando d'Escobar           | 6c    |
| 11. Me retruevo a fornigar        | 6c    |
| 12. Pannocchie                    | 5b    |
| 13. Peppineu                      | 6b+   |

© coronn.com

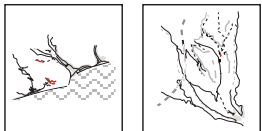



## 10.2. Bric del Frate, Settore Sinistro

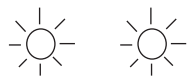

North-East  
15 m. Multi Pitch up to 90 m.

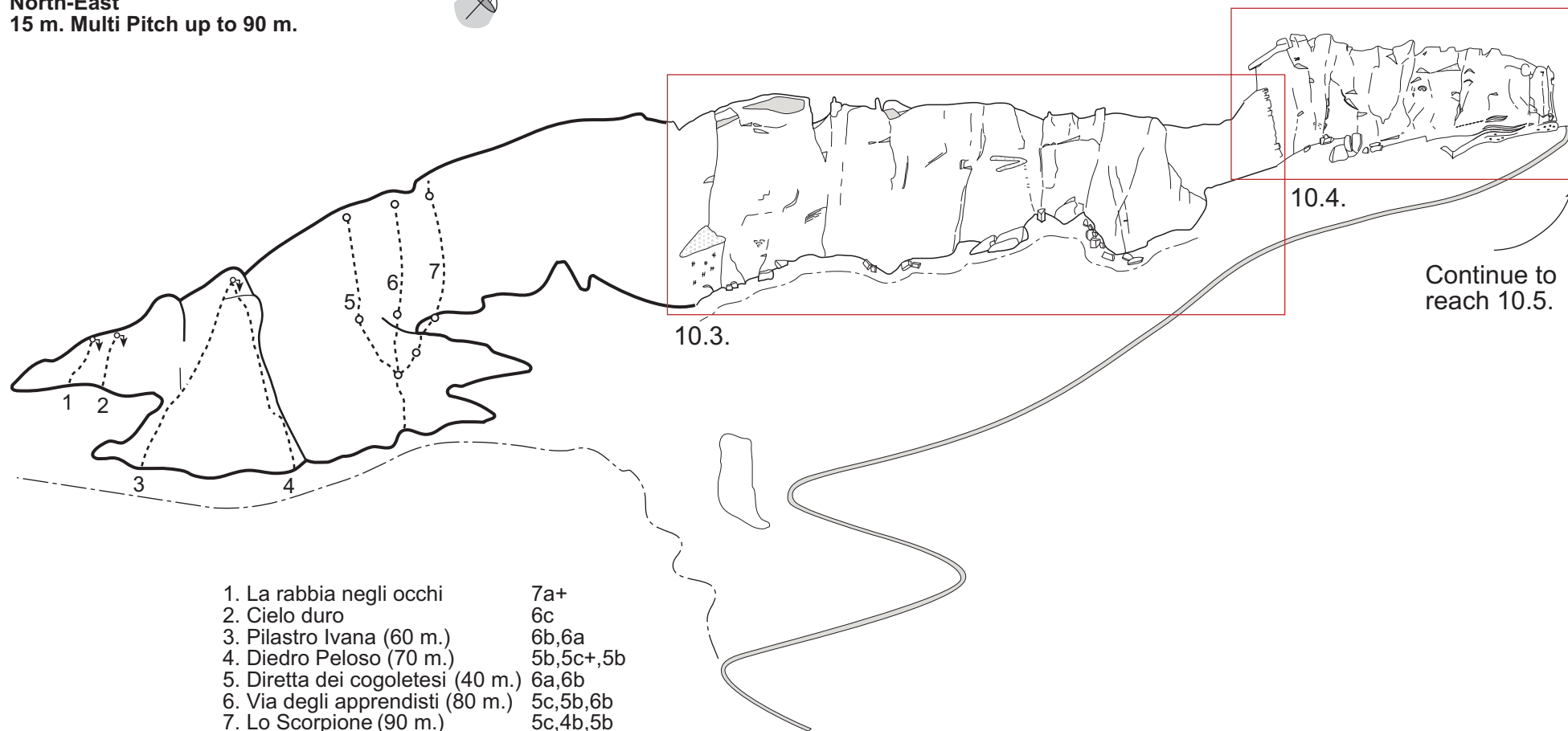

© coronn.com

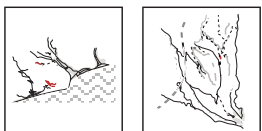

### 10.3. Bric del Frate, Centrale

N 44° 12.394'  
EO 08° 19.064'

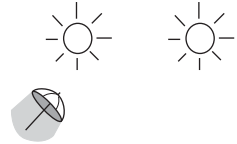

North, North-East  
30 m. Multi Pitch up to 80 m.

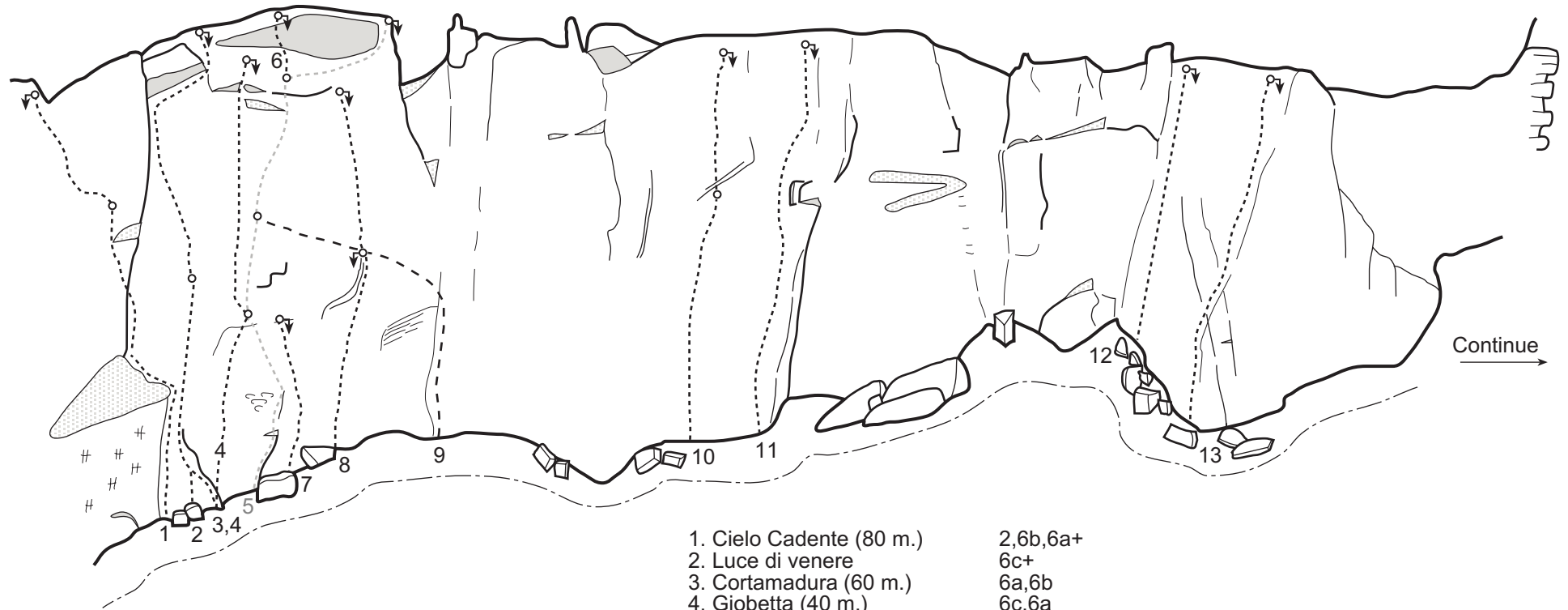

- |   |          |
|---|----------|
| 1. Cielo Cadente (80 m.)                | 2,6b,6a+ |
| 2. Luce di venere                       | 6c+      |
| 3. Cortamadura (60 m.)                  | 6a,6b    |
| 4. Giobetta (40 m.)                     | 6c,6a    |
| 5. Francesca (70 m.)                    | 4c,6a,5c |
| 6. Un Anno fa                           | 7a       |
| 7. Sto acciso che guai                  | 6b       |
| 8. Maestri di sogni impossibili (50 m.) | 6b+,6c+  |
| 9. Khomeini                             | 6a       |
| 10. Apollo                              | 6c       |
| 11. Moonlight drive                     | 6a+      |
| 12. Eisloch                             | 6a       |
| 13. Windjammer                          | 6b       |

© coronn.com

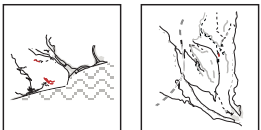

# 10.4. Bric del Frate, Settore Destro Nord

North, North-East  
25 m.

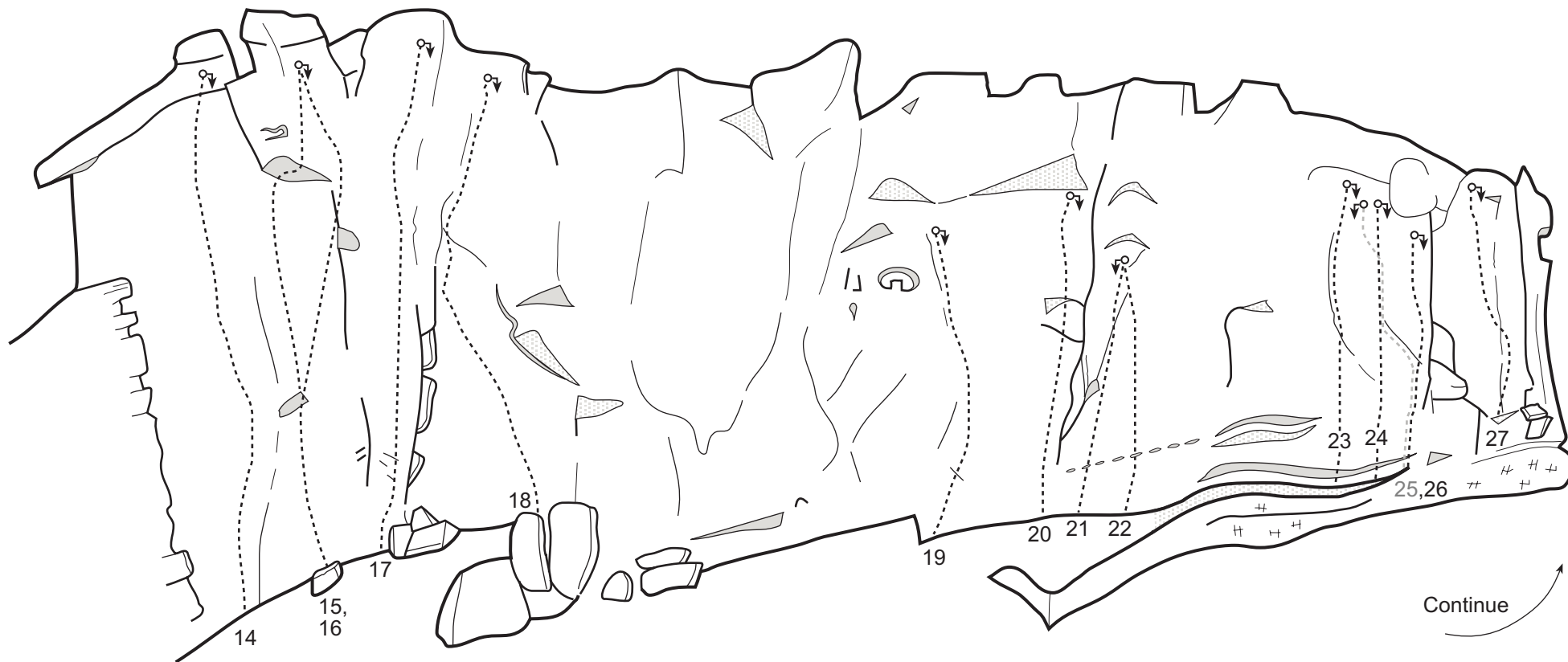
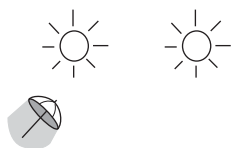

Continue

- |                       |     |                               |     |
|-----------------------|-----|-------------------------------|-----|
| 14. Piccola gemma     | 6b+ | 21. Stocastic emotion         | 6a  |
| 15. Impeto e assalto  | 7a  | 22. Variante Caotica          | 6a  |
| 16. Vita veloce       | 6b+ | 23. Komm mit                  | 7a  |
| 17. Ideal standard    | 6a+ | 24. Kurzer moment             | 7a+ |
| 18. Le spine          | 6a  | 25. Momenti perduti nel tempo | 7a  |
| 19. Via a Cordini     | ?   | 26. Peperon sublime           | 6a+ |
| 20. Maturi e contenti | 5c  | 27. Im eiltempo               | 6b  |

© coronn.com

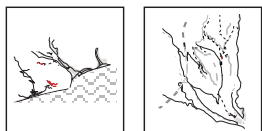

# 10.5. Bric del Frate, Settore Destro Ovest

N 44° 12.415'  
EO 08° 18.998'

West, North-West  
25 m.

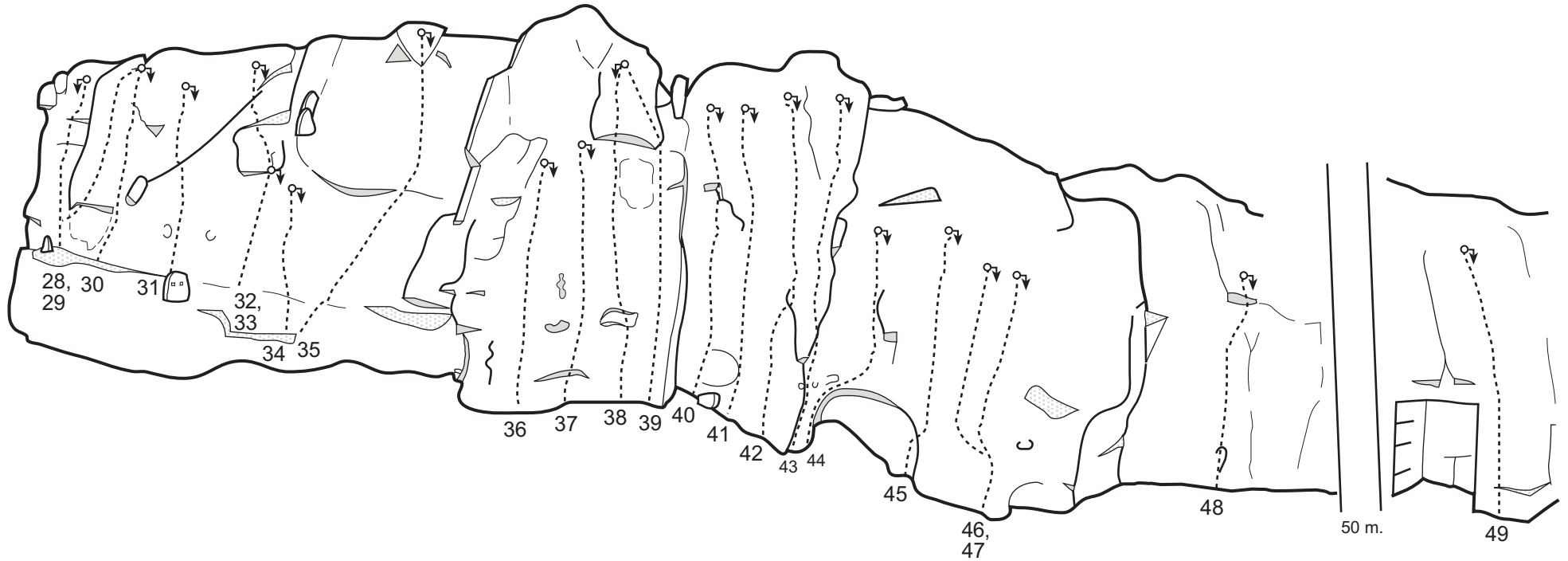
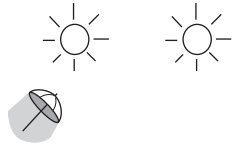

- |                           |     |                                      |     |
|---------------------------|-----|--------------------------------------|-----|
| 28. Turbo lenta           | 6b  | 39. ?                                | 6a  |
| 29. No pint hope          | 5c  | 40. Virus                            | 7a+ |
| 30. Easy livin            | 6b  | 41. Einsturzende neubauten           | 7a  |
| 31. ?                     | 5c  | 42. Cacao meravigliao                | 6b  |
| 32. Finale on the rocks   | 6b  | 43. Es geht los                      | 6a+ |
| 33. Streetfighter         | 6b  | 44. Indietro tutta                   | 6b  |
| 34. Ansioline e salviette | 6a+ | 45. Macla                            | 6b+ |
| 35. Pippo fa la Pizza     | 6c  | 46. Io chiodo, tu scali, Lui degrada | 6a  |
| 36. Patchwork             | 5c  | 47. Miss K la PP                     | 5c  |
| 37. Tra una e l'Altra     | 6b  | 48. Voglia gialla                    | 6b+ |
| 38. Aladino               | 6b+ | 49. Steingarten                      | 6c+ |

About 250 m. to crag no. 9, Pian Marino

© coronn.com

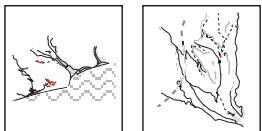

## 11.0. Valle Aquila, Keymap

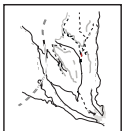
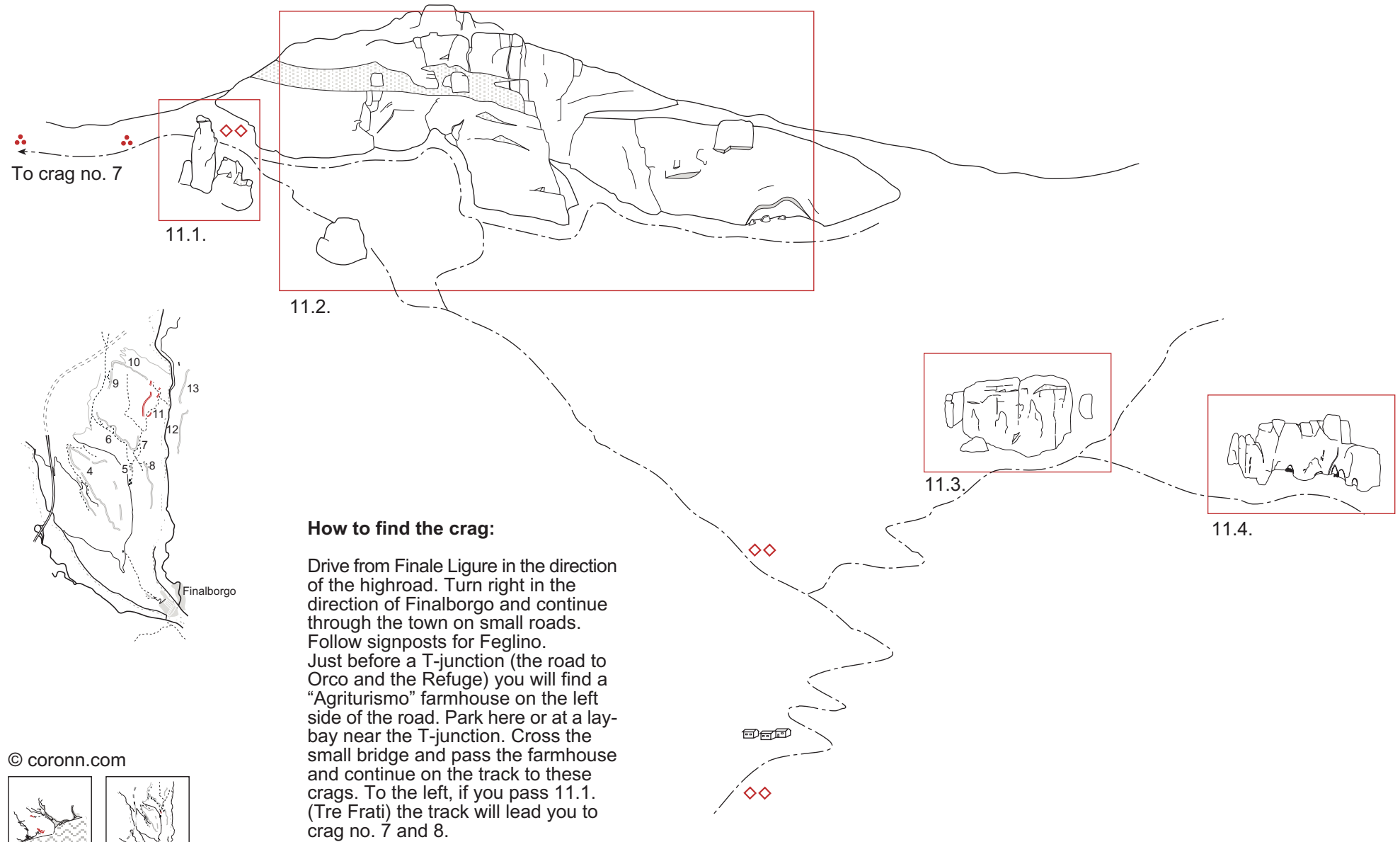

# 11.1. Tre frati

East  
20 m.

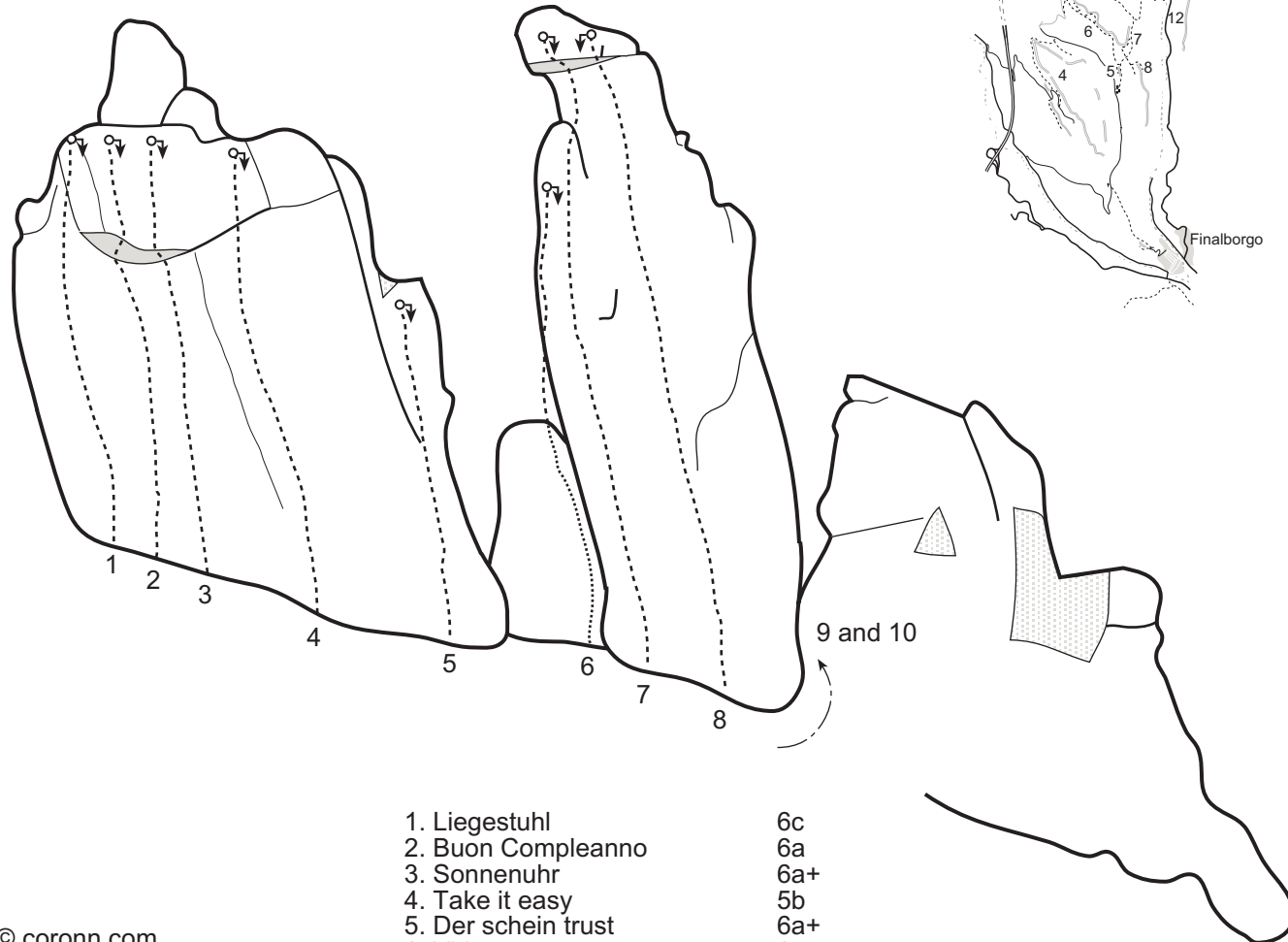
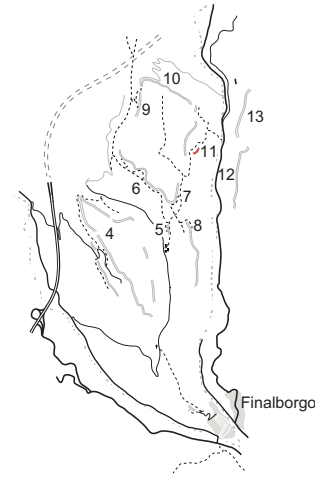
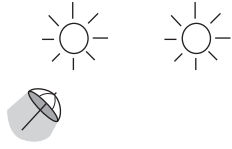

- |                     |     |
|---------------------|-----|
| 1. Liegestuhl       | 6c  |
| 2. Buon Compleanno  | 6a  |
| 3. Sonnenuhr        | 6a+ |
| 4. Take it easy     | 5b  |
| 5. Der schein trust | 6a+ |
| 6. Video            | 6c  |
| 7. Dito nel Sonno   | 6b  |
| 8. Mittelnahrt      | 6a  |
| 9. Normale          | 5c  |
| 10. Starlight       | 6c  |

© coronn.com

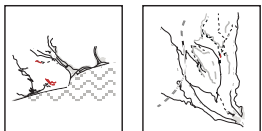

# 11.2. Bric Grigip

East  
30 m. Multi Pitch up to 80 m.

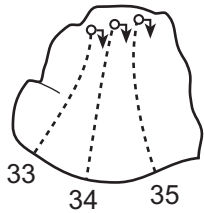
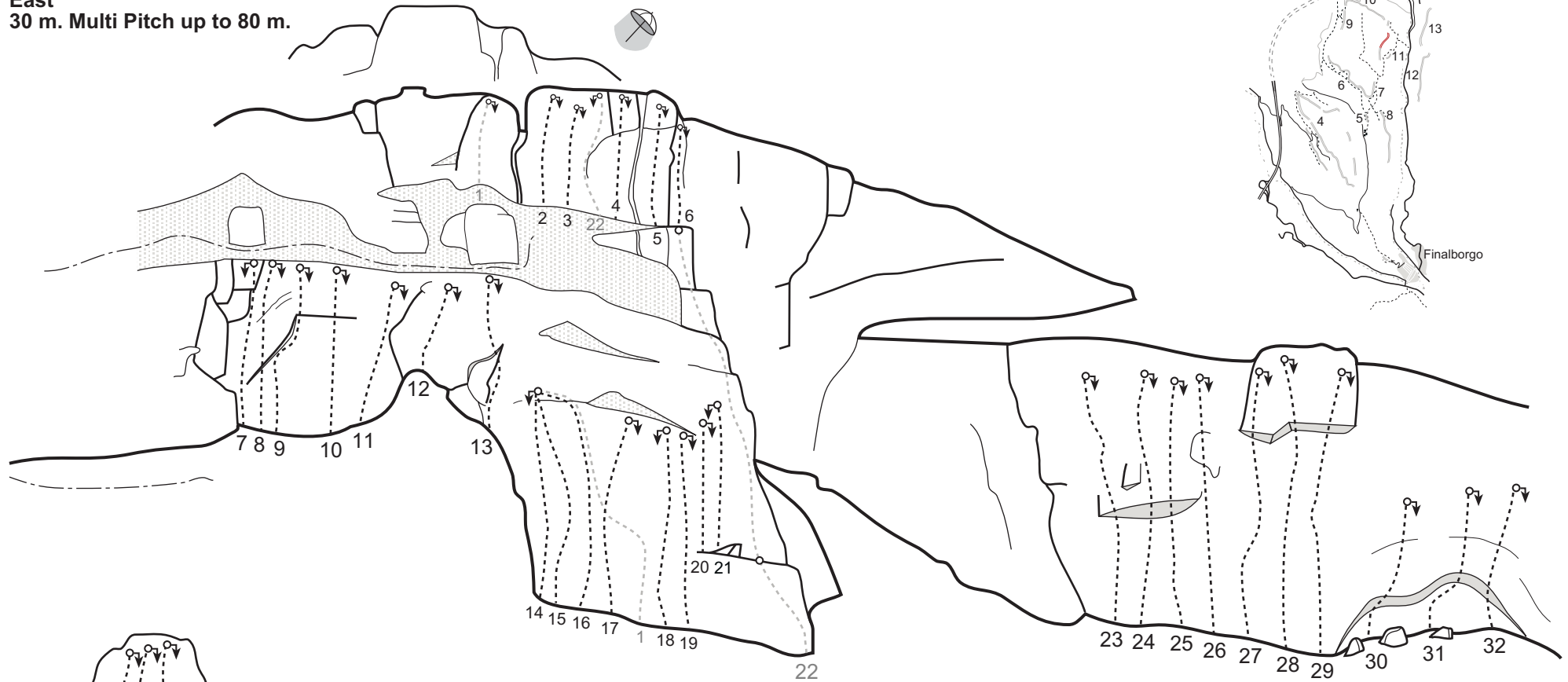
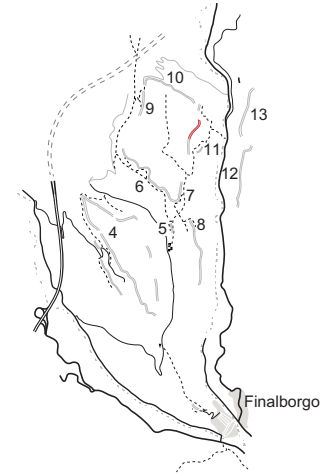
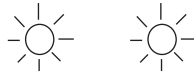

© coronn.com

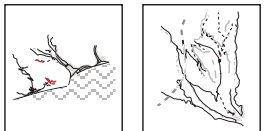

- |                                  |        |                                       |     |                                 |       |
|----------------------------------|--------|---------------------------------------|-----|---------------------------------|-------|
| 1. Spit fobia                    | 6b+,6b | 13. ?                                 | 6a  | 25. Bulla                       | 6b    |
| 2. La Luna                       | 6b     | 14. Play dance                        | 7a  | 26. Bolla                       | 6c    |
| 3. Esatto                        | 7a     | 15. I dubbi dello schiavo del tempo   | 6c  | 27. La Babbiona                 | 7b    |
| 4. E' qui la festa               | 5b     | 16. Tempi supplementari               | 6c  | 28. Apollo                      | 6c    |
| 5. C'e' da spostare una macchina | 7b     | 17. Fiaba d'Autunno                   | 6b+ | 29. Apelle                      | 7a    |
| 6. Bongo                         | 7a     | 18. Appuntamento con venere           | 7a  | 30. L'Occasione fa l'Uomo Ragno | 7a,7a |
| 7. ?                             | 5c     | 19. La cimice in mutande              | 7a  | 31. Palla                       | 7b    |
| 8. ?                             | 5c     | 20. S'Allonger                        | 6c  | 32. Pollo                       | ?     |
| 9. ?                             | 6a+    | 21. Le paure di un videocitfono       | 7b  | 33. ?                           | 6a+   |
| 10. ?                            | 6a+    | 22. Sperone del cinquantenario (80m.) | 5c  | 34. ?                           | 7b    |
| 11. ?                            | 6a     | 23. Balla                             | 6c  | 35. Belgarath                   | 8b    |
| 12. ?                            | 5c     | 24. Bella                             | 6b+ |                                 |       |

### 11.3. Kattedrale

East  
25 m.

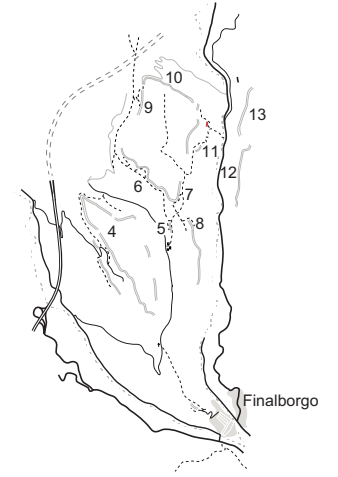
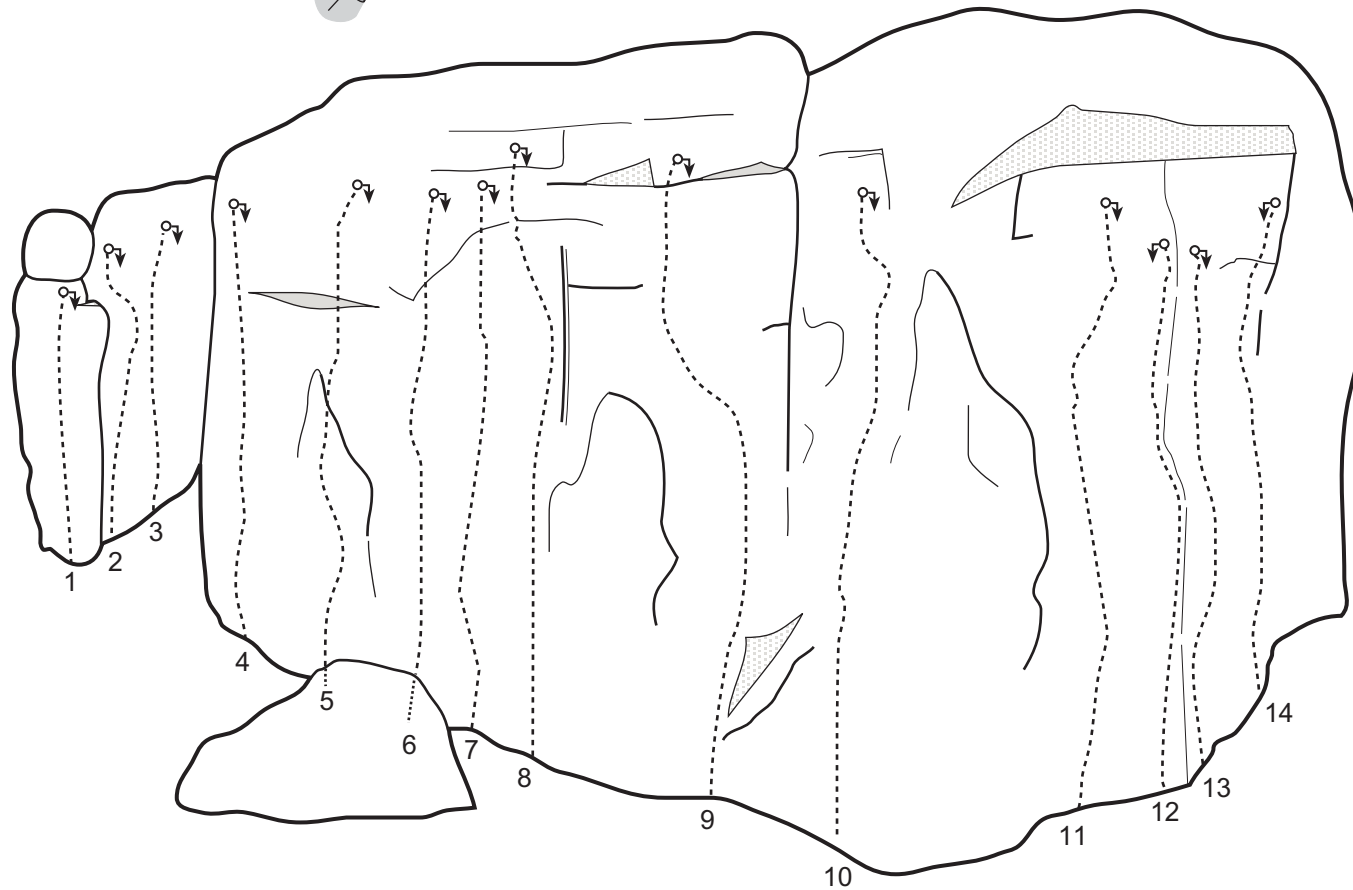

- |                                 |     |
|---------------------------------|-----|
| 1. Colpo di testa               | 7b  |
| 2. Grazia                       | 6b  |
| 3. Black love                   | 6b+ |
| 4. La contessa                  | 7a  |
| 5. Fragile                      | 6c  |
| 6. C'Est la ouate               | 7a+ |
| 7. Splendida                    | 7a  |
| 8. Disidratazione               | 7b  |
| 9. Alienazioni mentali          | 7b  |
| 10. Per aspera ad Astra         | 7a  |
| 11. La Cavalcata delle Walkirie | 7a  |
| 12. Diedro incompreso           | 6a  |
| 13. Samarcanda                  | 6c+ |
| 14. Mater tenebrarum            | 6b+ |
| 15. Baby Killer                 | 6b+ |

© coronn.com

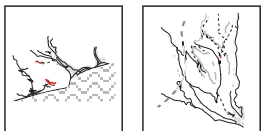



# 11.4. Sakrestia

East  
15 m.

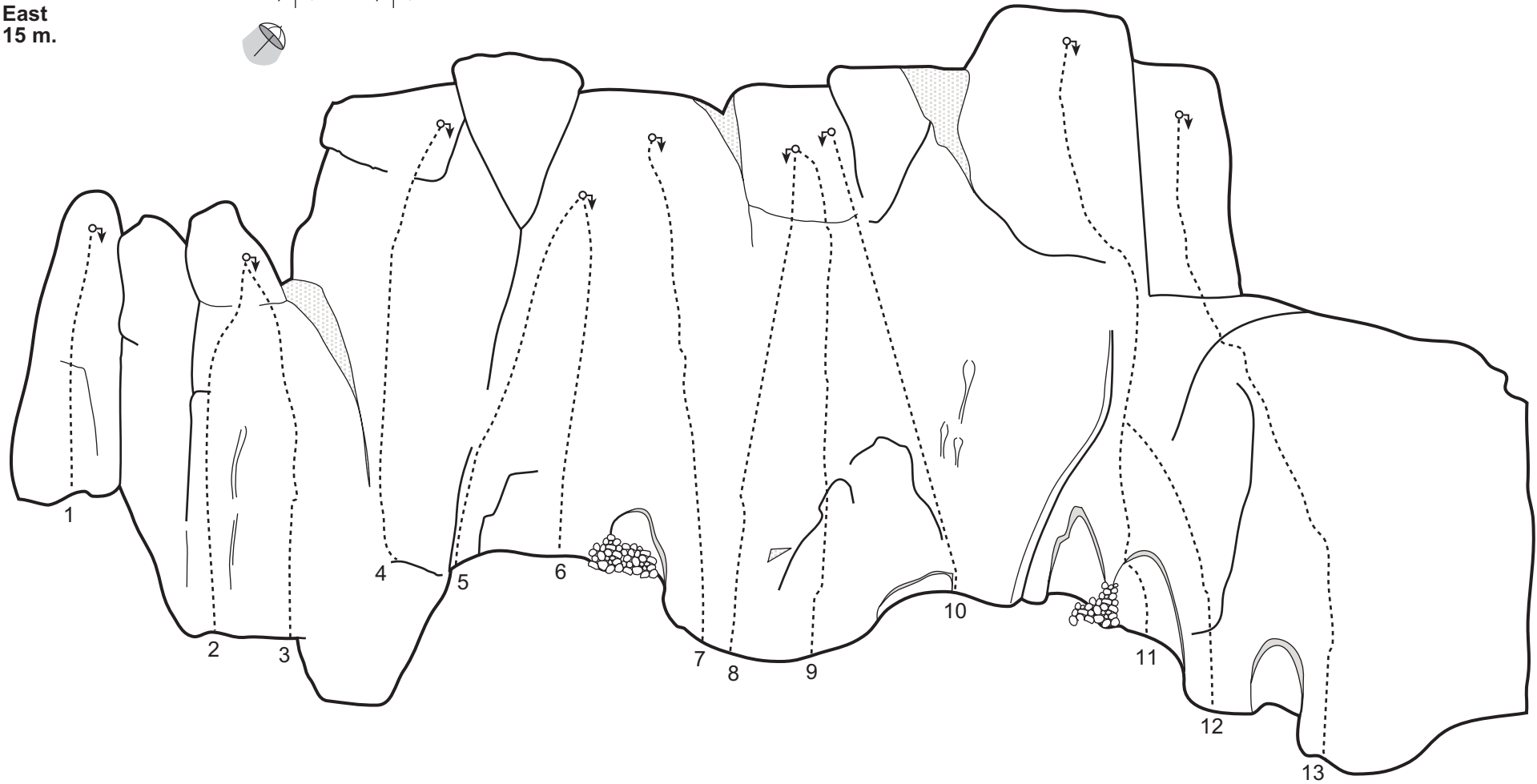
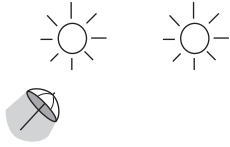

© coronn.com

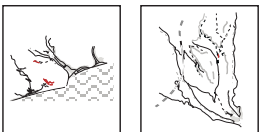

- 1. Vita impossibile
- 2. Espiazione
- 3. Gita al Lago
- 4. Dolce torpore
- 5. Chi non muore si rivede
- 6. Piccolo `Ea`
- 7. L'Uomo pesante

- 6a
- 7b
- 6c
- 6c+
- 6a
- 6c
- 6c+
- 8. Vamos al Pepita
- 9. Lo Sfratto
- 10. Cece
- 11. Mamy Puo' Salire
- 12. Anche dodo
- 13. ?

- 6b
- 6a+
- 6a+
- 6a
- 6b
- 6a+

## 12.0. Valle Aquila(East side) and 13.0. Bric Spaventaggi, Keymap

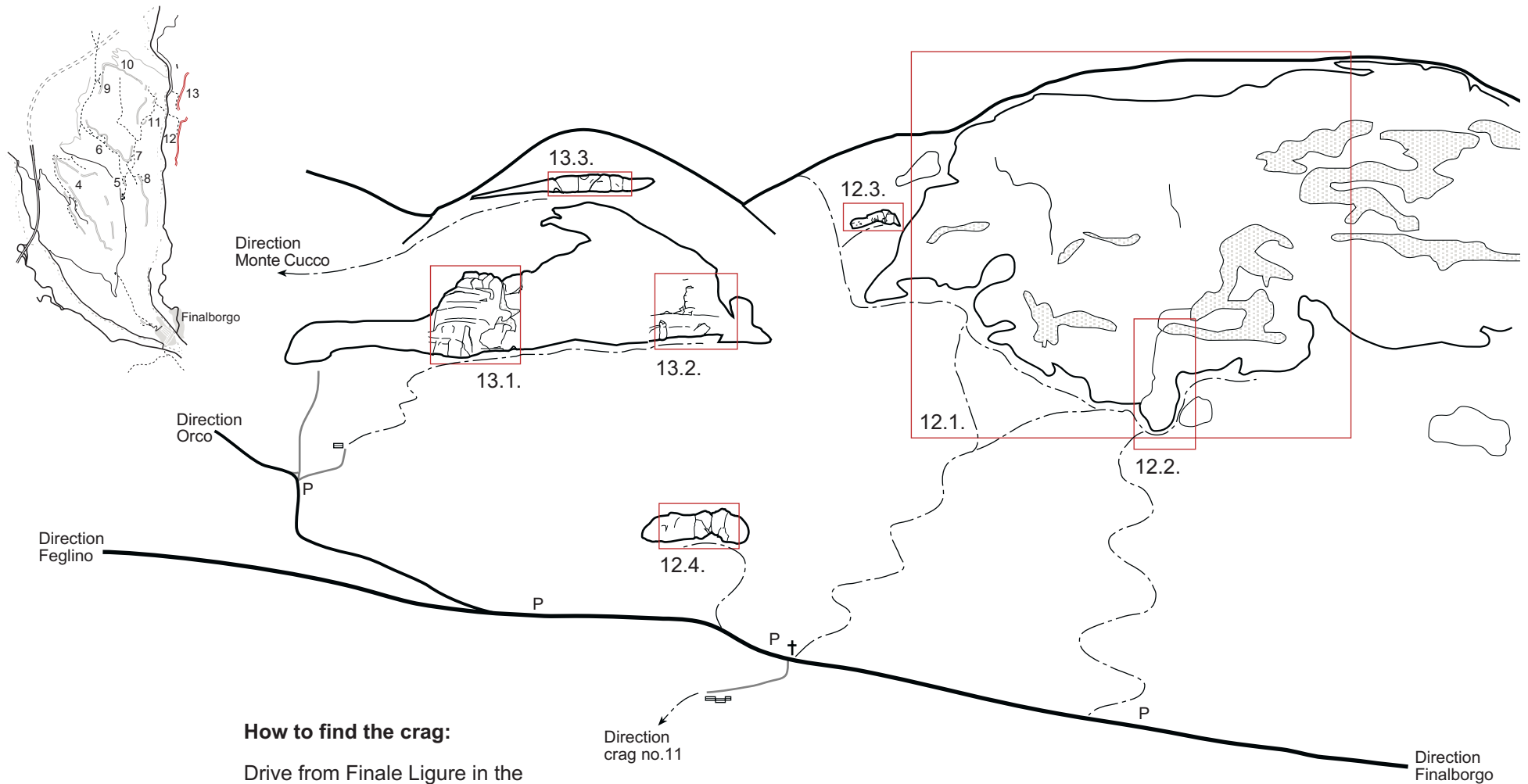

### How to find the crag:

Drive from Finale Ligure in the direction of the highroad. Turn right in the direction of Finalborgo and continue through the town on small roads. Follow signposts for Feglino. Just before a T-junction (the road to Orco and the Refuge) you will find a "Agriturismo" farm house on the left side of the road. Park here and follow the track to reach the crags 12.1. to 12.3. To reach 12.4., continue in the direction of Feglino and turn right on to a track after about 50 m.

To reach crag no. 13; Turn right in the T-junction in the direction of Orco. The road turns right and in the next bend to the left you will see a stone-quarry. Park here and follow the road that leads up to a "Agriturismo" (tourist farmhouse). Continue on the tracks to the crag. To reach 13.3. continue from the last sector of Monte Cucco (30-40 minutes).

© coronn.com

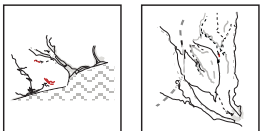

# 12.1. Bric Pianarella

West  
20 m. Multi Pitch up to 250 m.

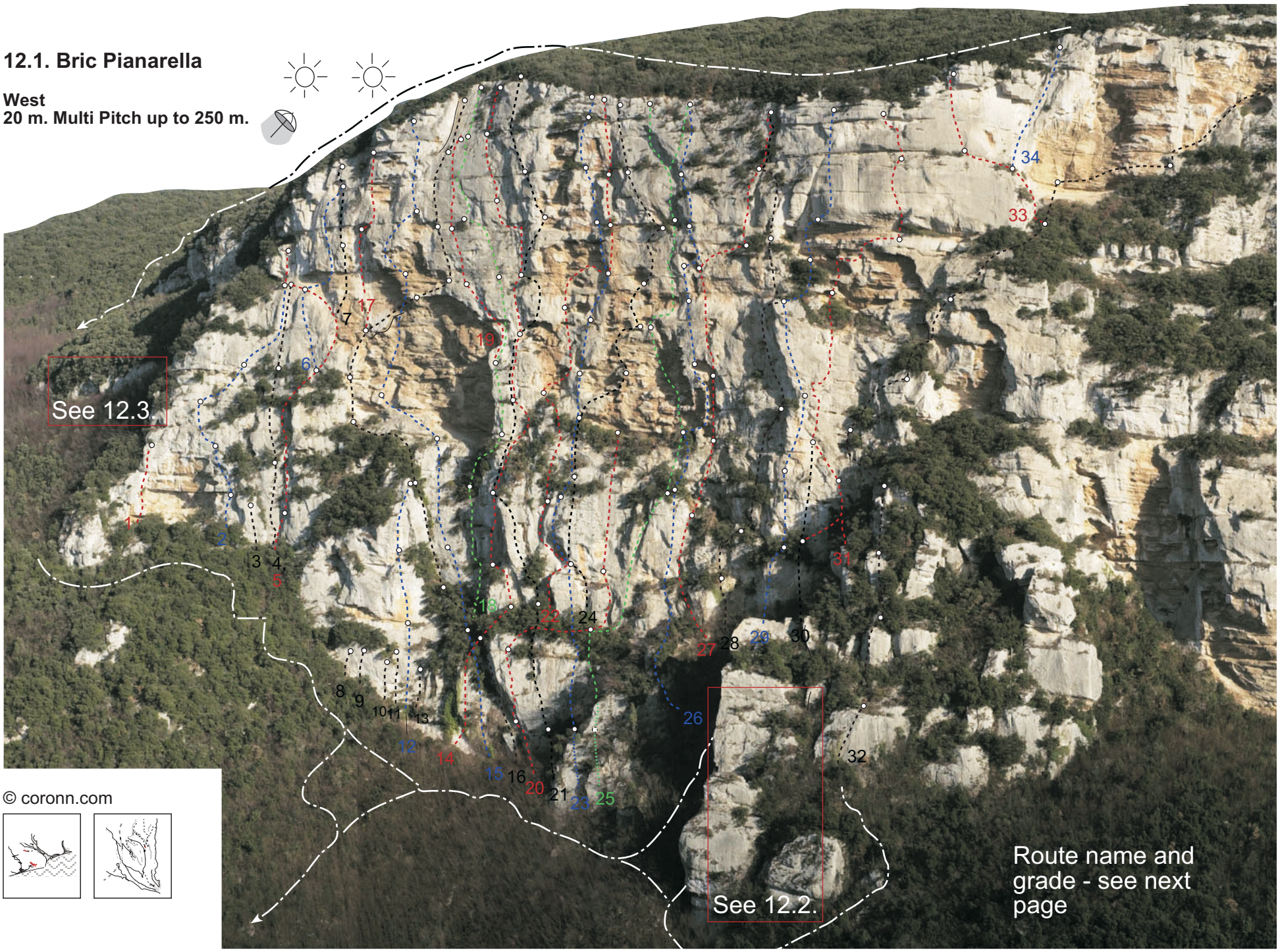
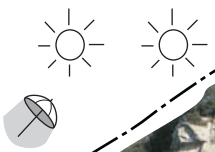

See 12.3.

See 12.2.

Route name and grade - see next page

© coronn.com

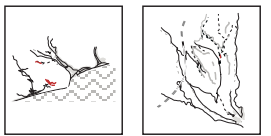

## 12.2. I Missili

North  
25 m.



- |  |  |
|--|--|
| 1. Tetto building                      | 6b+  |
| 2. L'Autunno dei Moicani (150 m.)      | 5c,6a,5b,4c,5b,5b                            |
| 3. Big foot                            | 6a+  |
| 4. Antro vergognoso (80 m.)            | 6a+,6b,7a                                    |
| 5. Fivy (120 m.)                       | 5c,6a+,4+,6a,5b                              |
| 6. L'Incertezza (60 m.)                | 6c+,7b,6a+                                   |
| 7. Amico con L'Ombrello (80 m.)        | 5b,6b,6a+                                    |
| 8. Ditelo con i flap                   | 6b+  |
| 9. Margherita                          | 6b+  |
| 10. Follie Notturne                    | 6b+  |
| 11. Il Triangolo                       | 6a   |
| 12. Slash (80 m.)                      | 6b+,6b,6c                                    |
| 13. Gli Svenimenti di squappa          | 6b+  |
| 14. Vaccari (240 m.)                   | 3c,5b,3b,5b,?,5b,6b,<br>6a, 6a+,4,5b,4b      |
| 15. Menti perdute (210 m.)             | 5b,6b+,6a+,5a,6a+,<br>6c,6a,6c               |
| 16. Catarifrangente (200 m.)           | 5b,5b, 5b, 6b,5c,5c,<br>6c,6c,6c+            |
| 17. Pantera Rosa (80 m.)               | 6c,5c  |
| 18. Gianni Pajer (250 m.)              | 6a,5c,5c,5b,7b,6a,6b,4+                      |
| 19. Non ci resta che piangere (100 m.) | 6b,7a+,6c                                    |
| 20. @ (at) (100 m.)                    | 7b   |
| 21. Joe Falchetto (240 m.)             | 6c,6a,6c,6a,7a,6a+,<br>7a,5c                 |
| 22. Calcagni (240 m.)                  | 3b,5c,6a,6c,5c,6a,5b,5b                      |
| 23. Mio Nome (240 m.)                  | 6c/A2  |
| 24. Impedimento sterico (240 m.)       | 3c,5c/A0,5c/A0,5/A0,<br>5/A0,5/A1,6a/A1,5c,? |
| 25. Grimonett (240 m.)                 | 5c,5b,5b,5c,5+,6b,6b                         |
| 26. Gni (200 m.)                       | 5c,6c,4c,5b,6c+,6a+,<br>6c+,6b+,5b           |

© coronn.com

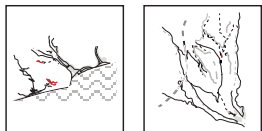

- |                             |     |
|-----------------------------|-----|
| 35. ?                       | ?   |
| 36. Non pensarci due volte  | 8b  |
| 37. Senza chiedere permesso | 8c  |
| 38. Universo proibito       | 8a  |
| 39. Evocazioni              | 6c+ |

- |   |                                     |
|---|-------------------------------------|
| 27. I.N.P.S. (200 m.)                           | 4c,6b,5a,5c,6a,6a+,<br>6a,6a,5      |
| 28. Amicizia (200 m.)                           | 6c,6a+,4c,5b,6a,5b,<br>6b+,5b       |
| 29. Tempio della Gioventu'<br>Psichica (180 m.) | 6b,7a,6c,7a,6b+,6c+,6b+             |
| 30. ?   | ?                                   |
| 31. Paperino (180 m.)                           | 6a,6a+,6a+,6a+,4c,6a+,<br>5c/A1,6a+ |
| 32. Via lunga (240 m.)                          | 3c,4b,5b,4c,4c,3b,4a,5b             |
| 33. Variante di sinistra                        | 6a+,6a                              |
| 34. Variante di destra                          | 6a                                  |

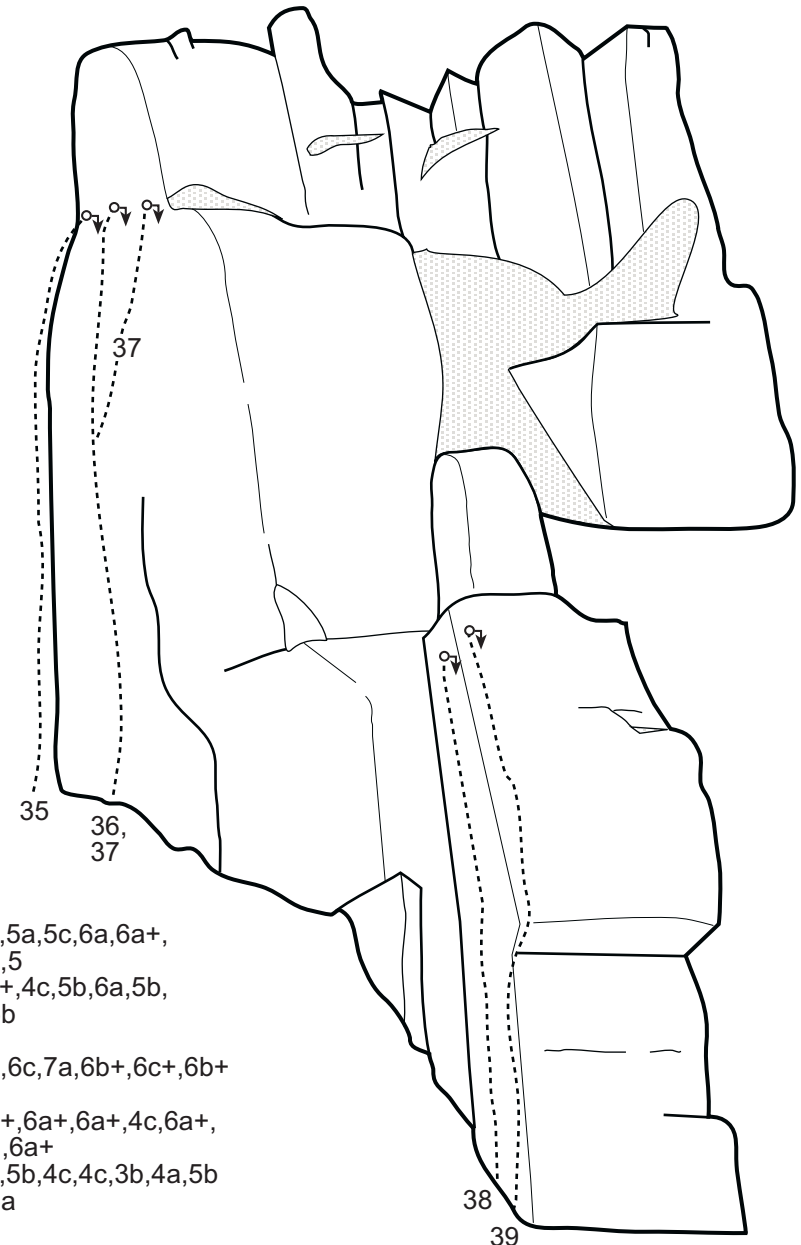

## 12.3. La Mansarda and 12.4. Il Sasso

North  
25 m.

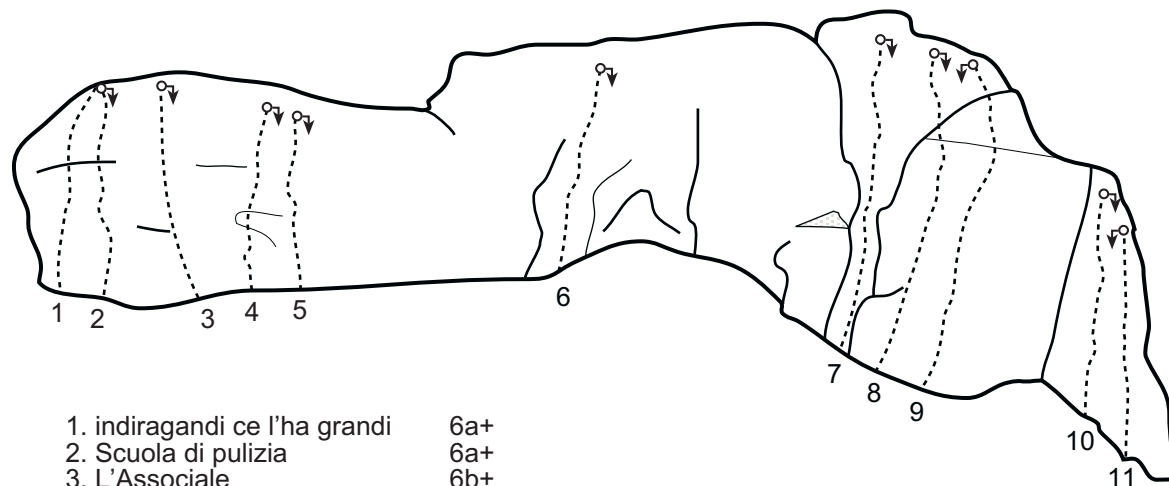
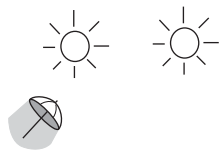

- |                                      |     |
|--------------------------------------|-----|
| 1. indragandi ce l'ha grandi         | 6a+ |
| 2. Scuola di pulizia                 | 6a+ |
| 3. L'Associare                       | 6b+ |
| 4. Ghiri moderni                     | 6b+ |
| 5. Osteria del Pirata                | 6b  |
| 6. Realta' Colorata                  | 6c+ |
| 7. Dissoluzione Psicica              | 7b  |
| 8. Nevrotica                         | 7b+ |
| 9. Psycho                            | 8a  |
| 10. ...e le stelle stanno a guardare | 7a+ |
| 11. Occhi                            | 7a  |
| 11. (direct)                         | 7b  |

- |                             |     |
|-----------------------------|-----|
| 1. ilguana                  | 6c  |
| 2. Zamba pa Ti              | 7a  |
| 3. Scaramouche              | 7b  |
| 4. La volpe Azzurra         | 7b+ |
| 5. La pietra dello scandalo | 7c+ |
| 6. Lavori in corso          | 7a+ |

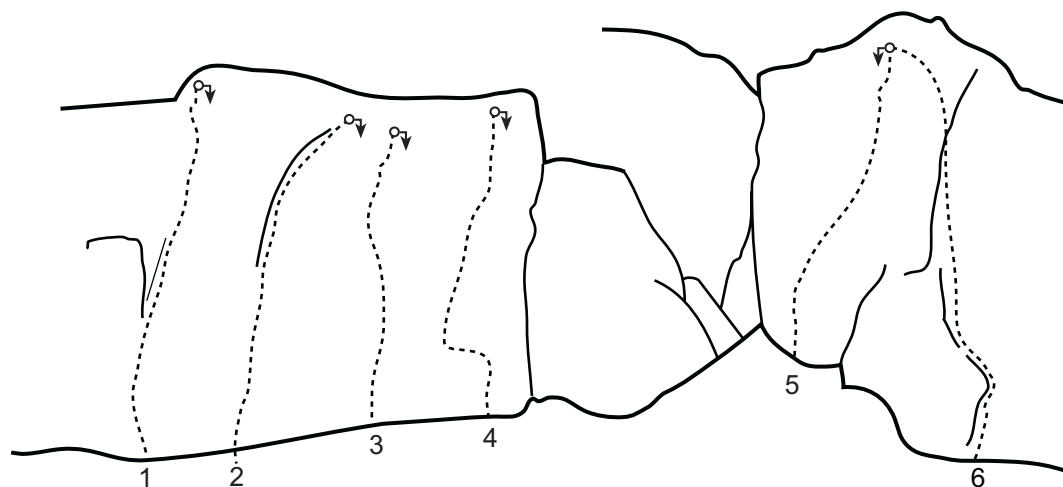

© coronn.com

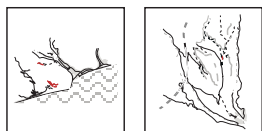

# 13.1. Bric Spaventaggi, Superpanza

West  
40 m. Multi Pitch up to 150 m.

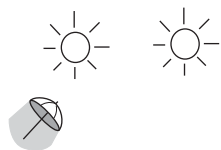

- |  |                |
|--|----------------|
| 1. Steady state (75 m.)                | 6a,6c,6a+,7a   |
| 2. Superplacca (75 m.)                 | 6b,7a,6b+,7c+  |
| 3. Paprica                             | 7c             |
| 4. Cloto (80 m.)                       | 6c+,6b+,7a     |
| 5. Superpanza (100 m.)                 | 4b,6b+,5,6a+   |
| 6. Vuoto a perdere (90 m.)             | 5c,6c+,6c,6b   |
| 7. Tip Tap per Giovanna                | 6a+            |
| 8. Legati per la vita                  | 5c             |
| 9. ?                                   | 6a+            |
| 10. ?                                  | 7a+            |
| 11. baobab pret a Porter               | 7b+            |
| 12. Foca Ridens                        | 6b+            |
| 13. ?                                  | 6b             |
| 14. ?                                  | 5c             |
| 15. Asterix (40 m.)                    | 6a,6a          |
| 16. Libera Nos (100 m.)                | 5c,5b,5b,5b,5  |
| 17. Crucefix (70 m.)                   | 5c,5c,6b       |
| 18. Placca di Shan-Gri-La              | 6b+            |
| 19. Placca di Shan-Gri-La              | 5c,5c,6a+      |
| 20. Paola, Daniela e le altre (150 m.) | 5b,5b,6a,5b,5c |

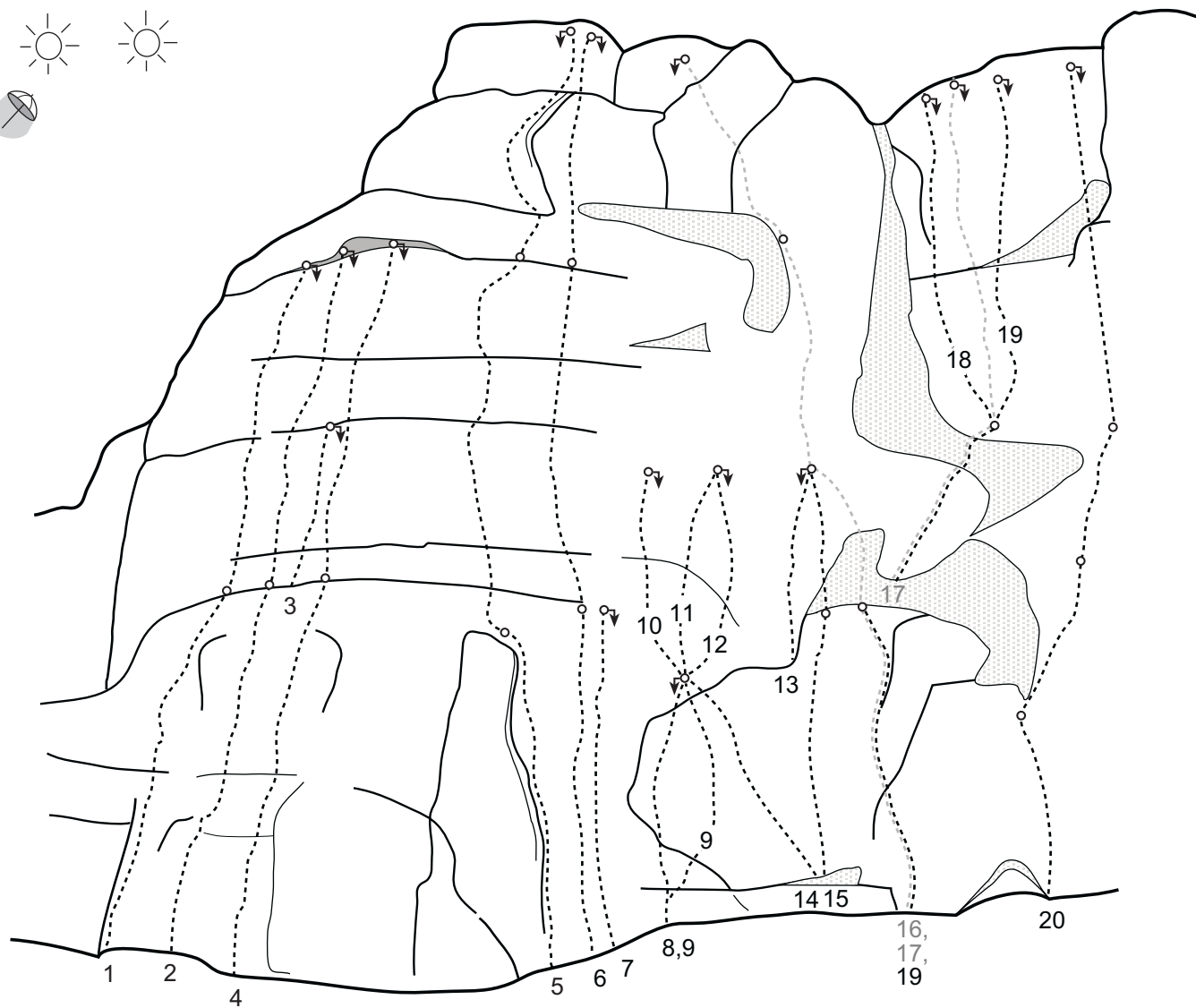

© coronn.com

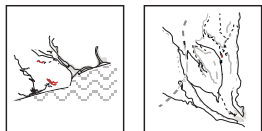

## 13.2. Bric Spaventaggi, Placca dei Maleducati

West  
25 m. Multi Pitch 110 m.

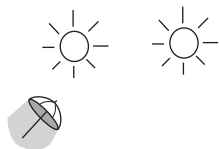

1. Edith
2. Pippi
3. Il falchetto picchietto e il mangiatore di mosche
4. Deciso e preciso
5. Cocoon
6. Maga Magu'
7. Apile dolce dormire
8. Materia grigia
9. Fuga di 1/2 giorno
10. Il Gatto e la Volpe
11. Portaci a Berna
12. ?
13. Grazie lo stesso
14. Mylu'
15. Jazz Blues fusion
16. Ra Perbureira

- 6b
- 6a+
- 3b,6a,3b,4a
- 6b+
- 6b+
- 6b
- 5c
- 6a+
- 6a
- 6a+
- 6c
- 5,6a
- 6a
- 7a
- 6b
- 6b+

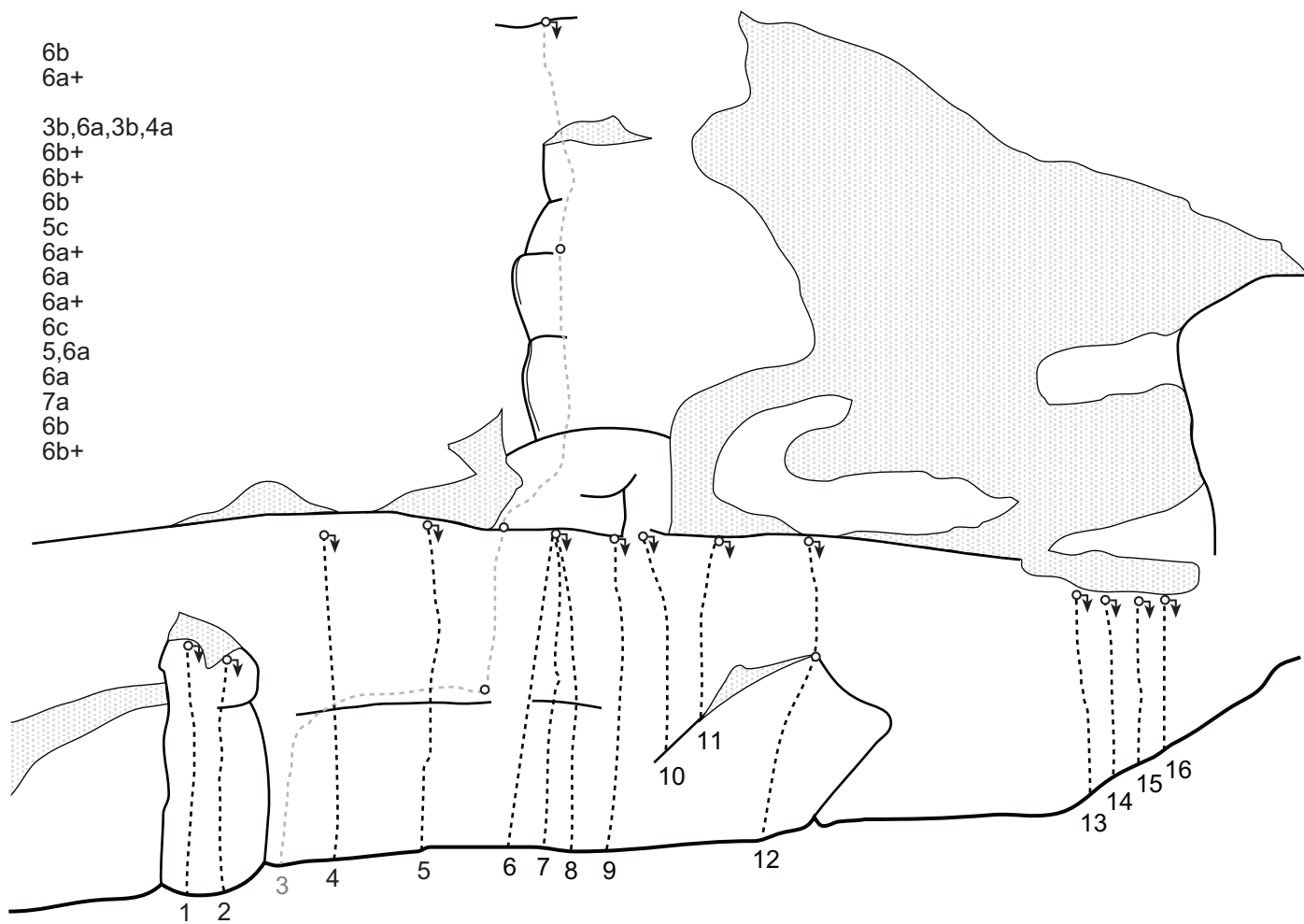

© coronn.com

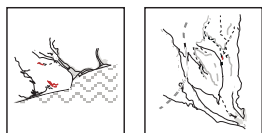

### 13.3. Bric Spaventaggi, Attico

West  
15 m.

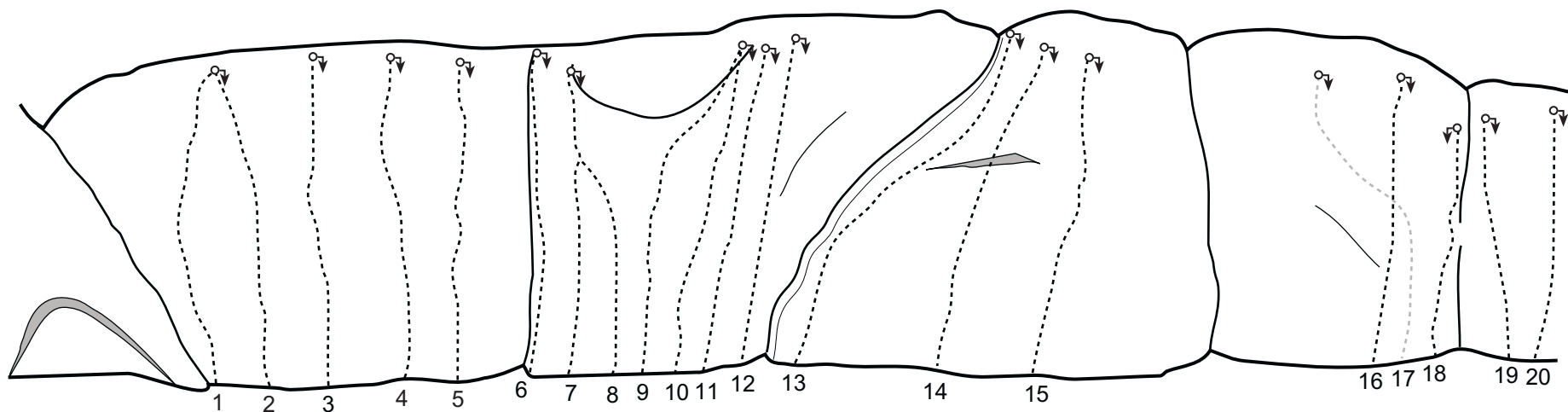
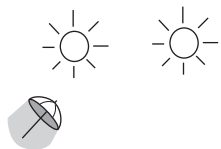

- |                                |     |                          |     |
|--------------------------------|-----|--------------------------|-----|
| 1. Bazar dei sogni             | 7a  | 11. Vagabondo            | 6c+ |
| 2. L'Ultima Luna d'Autunno     | 7b  | 12. Non Arrenderti       | 5b  |
| 3. Il tradimento di Gobetti    | 4c  | 13. Khumjung             | 5c  |
| 4. Nel cofano... e per sempre  | 6a  | 14. Il respiro del tempo | 7a  |
| 5. Salto nel tempo             | 6b  | 15. Thai                 | 6a+ |
| 6. Solitudine                  | 6a  | 16. Piantala Kuty        | 6a  |
| 7. Ponti di Bactabul/Fumo nero | 7a  | 17. La Cosa              | 6a  |
| 8. Cannelure                   | 6b+ | 18. Attrazione fatale    | 6b  |
| 10. Ponti sull'Infinito        | 6c  | 19. Sveltina             | 6b+ |
|                                |     | 20. ?                    | 5c  |

© coronn.com

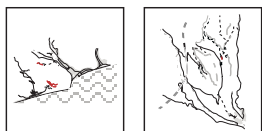



## 14.0. Monte Cucco, Key-map

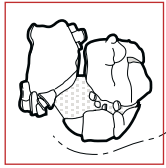
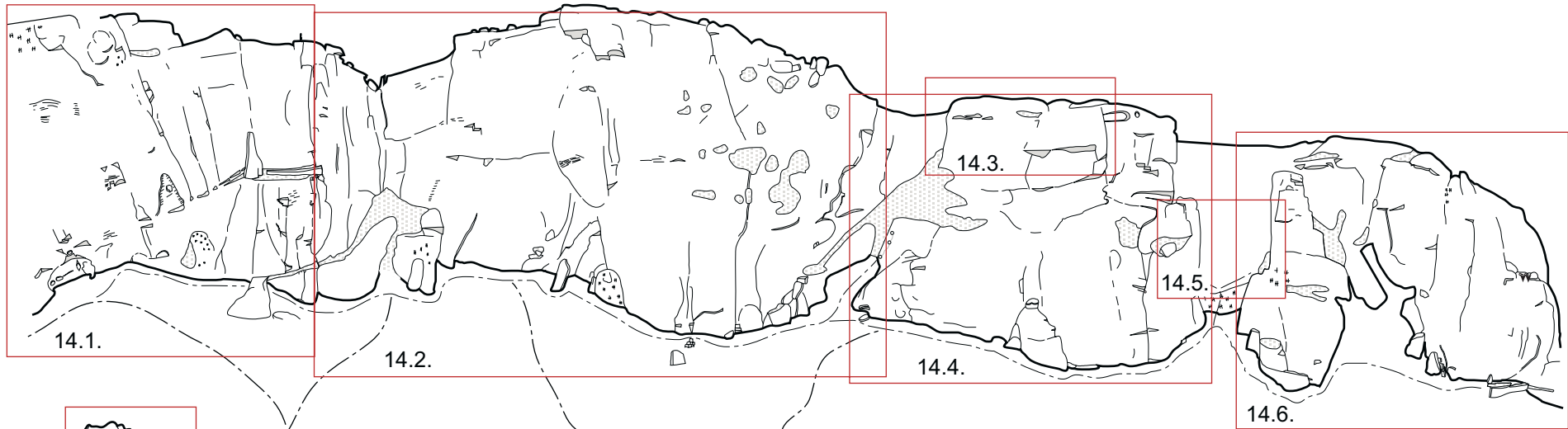

Direction  
Orco

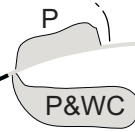

### How to find the crag:

Drive from Finale Ligure in the direction of the highroad. Turn right in the direction of Finalborgo and continue through the town on small roads. Follow signposts for Feglino. In a T-junction, turn right in the direction of Orco. Before Orco you will pass a "Rifugio". Just at the opposite side of the road a small road leads up to good car parks with Toilets, shower and good tracks to the different sectors of Monte Cucco.

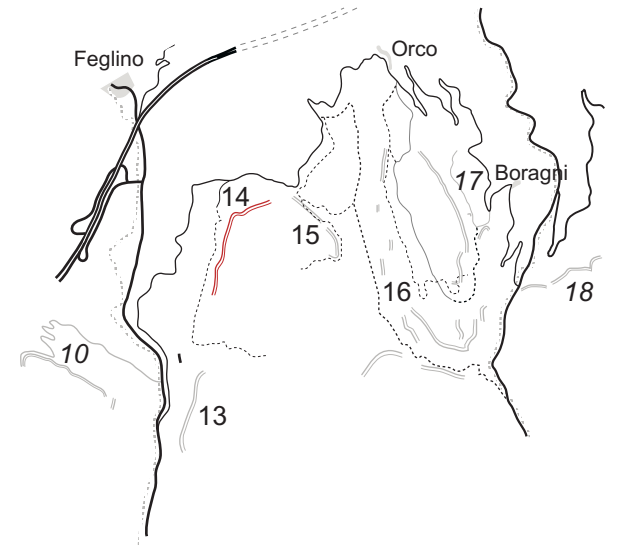

© coronn.com

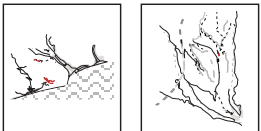

Direction  
Finale Ligure

# 14.1. Monte Cucco, Settore Orientaleo della Caverna

N 44° 12.846'  
EO 08° 19.980'

North-West  
30 m. Multi Pitch up to 100 m.

- |   |               |
|---|---------------|
| 1. Via della Caverna (100 m.)           | 4c,A2,3,5b/A1 |
| 2. ?                                    | ?             |
| 3. ?                                    | ?             |
| 4. grottendach                          | 6c+           |
| 5. Re di chia                           | ?             |
| 6. Sauta                                | 7b            |
| 7. La Modifica                          | 7a            |
| 8. Mario Valentini                      | 5c            |
| 9. ?                                    | ?             |
| 10. ?                                   | ?             |
| 11. Parigi                              | 7c            |
| 12. Vienna (50 m.)                      | 8a,8a         |
| 13. ?                                   | 6b+           |
| 14. Specchi riflessi                    | 7c+           |
| 15. Si che non sei Tu                   | 8a+           |
| 16. Lang in putrefaction (55 m.)        | 6a+,7c        |
| 17. Mentadent plus (40 m.)              | 7a,7a         |
| 18. Turisti del vuoto                   | 6b            |
| 19. Fessura dei Piacentini (needs gear) | 6a            |
| 19a. Waiting for the beer (needs gear)  | 6b            |

A small crag on the left side of the track on the way to this sector offers 3 routes;

- |                    |    |
|--------------------|----|
| Cambio d'Anni      | 6a |
| Le Ansie di Silvia | 7a |
| Newjahrsangel      | 6a |

© coronn.com

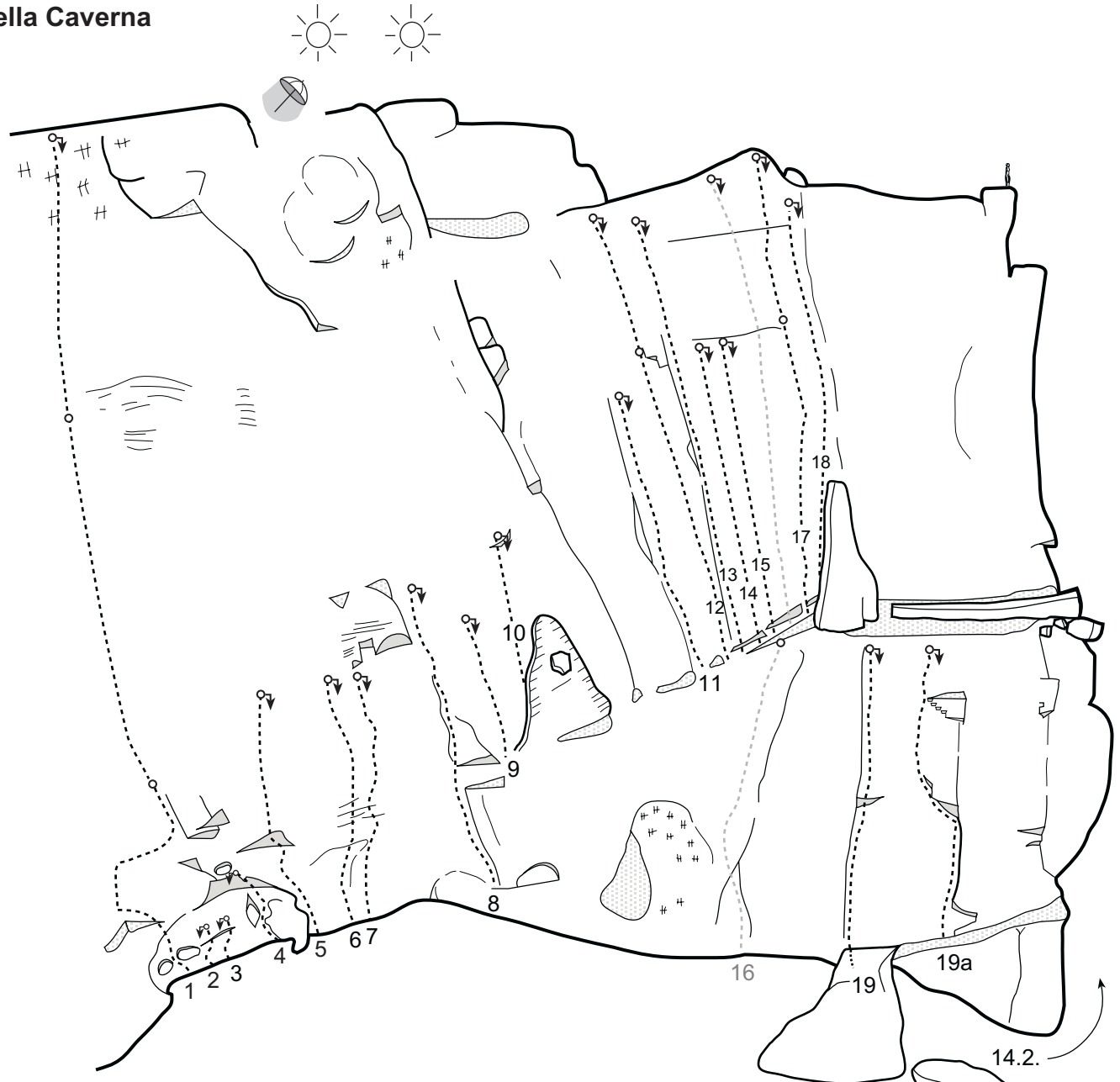
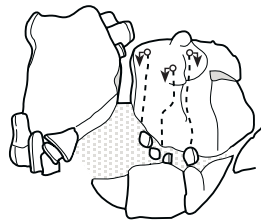
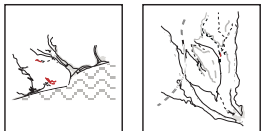

## 14.2.1. Monte Cucco, La Torre and left part of Centrale

### North-West

40 m. Multi Pitch up to 80 m.

- |                                  |            |
|----------------------------------|------------|
| 20. Quasimodo                    | 6c         |
| 21. Viulard                      | 7c+        |
| 22. Gattopardo                   | 7c+        |
| 23. Panino al Prosciutto         | 6a         |
| 24. Il Ballista                  | 6c+        |
| 25. Enrico IV                    | 6b         |
| 26. Mantra of Casualness         | 6b         |
| 27. Serenella                    | 6b         |
| 28. Folle attrazione             | 6a         |
| 29. Proiezione ascendente        | 6b+        |
| 30. Ecnaton                      | 6a+        |
| 31. La Torre (60 m.)             | 5c,5c      |
| 32. Moby Dick                    | 5c         |
| 33. Variante Che Guevara         | 5c         |
| 34. Mani d'Oro (60 m.)           | 6a,5c      |
| 35. Diedro Canale                | 3          |
| 36. Luis                         | 3c         |
| 37. Miguel (60 m.)               | 4b         |
| 38. Luc (60 m.)                  | 4          |
| 39. Banana Spit (70 m.)          | 6c+,7a,6b  |
| 40. Banana stranna               | 7c+        |
| 41. Specchio per le allodole     | 7b         |
| 42. Adele (70 m.)                | 7a,6b      |
| 43. Bull Dog                     | 6a+        |
| 44. Grillomania                  | 6a         |
| 45. Radical Chic                 | 8a         |
| 46. Moon runner                  | 7c         |
| 47. Occhio dolci per Frank Zappa | 7b         |
| 48. Diretta a Frank Zappa        | 7b+        |
| 49. È tempo di sognare           | 7a         |
| 50. Aspettando il Sole (80 m.)   | 6b,6b+,6c+ |
| 51. Per colpa di chi (60 m.)     | 6b+,6c     |
| 52. La Linea che non c'e'        | 6c+        |
| 53. Mimi e Clown (70 m.)         | 6c,6c+,6c+ |
| 54. Flash Katmandu               | 6c         |
| 55. Mimi' e coco'                | 6a         |
| 56. Variante Bassa               | 5c         |
| 57. L'Ultima avventura           | 6c         |

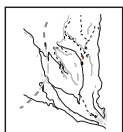
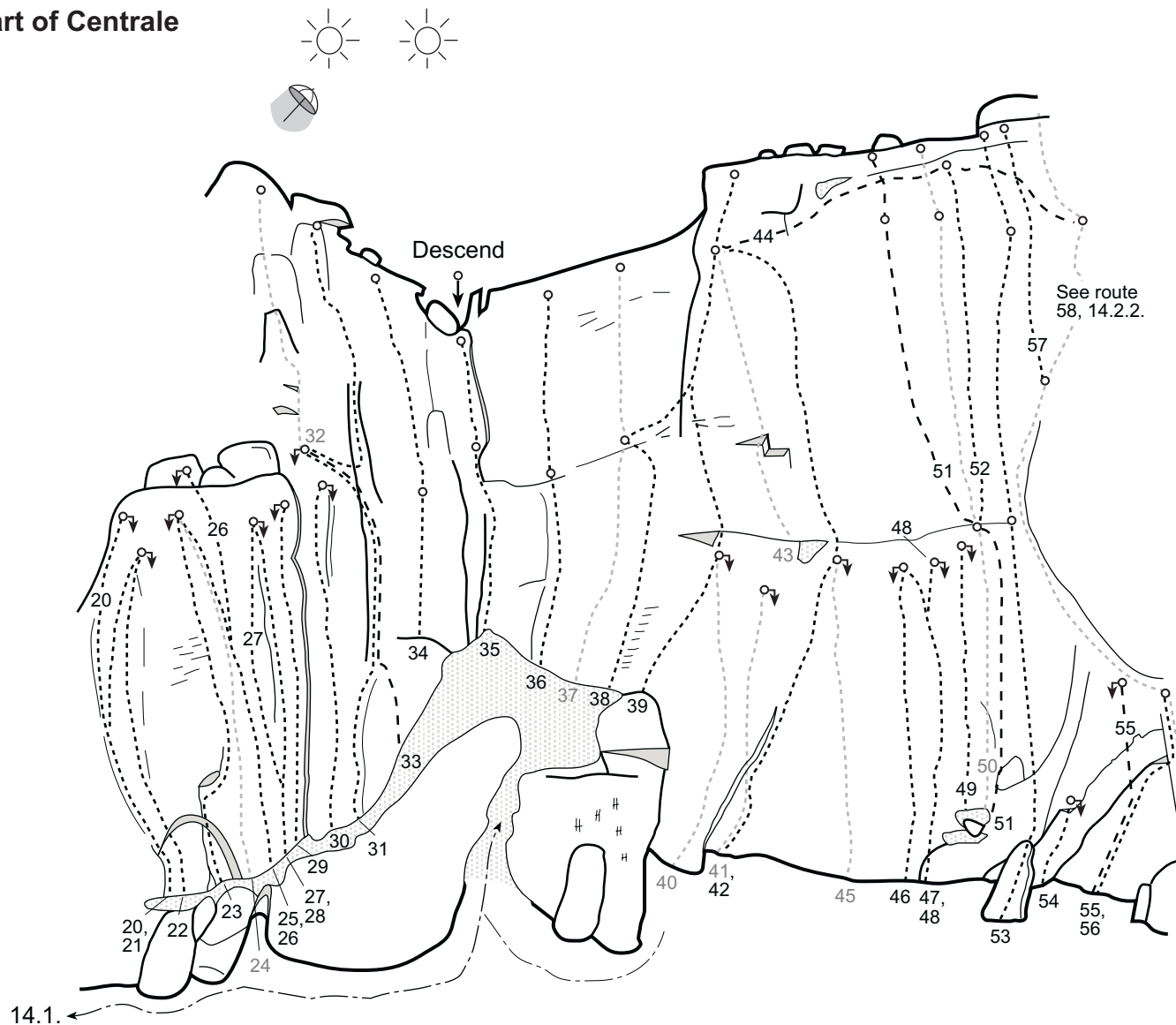

## 14.2.2. Monte Cucco, Settore Centrale

West, North-West

40 m. Multi Pitch up to 100 m.

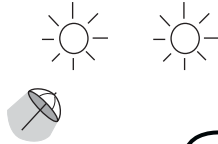

- |                                    |           |
|------------------------------------|-----------|
| 58. Il Tetto (80 m.)               | 5c,6b,6a  |
| 59. Diretta al Tetto (70 m.)       | 6b,4a,5c  |
| 60. Le Toit                        | 7a        |
| 61. Vecchi grilli                  | 6a        |
| 62. Collaborazione (70 m.)         | 5b        |
| 63. Brancaleone                    | 6a        |
| 64. Effetto Notte                  | 6a+       |
| 65. Soft cell                      | 6c+       |
| 66. Il muro di Berlino (80 m.)     | 6b,6b,6a+ |
| 67. Via di Li (60 m.)              | 6a,5c,4b  |
| 68. La pulce (80 m.)               | 5c,4c,4c  |
| 69. L'Alpino (60 m.)               | 6a,4b     |
| 70. Via di Là                      | 6b        |
| 71. Bianco e Nero                  | 6b+       |
| 72. Zone Pelviche                  | 6a        |
| 73. Mi dica bravucci               | 6a        |
| 74. Training sisters               | 6a+       |
| 75. Kamasutra                      | 7b+       |
| 76. Corpus Domini (100 m.)         | 6b,3b,4b  |
| 77. Toccata e fuga                 | 6a        |
| 78. Bucce d'Arancia                | 6b+       |
| 79. <i>Opti-Matti (needs gear)</i> | 6a        |
| 80. Il Gufo (100 m.)               | 5b,3b,4b  |
| 81. Souvenir de Buoux              | 7b        |
| 82. Top Gun                        | 6a+       |
| 83. Satori (80 m.)                 | 6a,6a+,5b |
| 84. Il Circo (60 m.)               | 6a,6b,5b  |
| 85. Ta-Kol                         | 7b        |
| 86. Ciscranna                      | 6a        |
| 87. Cocaine                        | 6b        |
| 88. Putacaso vi servisse un bigolo | 6a        |
| 89. Via degli Allievi (50 m.)      | 6a,5b     |
| 90. Vecchia Volpe                  | 6a        |
| 91. ?                              | 6a+       |

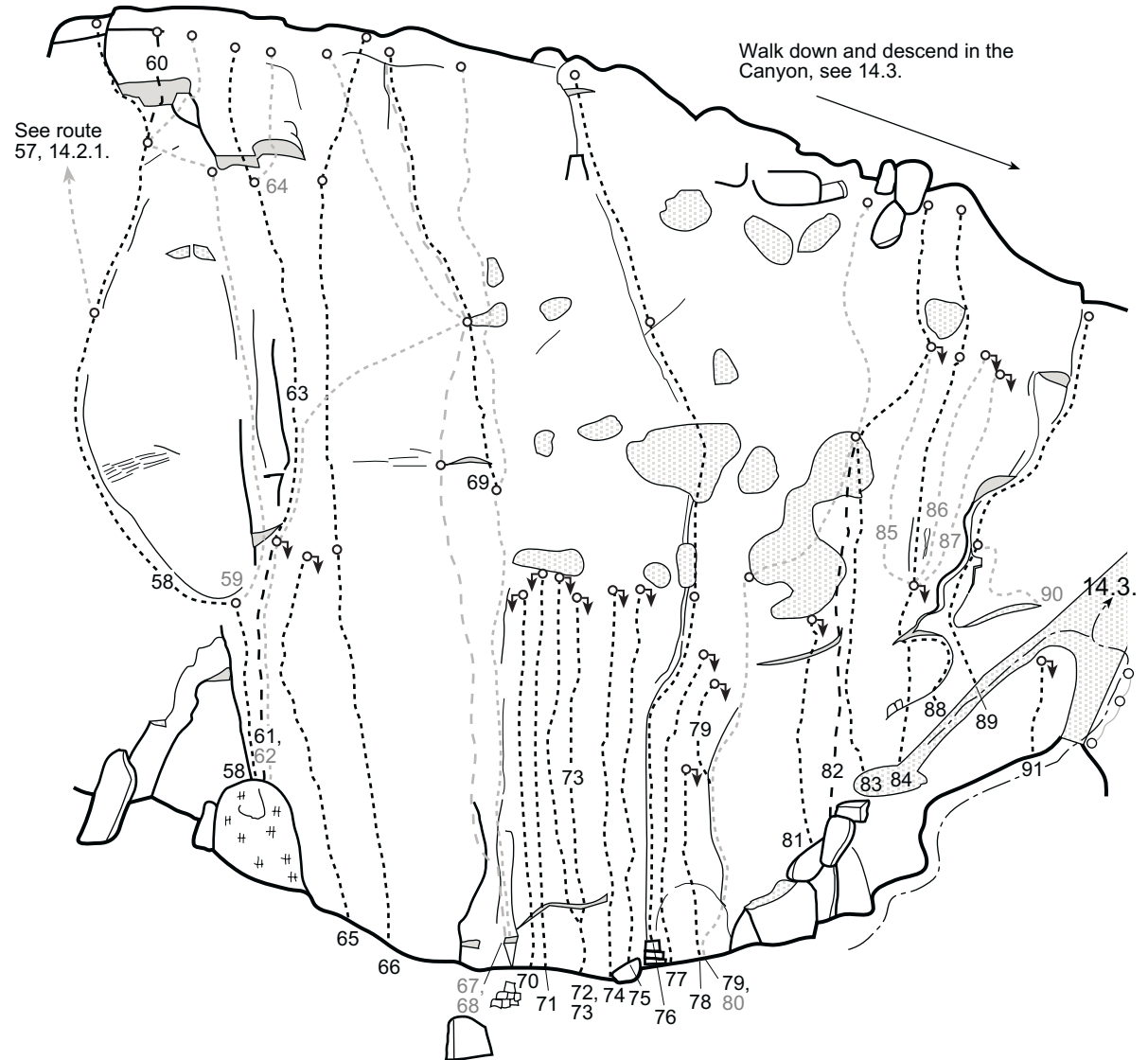

© coronn.com

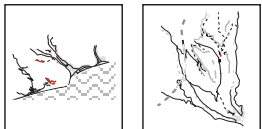

# 14.3. Monte Cucco, Il Canyon

20 m.

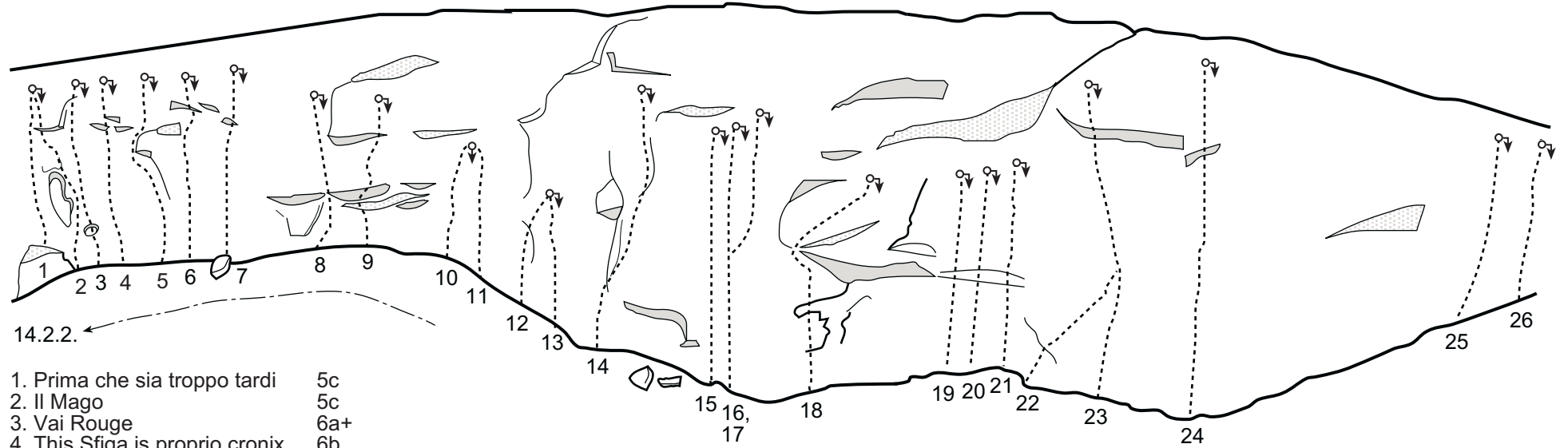

- 1. Prima che sia troppo tardi 5c
- 2. Il Mago 5c
- 3. Vai Rouge 6a+
- 4. This Sfiga is proprio cronix 6b
- 5. ? 6a
- 6. Abendrop 6a
- 7. La vie en Ros...Y 6b
- 8. Mi prende male 5b
- 9. Senza una lacrima 6a+
- 10. Cotica 6b
- 11. La Signora delle vallate dagli occhi tristi 6c
- 12. Steinhat sthet her 5c
- 13. Tendinix 7a+
- 14. Vivo da Re 6b
- 15. Ultissima 8a
- 16. Diretta super cyclisme ?
- 17. Super cyclisme 7c

- 18. Elvis the pelvis 6a
- 19. Rein ne va plus 5c
- 20. La Donna Vera 5c
- 21. Polvere di Stelle 6c+

- 22. Triumvirat 6b+
- 23. Variante a Triumvirat 7a
- 24. Metallica 6c
- 25. Another swing 6a+
- 26. Buchetti 5c
- 27. Ronchionissima 6a
- 28. Ester Pester 6b
- 29. ? ?

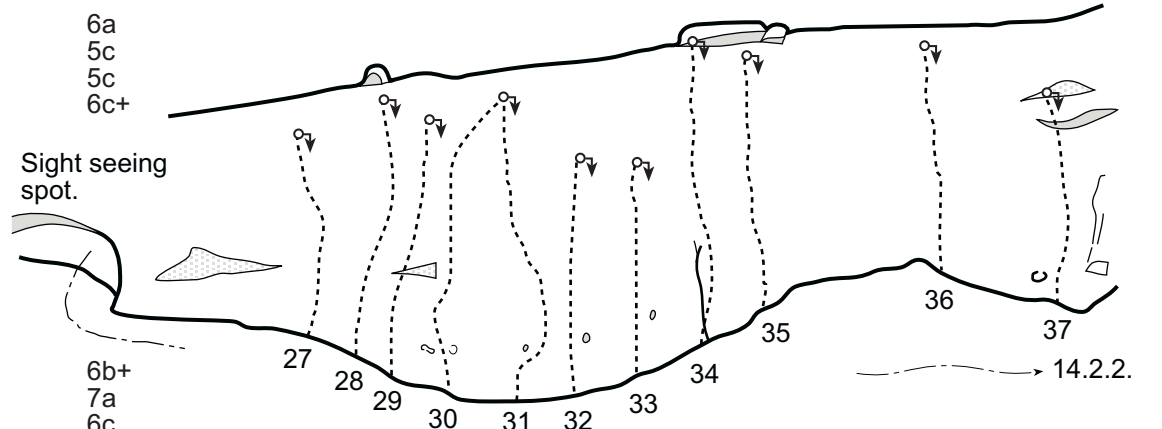

- 30. Scene di panico 6c+
- 31. Dottor Sottile 7a
- 32. Technicolor 6c
- 33. Non capisco ma mi adeguo 6b+
- 34. Jamin-a 6a+
- 35. Pupe e Pepite 6b+
- 36. Strano ma vero 6c
- 37. Kinderspiel 5c

© coronn.com

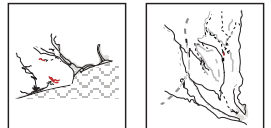

# 14.4. Monte Cucco, Fenia o Anfiteatro

West, North-West  
40 m. Multi Pitch up to 100 m.

Descend in the  
Canyon, see 14.3.

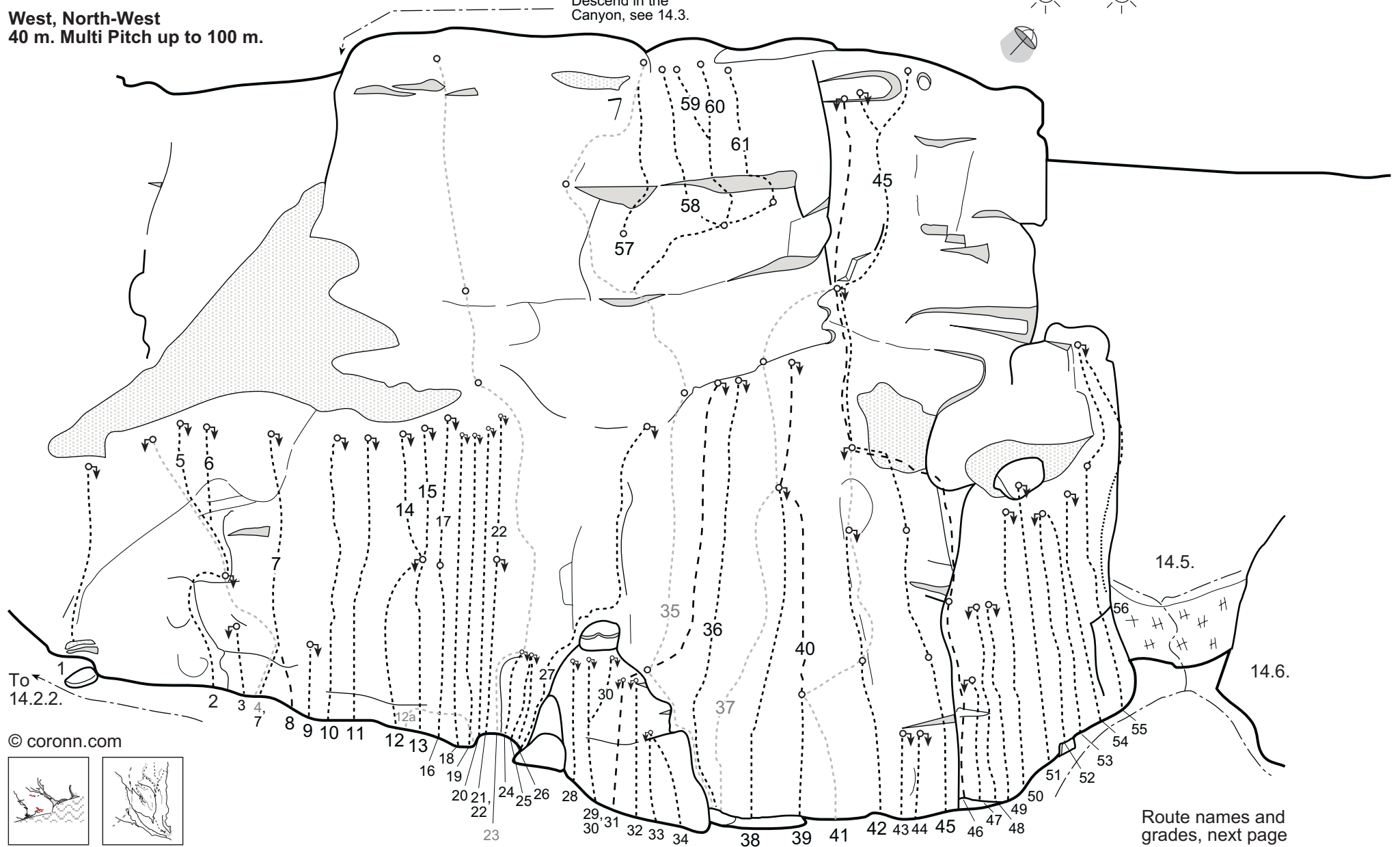
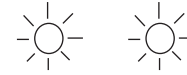

© coronn.com

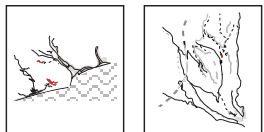

Route names and  
grades, next page

## 14.4. Monte Cucco, Fenia o Anfiteatro

### Route names and grades

1. ?	6a	31. Thriller (50 m.)	6a,6c
2. Angelino Primitiv	?	32. Emanuela	5c
3. Angoscia di velluto	6c+	33. Greetings from Frankenjura	6a+
4. Davide e Golia	6b,7a	34. Power of Love	6a+
5. ?	7a	35. Supervit (100 m.)	5b,6b+,6b,4b
6. Gaudi	7b	36. Gran Finale	7a+
7. Maniac	7c	37. Stravolgimento progressivo (70 m.)	6b,6a+,4
8. Microtest	7a+	38. Ultima Via	6c
9. Tanti Auguri	6c	39. Il Pittore	5c
10. Master of Bolts	7a+	40. Prillipoom	6c+,6a+
11. Satanasso	7a	41. Ottico (60 m.)	6a,5c,6a
12. Fabiozzi subisce ancora	5c	42. Zambarinik	6b,6c
12a. For Hannah (boulder)	7a+	43. Let' go Joppin	7a+
13. Rischia i Raschia	5b	44. Anthydral	6a+
14. Waterfall	7a	45. Mai più (70 m.)	6b,5b,5c,6a,5c
15. 4 WD	7a	46. <i>Diedro Rosso (needs gear)</i>	5c,5b,4
16. 10 HP	6a+	47. Fachirella	7a
17. Turbo Diesel	7a	48. Andate via	6b
18. Baci da Rio	7a	49. Welcome martina	6b
19. Senza Gemelli	7a	50. Cala Trinchetto	6a+
20. Ubrecche	6c+	51. Oggi in Stereo	6a+
21. Coconut	6c	52. Domani in Mono	6a
22. Fitzcarraldo	6b+	53. Pigiama antigrafitazionale	5c
23. Mura di Anagor (90 m.)	5c,6b,6c	54. Biancachiappa e le sette mani	6a+
24. Anche gli Angeli mangiano i Fagioli	6a+	55. Metanolo	6a,6b
25. E trovi il Grigio (50 m.)	6b,6c	56. Spigolo dei meticci	6c+
26. Dobermann	6a	57. Coralie	7a+
27. <i>Variante Bassa a Supervit (needs gear)</i>	5b,5b	58. Era il 38 Luglio e faceva molto caldo	7a+
28. Joe	6a+	59. Ottavo cielo	7c+
29. Siringa Giuliva	5c	60. Settimo cielo	?
30. Fame d'Erba	5c	61. Myto	?

© coronn.com

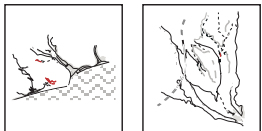

## 14.5. Monte Cucco, Piccolo Canyon

20 m. Multi Pitch up to 45 m.

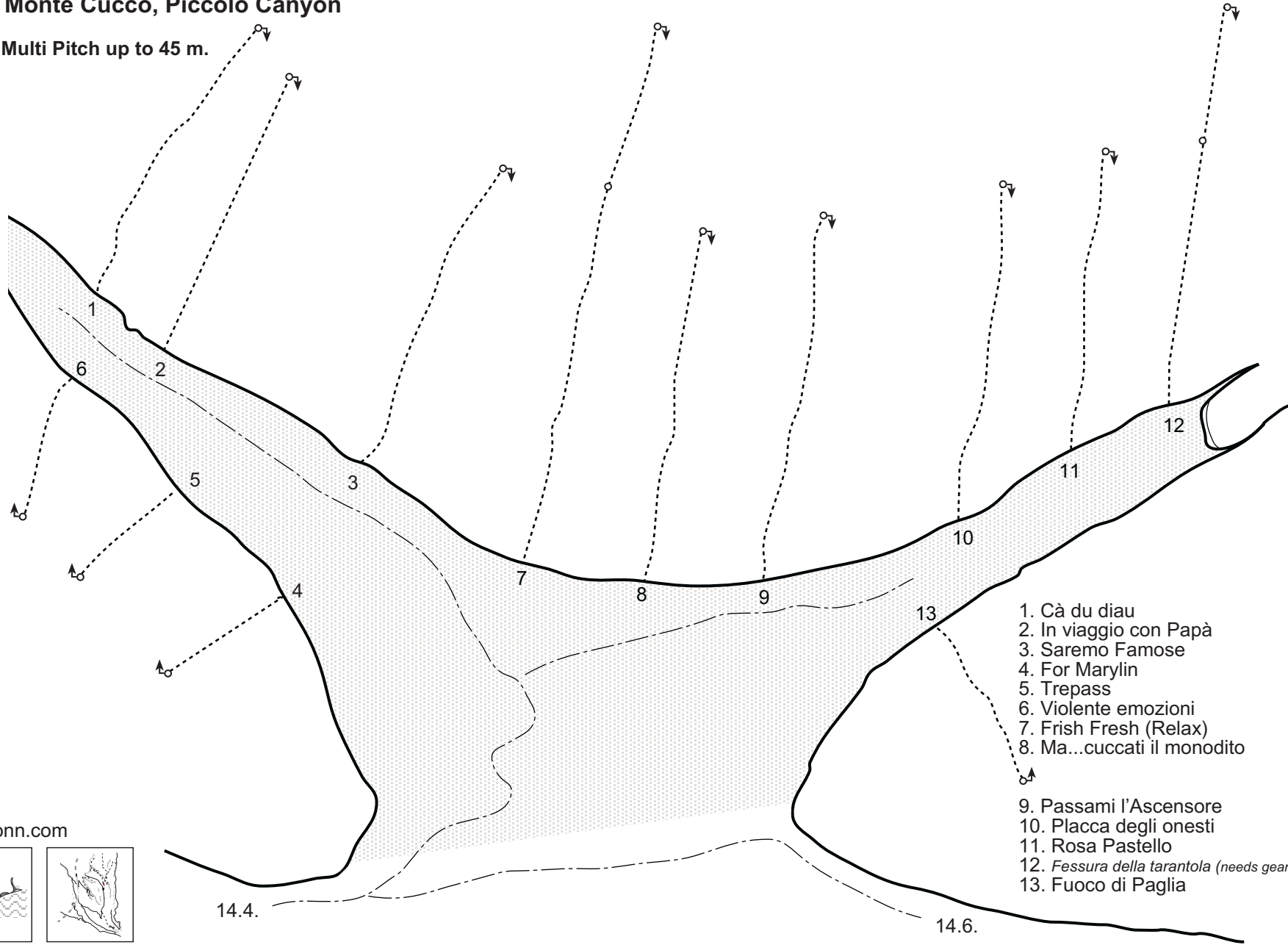

- |   |         |
|---|---------|
| 1. Cà du diau                                   | 6a+     |
| 2. In viaggio con Papà                          | 6a      |
| 3. Saremo Famose                                | 6a+     |
| 4. For Marilyn                                  | 7c      |
| 5. Trepass                                      | 7b      |
| 6. Violente emozioni                            | 7a      |
| 7. Frish Fresh (Relax)                          | 6a+,6a+ |
| 8. Ma...cuccati il monodito                     | 6a+     |
| 9. Passami l'Ascensore                          | 6c+     |
| 10. Placca degli onesti                         | 6c      |
| 11. Rosa Pastello                               | 7a+     |
| 12. <i>Fessura della tarantola (needs gear)</i> | 5b,5c   |
| 13. Fuoco di Paglia                             | 6a      |

© coronn.com

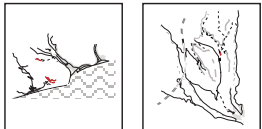

14.4.

14.6.



## 14.6. Monte Cucco, Campanile e Placca del Polpaccio and Sahara Wall e Machetto

N 44° 12.691'  
EO 08° 19.897'

West  
30 m. Multi Pitch up to 100 m.

- |                                   |        |
|-----------------------------------|--------|
| 1. Diretta al campanile (60 m.)   | 6a     |
| 2. Normale al Campanile (60 m.)   | 4c     |
| 3. Variante Nord                  | 6b     |
| 4. Mudra                          | 7a     |
| 5. Pista che scavo a vista...     | 6c+    |
| 6. Decadenza                      | 7b     |
| 7. Glass Spider                   | 6b+    |
| 8. Corto Cortese                  | 6a     |
| 9. Invidia parlante               | 6a+    |
| 10. Per Elisa (60 m.)             | 6a     |
| 11. Fisiognomica                  | 7b+    |
| 12. Icaro                         | 7a+    |
| 13. Stanza dei Bottoni            | 6b+    |
| 14. Ultimi Fuochi                 | 6a     |
| 15. Lupunciuk                     | 6a+    |
| 16. Lupo Mannaro                  | 5b     |
| 17. Uccellacci, Uccellacci        | 7a+    |
| 18. Danza dei nervi               | 6c+    |
| 19. In Salah                      | 7a+    |
| 20. Aut-Aut                       | 7b+    |
| 21. Occhi storti per mino reitano | 7b+    |
| 22. Rubando le nuvole             | 7a     |
| 23. Via delle gomma (70 m.)       | 6a,6b  |
| 24. Priscilla (needs gear)        | 3,6a   |
| 25. Machetto (60 m.)              | 6a,6c+ |
| 26. 57 Puffi Blu                  | 6b     |
| 27. Tigrotti della Magnesia       | 6b+,6b |
| 28. Gran turismo                  | 7a+,6b |
| 29. Cristalli di Luna             | 7a+    |
| 30. Crioterapia digitale          | 7a,6c  |
| 31. Dolce tabù                    | 7b+    |
| 32. Aras Eleinad                  | 7b+    |

- |                    |        |
|--------------------|--------|
| 33. Highlander     | 7a+    |
| 34. Rimedi Topici  | 6c+    |
| 35. Hartman        | 6a,6b+ |
| 36. ?              | ?      |
| 37. Topo Mix       | 6b+    |
| 38. Ultimo Buco    | 6a+    |
| 39. Scianca miande | 6a,6a+ |
| 40. Kazoooca       | 6b,6a  |

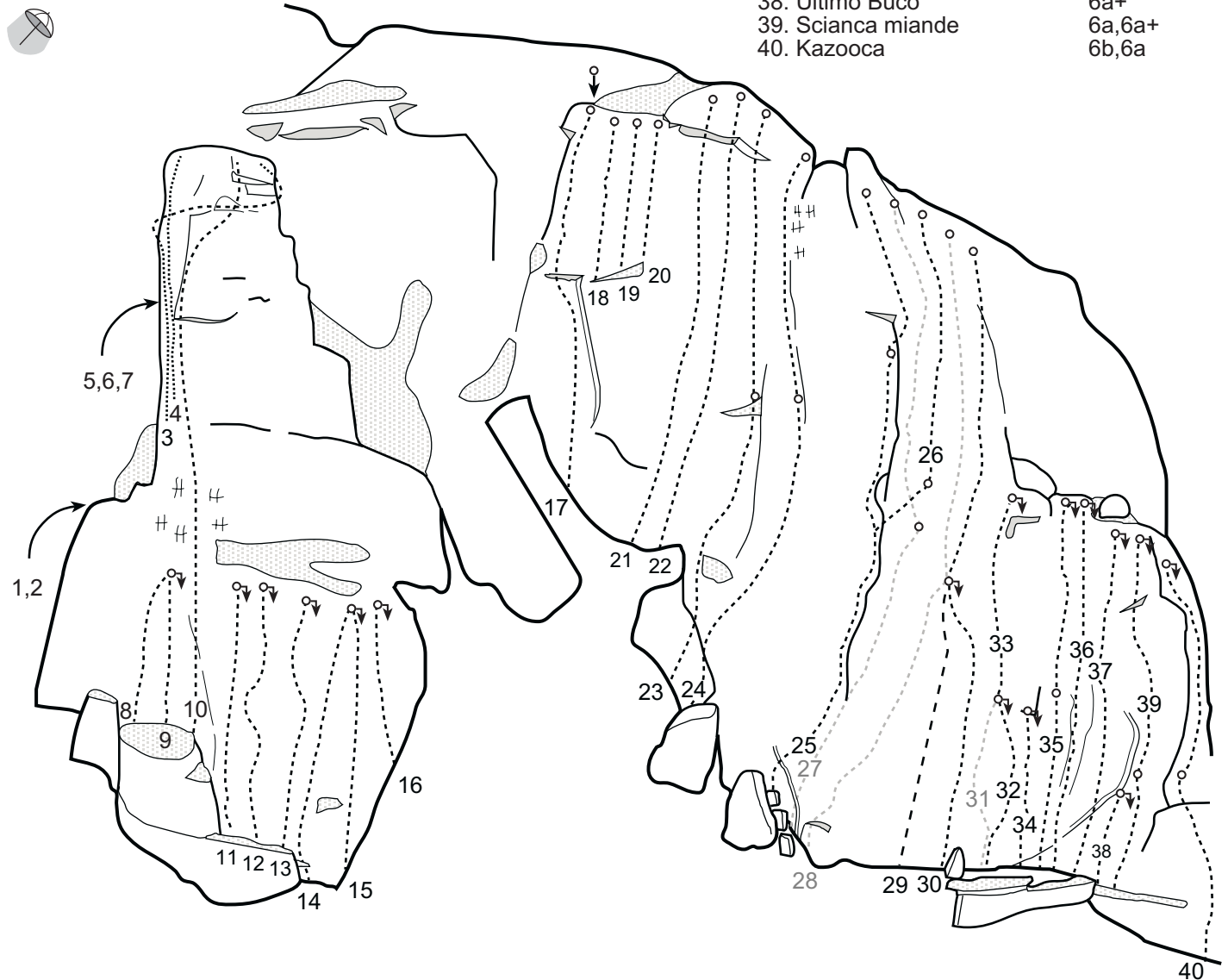
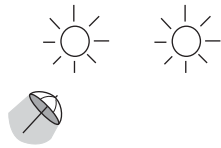

© coronn.com

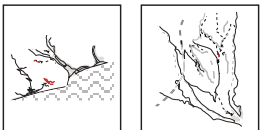

# 15 and 16. Rian Cornei, Key-map

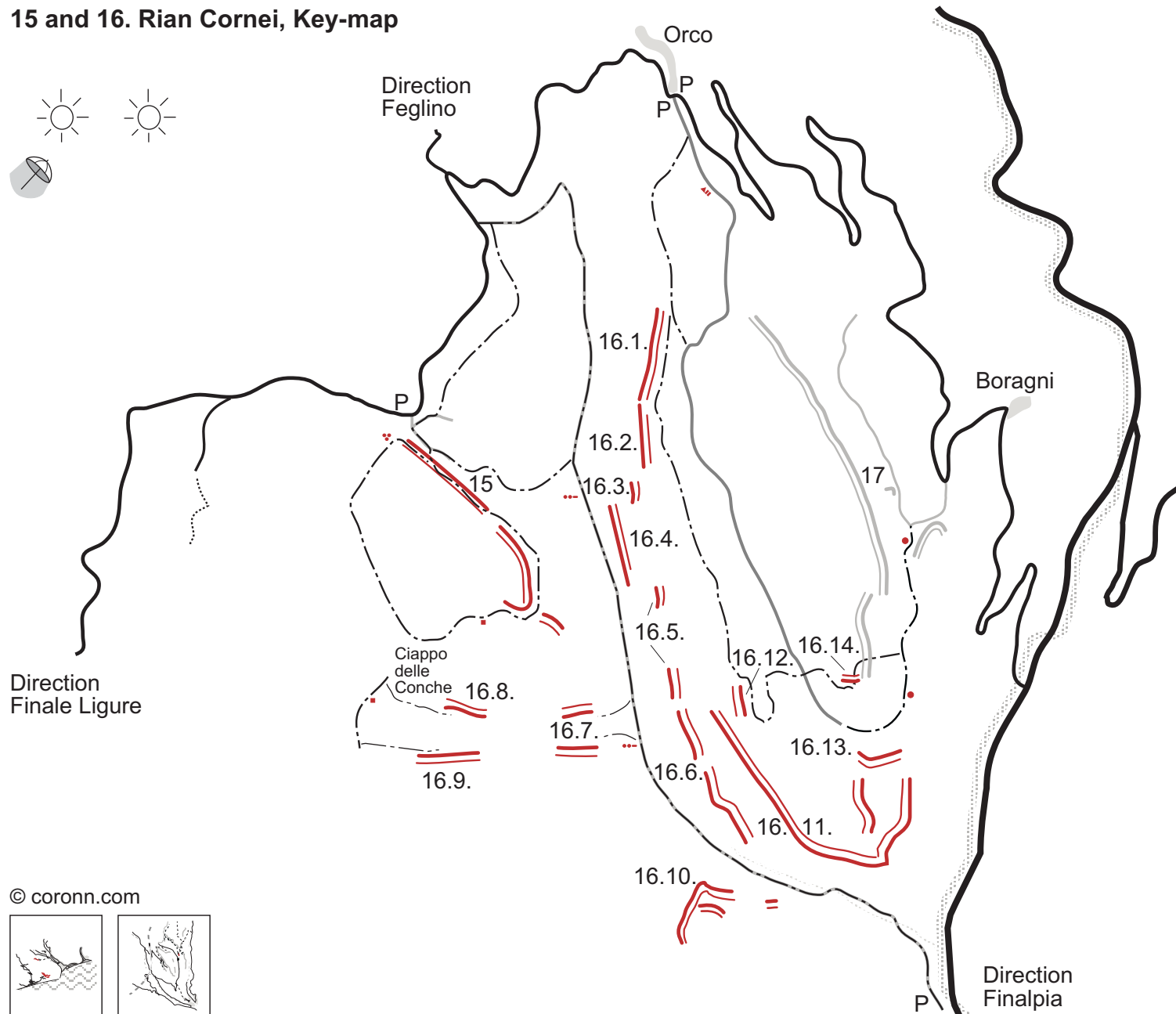
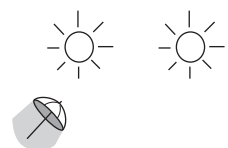

# 15. Rian Cornei, Italsider

N 44° 12.856'  
EO 08° 20.314'

East, North-East  
30 m.

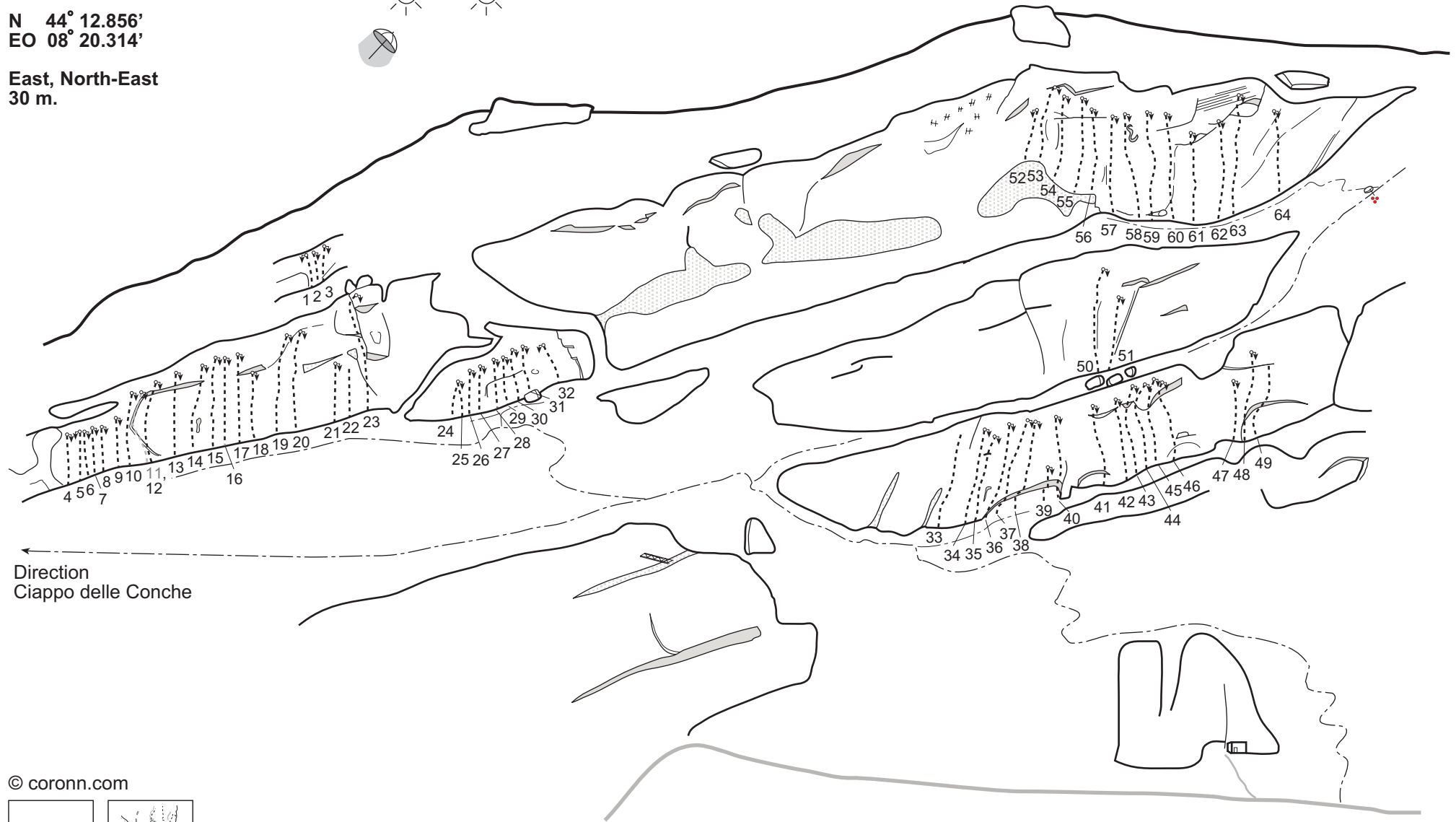
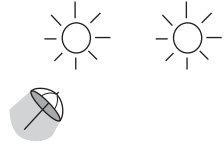

Direction  
Ciappo delle Conche

© coronn.com

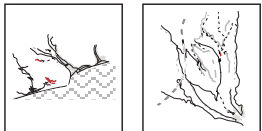

Route name, grades and map on next page



## 15. Rian Cornei, Italsider

### Settore principale

- |                                  |     |
|----------------------------------|-----|
| 1. Lasciati andare               | ?   |
| 2. Troglodita                    | 7b+ |
| 3. Vengo                         | 6c  |
| 4. Un occhio di Riguardo         | 5c  |
| 5. Yury chechi                   | 6a  |
| 6. L'Anormale                    | 6a  |
| 7. Sangue cioccolata e magnesite | 6a+ |
| 8. Cielo artico                  | 6a  |
| 9. Sagra del fuoco               | 5c  |
| 10. Margherita...che Pizza       | 5c  |
| 11. Sapin                        | 6a  |
| 12. Via dei Pigmei a cornei      | 6a+ |
| 13. Recco Team                   | 6b  |
| 14. Se non passo non passo       | 6b  |
| 15. Me sun ciccao                | 6c  |
| 16. E la panza avanza            | 6b+ |
| 17. Via del Ghiro vagante        | 5c  |
| 18. Non ci passo credere         | 6a  |
| 19. Finche' c'e' roccia...       | 5c  |
| 20. Chiodando sotto la pioggia   | 5c  |
| 21. Miami beach                  | 5b  |
| 22. Stefania on the rocks        | 5a  |
| 23. Generale stai sulla collina  | 6a  |

### Gelateria del Bosco

- |                   |     |
|-------------------|-----|
| 24. Profiterol    | 5b  |
| 25. Baba'         | 6a  |
| 26. Baci di dama  | 6a  |
| 27. Meringa       | 6a  |
| 28. Fior di Latte | 6b  |
| 29. Ciocori'      | 6a+ |
| 30. Ice cream     | 6a  |
| 31. Bigne'        | 6a  |
| 32. ?             | ?   |

© coronn.com

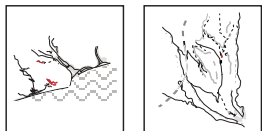

### Un Domani

- |                            |     |
|----------------------------|-----|
| 33. Re delle placche       | 7a+ |
| 34. C'e' su'               | 6a+ |
| 35. Butterfinger           | 7a+ |
| 36. Regina di Cuori        | 6a+ |
| 37. Solotrip (In extremis) | 6a  |
| 38. Un Domani              | 7a  |
| 39. Ritmo                  | 6b  |
| 40. Arena della fantasia   | 6a+ |
| 41. Ematoma                | 6c  |
| 42. Lavori stradali        | 6a+ |
| 43. Pindacio               | 6a+ |
| 44. La Grande Corsa        | 6b  |
| 45. Primo Amore            | 6a+ |
| 46. Minigolf               | 6b  |
| 47. Contadini si nasce     | 6b+ |
| 48. Parassiti si diventa   | 6b  |
| 49. Bellixeddu             | 6a+ |

### Burrida

- |                          |    |
|--------------------------|----|
| 50. Rigurgito di Burrida | 6c |
| 51. Occhi Lucidi         | 5c |

### Falesia dell' Invidia

- |                                   |     |
|-----------------------------------|-----|
| 52. Nice che dice                 | 6c  |
| 53. Boh!                          | 6b  |
| 54. L'Incontrollabile Mr. Control | 6b  |
| 55. Bidibibodibu                  | 6a  |
| 56. Albareto Show                 | 7b  |
| 57. A foa du bastettu             | 6a+ |

### How to find the crag:

Drive from Finale Ligure in the direction of the highroad. Turn right in the direction of Finalborgo and continue through the town on small roads. Follow signposts for Feglino. In a T-junction, turn right in the direction of Orco. Pass the Refuge and continue about 1 km. On the right you will find a small road that leads to a small village. Park on a lay bay and follow this road by foot. In the T-junction, hold right and turn right on to the marked track just before a quarry. You will reach the first crag, "Un Domani", after about 10 minutes.

You can also reach the crag by driving from Finalpia in the direction of Magnone/S. Filippa. Turn left in the direction of Boragni/Orco and pass both these villages. About two kilometres later you will see the crag.

- |                                     |     |
|-------------------------------------|-----|
| 58. Olhos de Brilantes              | ?   |
| 59. Continuando a chiedermi perche' | 7b+ |
| 60. La persuasione e la retorica    | 6c+ |
| 61. Fenia in agonia                 | 7b  |
| 62. Spit e spot                     | 7a+ |
| 63. Sofismi e sadismi               | 6c+ |
| 64. E musse du Riccardo             | 6b  |

Follow the red quadrangular marks and pass Italsider in the direction of "Ciappo delle Conche". Just before the crest, turn left and you will find another little crag, Falesia del Castagno (No Topos);

- |                       |    |
|-----------------------|----|
| 1. Blues per Manitu'  | 6b |
| 2. Frammenti di Cielo | 6a |



# 16.1. Rian Cornei, Placconata Settore Sinistro

West  
30 m.

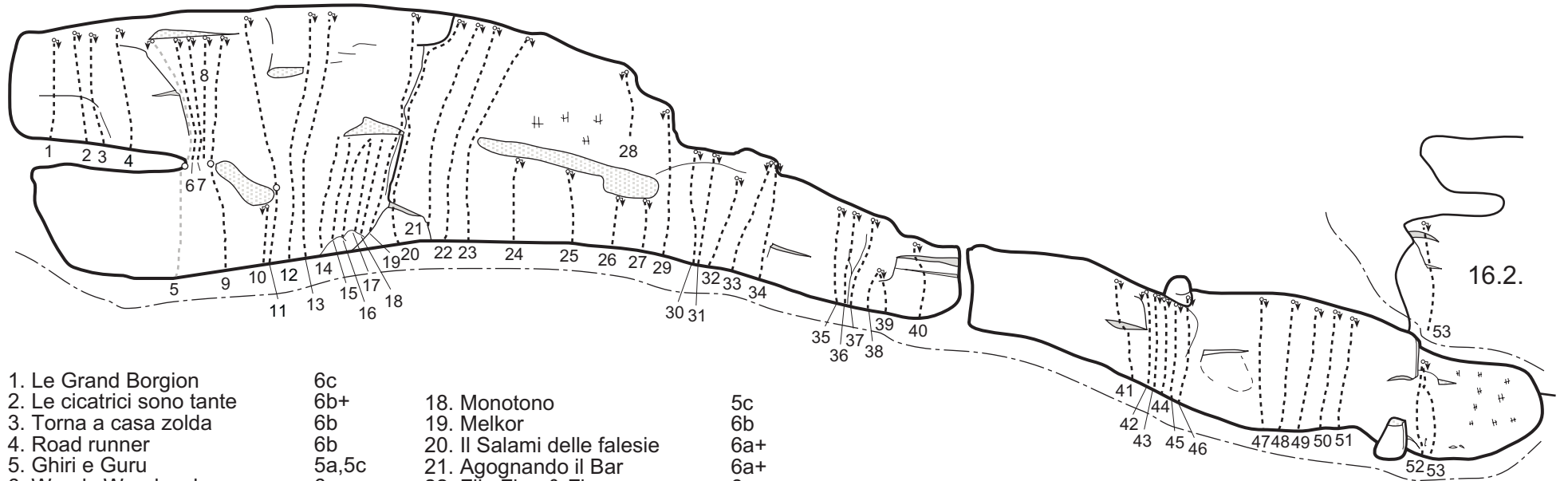
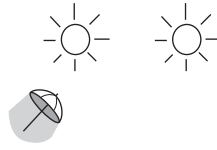

- |                            |       |                             |     |                           |       |
|----------------------------|-------|-----------------------------|-----|---------------------------|-------|
| 1. Le Grand Borgion        | 6c    | 18. Monotono                | 5c  |                           |       |
| 2. Le cicatrici sono tante | 6b+   | 19. Melkor                  | 6b  |                           |       |
| 3. Torna a casa zolda      | 6b    | 20. Il Salami delle falesie | 6a+ |                           |       |
| 4. Road runner             | 6b    | 21. Agognando il Bar        | 6a+ |                           |       |
| 5. Ghiri e Guru            | 5a,5c | 22. Flip Flop & Fly         | 6a+ |                           |       |
| 6. Woody Woodpecker        | 6a+   | 23. Volente o Volante       | 6b  |                           |       |
| 7. Geppo                   | 6a    | 24. Free Joint              | 5c  |                           |       |
| 8. Grazie non fumo         | 6a    | 25. Giovani e Ribelli       | 5c  |                           |       |
| 9. Classic in spit         | 5c,6a | 26. Modello Base            | 6a+ |                           |       |
| 10. La Squaw               | 6a+   | 27. Aldo avanzini           | 6a+ |                           |       |
| 11. Aziun nau              | 6b,6b | 28. Trimo non farti toccare | 6b+ |                           |       |
| 12. Il Franco dei Salami   | 6a+   | 29. Affitansi scale         | 6c  |                           |       |
| 13. Cicicipici             | 6a+   | 30. La storia infinita      | 6b  |                           |       |
| 14. Inject the Venom       | 6c    | 31. Art of noise            | 6a+ |                           |       |
| 15. Via del Kaiser         | 6c    | 32. Il gruppo T.N.T.        | 6a  |                           |       |
| 16. I fagioli sono buoni   | 6a+   | 33. E' Ora di basta         | 6a  |                           |       |
| 17. Squib's                | 5c    | 34. Arsura vaginale         | 6a+ |                           |       |
|                            |       | 35. Innominata              | 6b  | 41. Space dance           | 7a    |
|                            |       | 36. Turisti fai de te       | 6b  | 42. Honey Moon            | 6c    |
|                            |       | 37. Pollastro e patatina    | 6b+ | 43. Marcus                | 6b    |
|                            |       | 38. Buon Compleanno         | 6b+ | 44. SuperMatteo           | 5c    |
|                            |       | 39. El Porompompero         | 6a  | 45. One day in Paradise   | 6b    |
|                            |       | 40. Pinzimonio              | 6a+ | 46. Coocolino II          | 6c+   |
|                            |       |                             |     | 47. Gli occhi di Sara     | 6a+   |
|                            |       |                             |     | 48. Lummerland            | 6a    |
|                            |       |                             |     | 49. Roger Rabbit          | 5c    |
|                            |       |                             |     | 50. Nesquik               | 6a    |
|                            |       |                             |     | 51. Gold rush             | 6b    |
|                            |       |                             |     | 52. Rambo Kid             | 6b    |
|                            |       |                             |     | 53. Scherzi di Arlecchino | 6a,5c |

© coronn.com

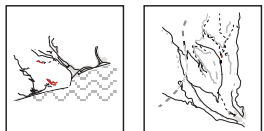

## 16.2. Rian Cornei, Avancorpo

N 44° 12.797'  
EO 08° 20.679'

West, South-West  
45 m.

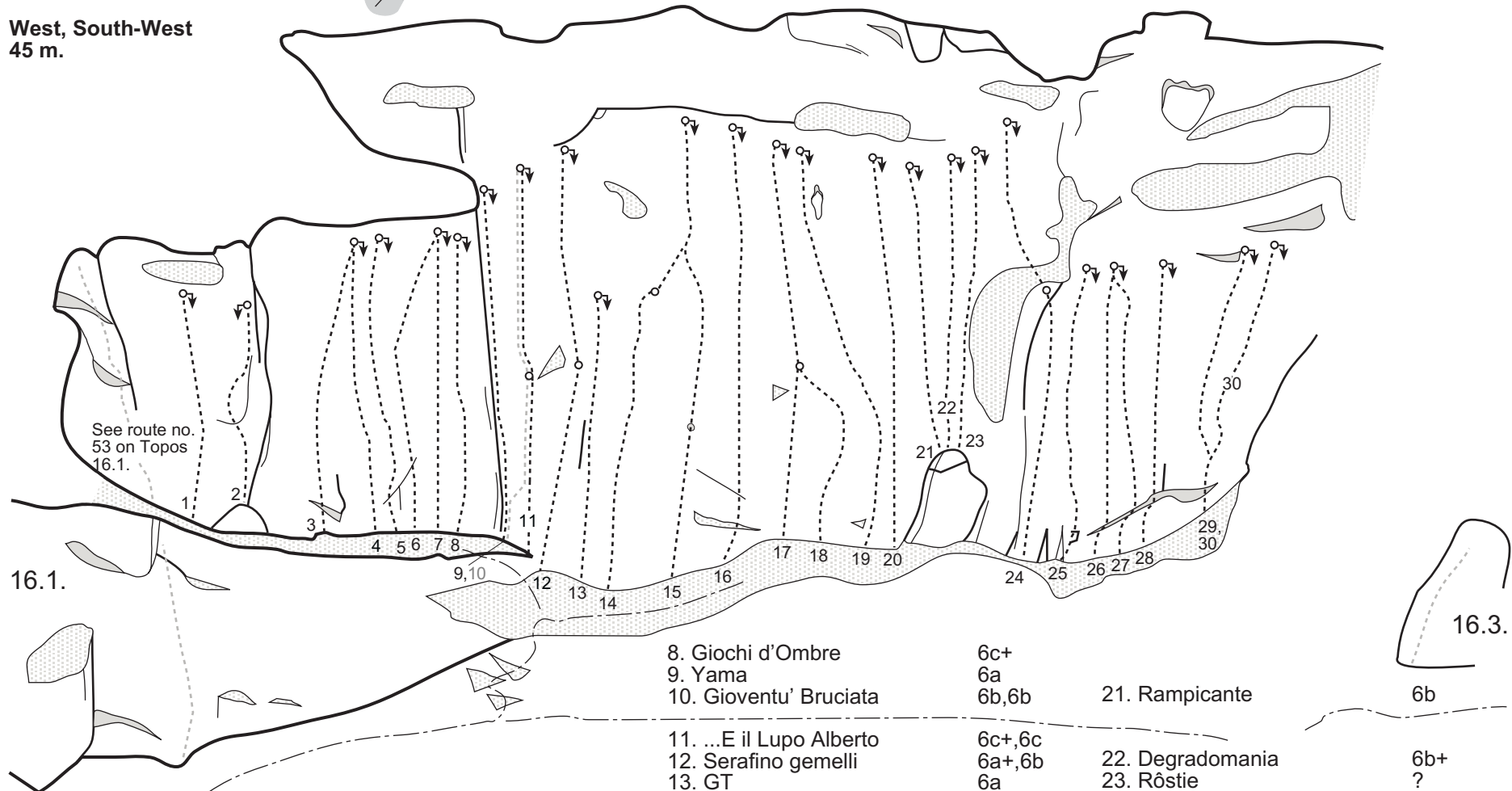
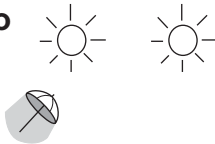

16.1.

16.3.

© coronn.com

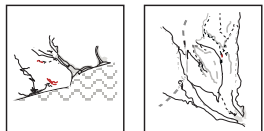

- 1. La ruta del Tempo
- 2. Dobro
- 3. Giochi proibiti
- 4. La Vendetta di Peperinik
- 5. Sputnik
- 6. Sogno di un Clown
- 7. Foxtrot

- 6b+
- 6a
- 6a+
- 6b+
- 6b
- 6a+
- 6a+
- 6a

- 8. Giochi d'Ombre
- 9. Yama
- 10. Gioventu' Bruciata
- 11. ...E il Lupo Alberto
- 12. Serafino gemelli
- 13. GT
- 14. Dito Ditino
- 15. Abbio'
- 16. Soldi per niente
- 17. Il Barone rampante
- 18. Prigionieri del Sole
- 19. Lo sai Ehhh...
- 20. Ad Ovest di Paperino

- 6c+
- 6a
- 6b,6b
- 6c+,6c
- 6a+,6b
- 6a
- 6b
- 6c+
- 7a
- 7a+
- 6c
- 6b
- 6c+

21. Rampicante

- 22. Degradomania
- 23. Rôstie
- 24. Verde Blu
- 25. La galline Marta
- 26. Nei secoli fedele
- 27. The long run
- 28. Dadaumpa
- 29. Osmosi
- 30. Dimmi il numero

6b

- 6b+
- ?
- 6a,5c
- 5c
- 6b+
- 6a+
- 6b
- 7a+
- 6a

### 16.3. Rian Cornei, Avancorpo

West, South-West  
20 m.

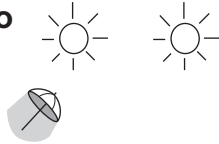

To  
16.2.

- |                               |     |
|-------------------------------|-----|
| 1. Razmataz 10                | 6c  |
| 2. Ryobi                      | 6b  |
| 3. Breve storia del tempo     | 7a  |
| 4. Pappa Cica                 | 6b+ |
| 5. La mia testa e' una nuvola | 7b  |
| 6. Destino animale            | 7a  |
| 7. Profondo Rosso             | 6b  |

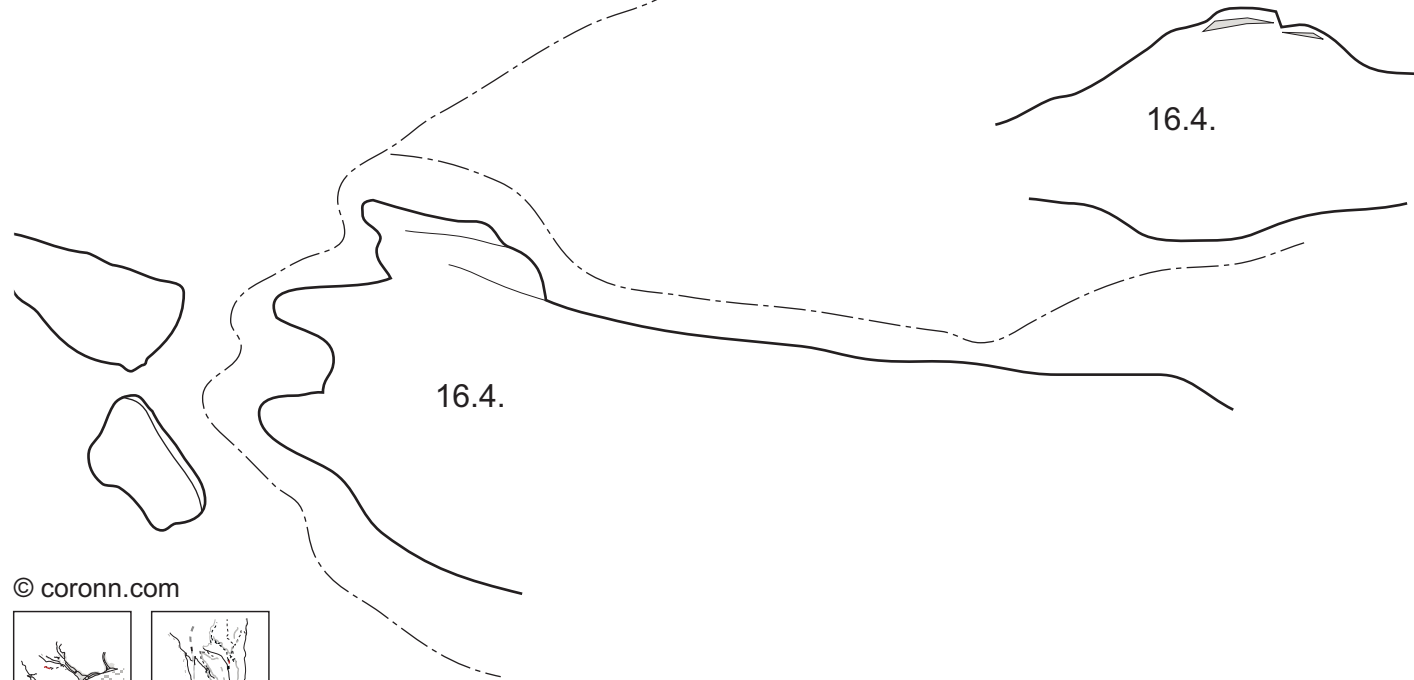
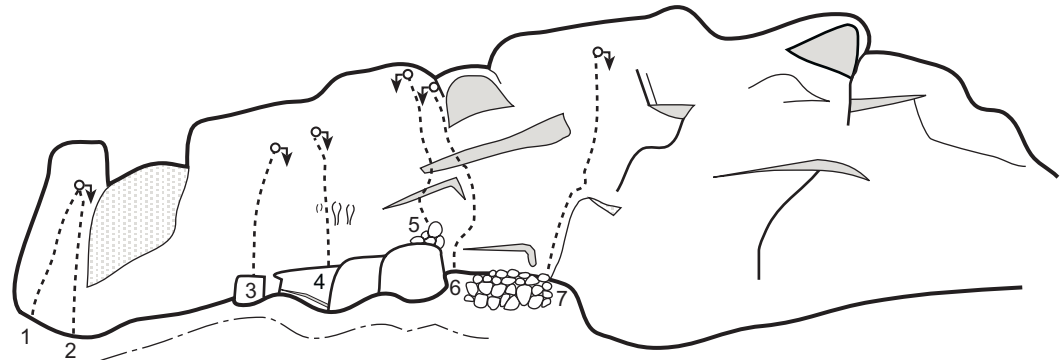

© coronn.com

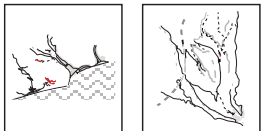

## 16.4. Rian Cornei, Falesia dell'Eco

N 44° 12.666'  
EO 08° 20.632'

West, South-West  
25 m.

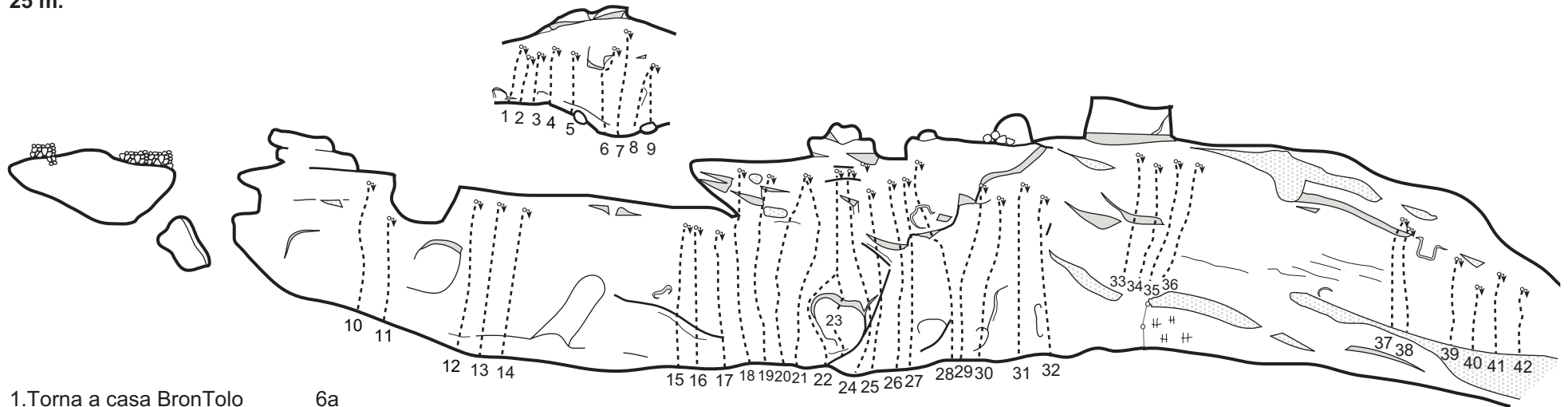
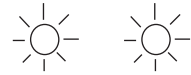

- 1. Torna a casa Bron Tolo
- 2. Fattonik
- 3. Squit Squit
- 4. Eu e tu
- 5. I miei primi 18 anni
- 6. Nebbia in Val Cornei
- 7. Ole e trufa
- 8. Il Tapezziere
- 9. ...E la presa non c'e' piu'
- 10. Trapan
- 11. Alien
- 12. Bejamin
- 13. Rita
- 14. Gatto Silvestro
- 15. Paperinik

- 6a
- 6a+
- 6a
- 6a+
- 6b+
- 6b
- 7a
- 7a
- 6b
- 5c
- 6a
- 5c
- 5c
- 5b
- 6a+

- 16. Oca enri
- 17. Sun Misciu
- 18. Spun Ciun
- 19. Magnesite Erotica
- 20. Climbonsai
- 21. Carmen
- 22. Variante Novi
- 23. Via Novi
- 24. Via del Giovane Paolo
- 25. Conquista la Fisioterapista
- 26. Il Cerbiatto
- 27. Fammi sognare
- 28. Non raitate sul tornamente
- 29. Vecchietto volumetrico
- 30. Mary per sempre
- 31. Lo gnomo e la Luna
- 32. A Mussa da Giaruna
- 33. Magici suoni
- 34. Bucare stanca
- 35. Joe Condor
- 36. Devil

- 6a
- 6a
- 5c
- 6a
- 6a+
- 6a+
- 6c
- 6c
- 6a+
- 6a
- 6a
- 6a
- 6b
- 6a+
- 6a
- 5c
- 6b+
- 6a+
- 6a
- 6a
- 6c+

- 37. Rammannaia
- 38. Wonder Betta
- 39. La Vispa Teresa
- 40. Magic moment
- 41. Ciao Heidi
- 42. Porno diva

- 6b+
- 6b
- 6c
- 6b+
- 6b+
- 6c+

© coronn.com

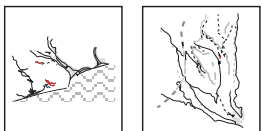



## 16.5. Rian Cornei, Falesia della Tranquillità and Falesia del Guru

West, South-West  
15 m.

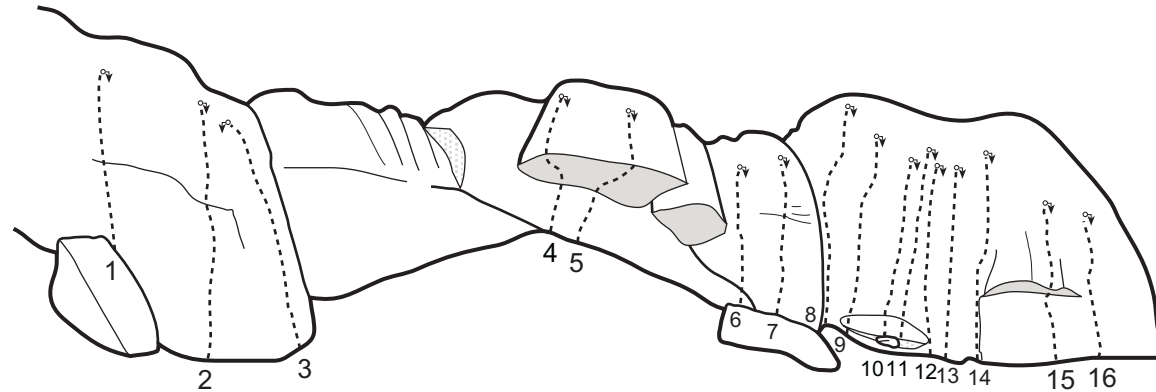
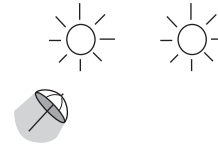

- |                                |     |
|--------------------------------|-----|
| 1. Fetengsi                    | 6b  |
| 2. Tempo perso                 | 5c  |
| 3. Margherita 5500             | 5c  |
| 4. Momenti di panico           | 6a+ |
| 5. Gheimu mi e u franco        | 6b  |
| 6. Folletto del Bosco          | 6c+ |
| 7. Fatti i cazzi tuoi confucio | 6c+ |
| 8. Cattivik                    | 6a+ |
| 9. Bar Central                 | 6b  |
| 10. Hot Chocolate              | 6b  |
| 11. Immagine di un sogno       | 5c  |
| 12. Chiedendomi perche'        | 6a+ |
| 13. Sioux campoliverpool       | 6c  |
| 14. Trastullo e prismina       | 6b+ |
| 15. El trip l'e' mai trop      | 6a+ |
| 16. Zabadubie                  | 6a  |

- |                                    |     |
|------------------------------------|-----|
| 1. Jana                            | 6c  |
| 2. Local hero                      | 6c+ |
| 3. Des zuckende mann und das schaf | 6b+ |
| 4. Alternanza emotiva              | 6c  |
| 5. Danzig                          | 6b+ |
| 6. Diesel and dust                 | 6c  |
| 7. Quasi Modo                      | 6b  |
| 8. Alien remover                   | 6b  |
| 9. La Donna e l'arte del vino      | 5c  |
| 10. Hommage a' cinque litri        | 5c  |
| 11. Bangladesh                     | 6b  |

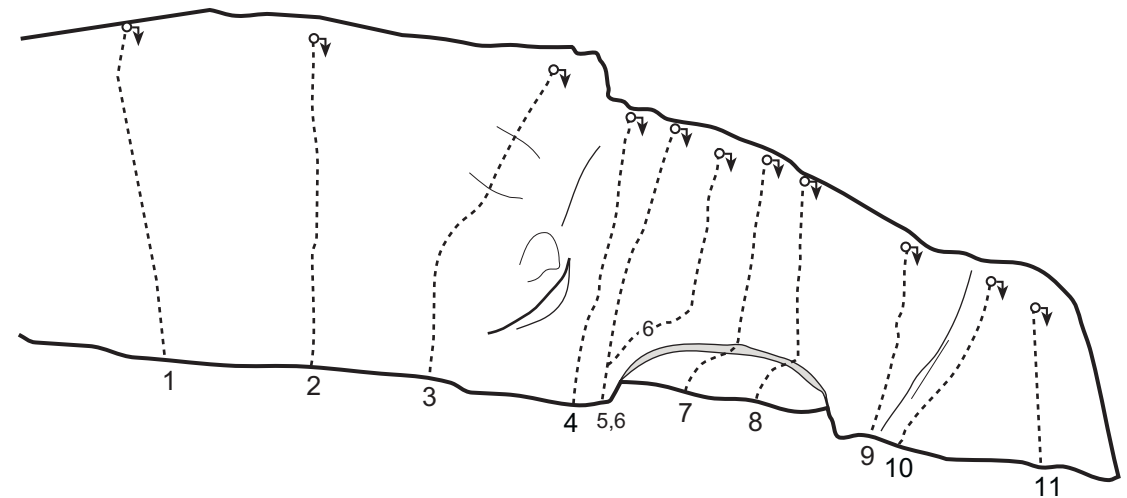

© coronn.com

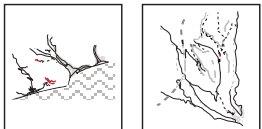

# 16.6.1. Rian Cornei, Falesia di Camelot

West, South-West  
25 m.

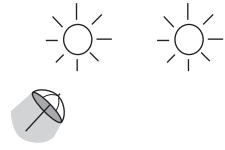

- |                         |     |                        |     |
|-------------------------|-----|------------------------|-----|
| 1. Mezze Verita'        | 6b  | 9. Le pinetane         | 6a+ |
| 2. Masomanie            | 6a  | 10. E' ora di finirla  | 6b+ |
| 3. Bombs away           | 6b+ | 11. Diamante           | 6a+ |
| 4. Solingo              | 6c  | 12. Sliced Pineapple   | 7a  |
| 5. sandro Saba          | 6a  | 13. Demoe              | 6b+ |
| 6. Il Fiore di Berlino  | 6b  | 14. Artigli sul futuro | 7b  |
| 7. Un giorno di quiete  | 6b+ | 15. Frio               | 7a  |
| 8. Muliebris dignitatem | 6b+ | 16. Etilica            | 5c  |

© coronn.com

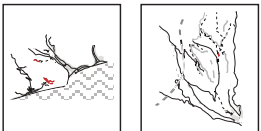

## 16.6.2. Rian Cornei, Falesia di Camelot

West, South-West  
25 m.

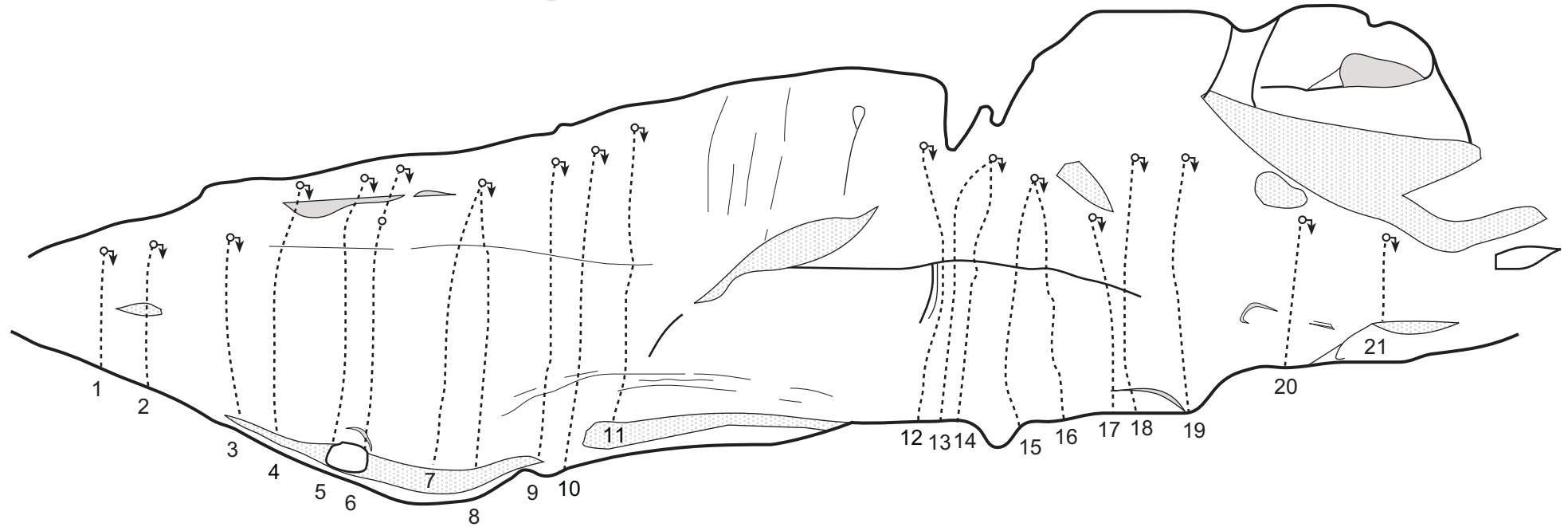
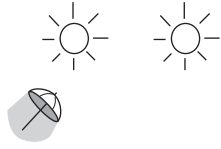

- |                        |     |                          |     |
|------------------------|-----|--------------------------|-----|
| 1. Tequila             | 6b  | 12. Tienimi Tienimi      | 6a+ |
| 2. Refugium peccatorum | 6b  | 13. Missing              | 6b  |
| 3. Rache fur wanda     | 6a+ | 14. Muy Pamplona         | 6b  |
| 4. trippuk             | 6c  | 15. Esquimia             | 6a+ |
| 5. Dream               | 6b+ | 16. Carry on             | 6b+ |
| 6. Angst               | 6b  | 17. Hispavox             | 6c+ |
| 7. Halloween           | 6c  | 18. Con le mani          | 6c+ |
| 8. Trazione fatale     | 6c+ | 19. Mesoterapia digitale | 6b  |
| 9. Metallica           | 6c+ | 20. Calimba              | 6a  |
| 10. Tirami su          | 7a  | 21. Ginevra              | 5c  |
| 11. Guns'n roses       | 6c  |                          |     |

© coronn.com

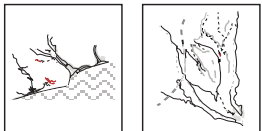

# 16.7. Rian Cornei, La Goletta

North  
15 m.

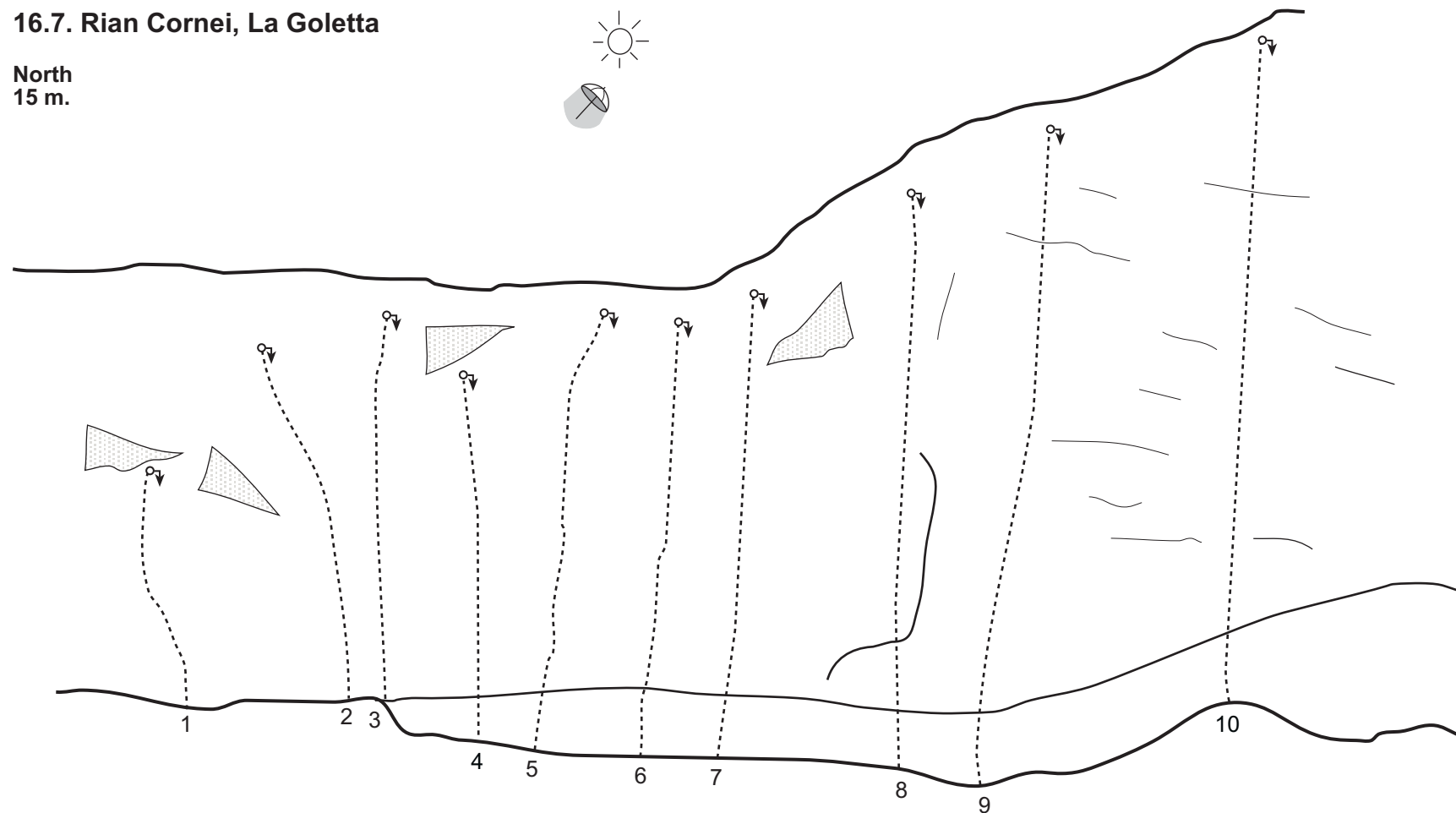

© coronn.com

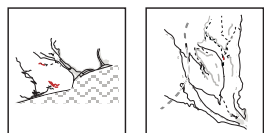

- |                        |    |  |     |
|------------------------|----|--|-----|
| 1. Tati                | 6a | On the other side of the valley, from left |     |
| 2. Facciamo pace       | 6a | to right (No Topos);                       |     |
| 3. Le Pippe di Alby    | 6a | 1. Oracle                                  | 6c+ |
| 4. Facciamo all' Amore | 6a | 2. Ma se ghe pensu                         | 6c+ |
| 5. "Brondolo"          | 6a | 3. A Metro'                                | 6b+ |
| 6. Super artur         | 6a | 4. Corto Circuito                          | 6b  |
| 7. ...E bravo Zamba    | 6a | 5. Estote parati                           | 6a+ |
| 8. ?                   | 6a |  |     |
| 9. Olla                | 6a |  |     |
| 10. I Marchi           | 6a |  |     |

## 16.8. Rian Cornei, Ciappo delle Conche



South  
15 m.

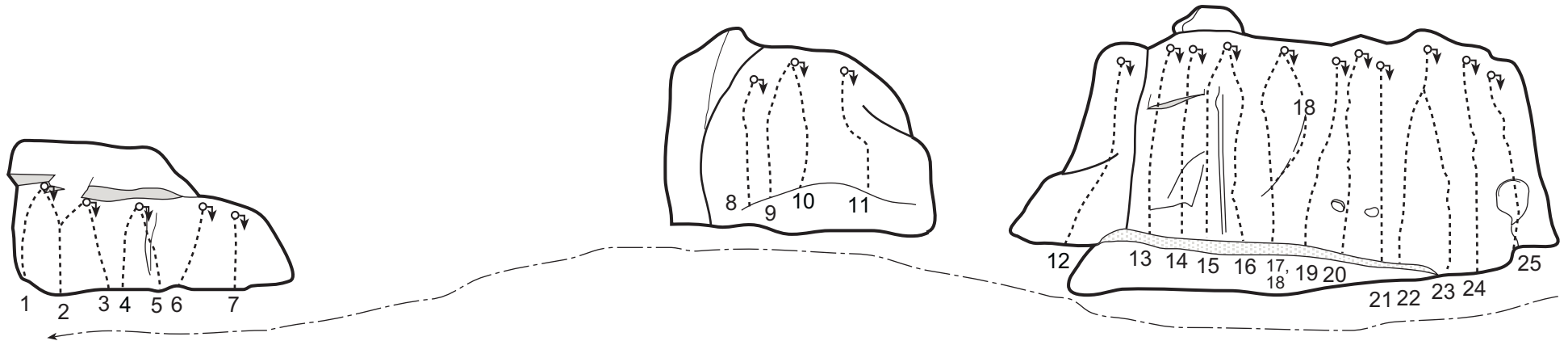

- |                                  |     |                                 |     |
|----------------------------------|-----|---------------------------------|-----|
| 1. Tilita                        | 5b  | 14. I guerrieri dell'arcobaleno | 6a+ |
| 2. Apita o Comboio               | 5c  | 15. Saluti da Muroroa           | 6a  |
| 3. Sopra il tetto c'e' Marchetto | 6a+ | 16. Solitudine                  | 6a+ |
| 4. Der alte barde (Top Rope)     | 6b  | 17. Clitorio                    | 6b  |
| 5. Quellu belin du scupulin      | 6a+ | 18. Silvia                      | 5c  |
| 6. Bonsai                        | 6b  | 19. Sector                      | 5c  |
| 7. Kurz und knachig              | 6c  | 20. Passo Sepozzo               | 6a  |
| 8. Albachiara                    | 6a  | 21. Kindergarten                | 5b  |
| 9. La sparata dei Mortaretti     | 5c  | 22. Ciappo delle conche         | 5b  |
| 10. Alessandra                   | 6a  | 23. Utopia al chiar di Luna     | 6a+ |
| 11. Variegato amarena            | 5c  | 24. Drum Milde                  | 6a+ |
| 12. Rigoletto                    | 6a  | 25. Passo e chiudo              | 5a  |
| 13. Desideri di una Top model    | 5b  |                                 |     |

© coronn.com

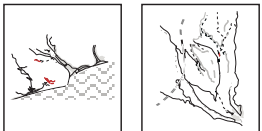

## 16.9. Rian Cornei, Bocca di Bacco

North  
20 m.

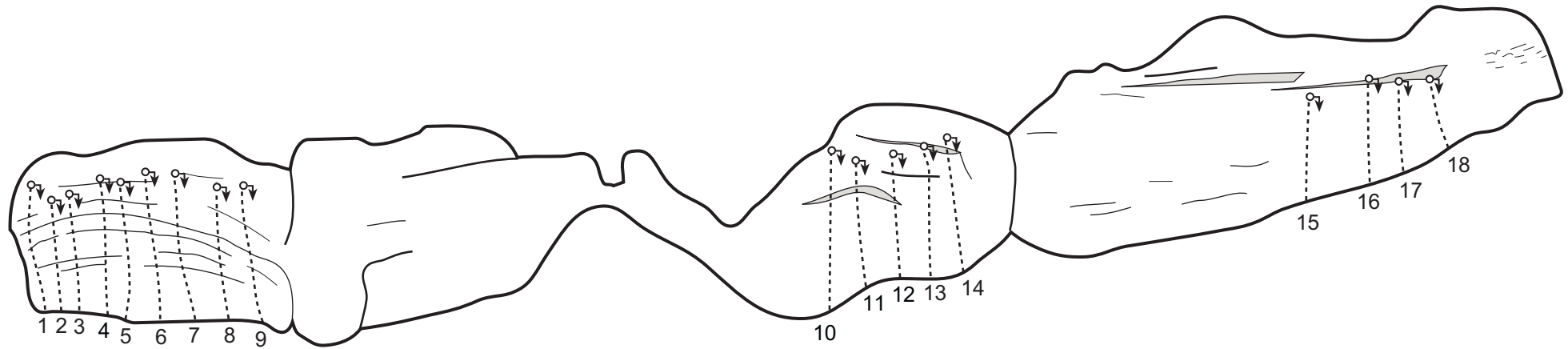

- |                      |     |                                 |     |
|----------------------|-----|---------------------------------|-----|
| 1. Primo incontro    | 6a  | 11. ?                           | 6b+ |
| 2. Amore rubato      | 6a+ | 12. Pensieri proibiti           | 6b+ |
| 3. Antro della Luna  | 6b+ | 13. Obelix                      | 6c  |
| 4. Resinix           | 6b+ | 14. Harrier                     | 6c  |
| 5. A volte ritornano | 6c  | 15. Mattino di primavera        | 6a  |
| 6. Gli spari sopra   | 6b+ | 16. Sogno di una farfalla       | 6b  |
| 7. Ponti di Bactapur | 6b+ | 17. Birdy                       | 6c  |
| 8. Transfert         | 6b+ | 18. Ricordi d'infanzia          | 7a  |
| 9. L'Uomo banale     | 7a  | 19. Facciamo un sacco i diversi | 6c  |
| 10. ?                | 6b+ | 20. Il Gallo non canta piu'     | 6b  |

© coronn.com

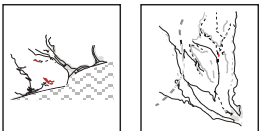

# 16.10. Rian Cornei, Gola dei Briganti

All the points of the compass  
20 m.

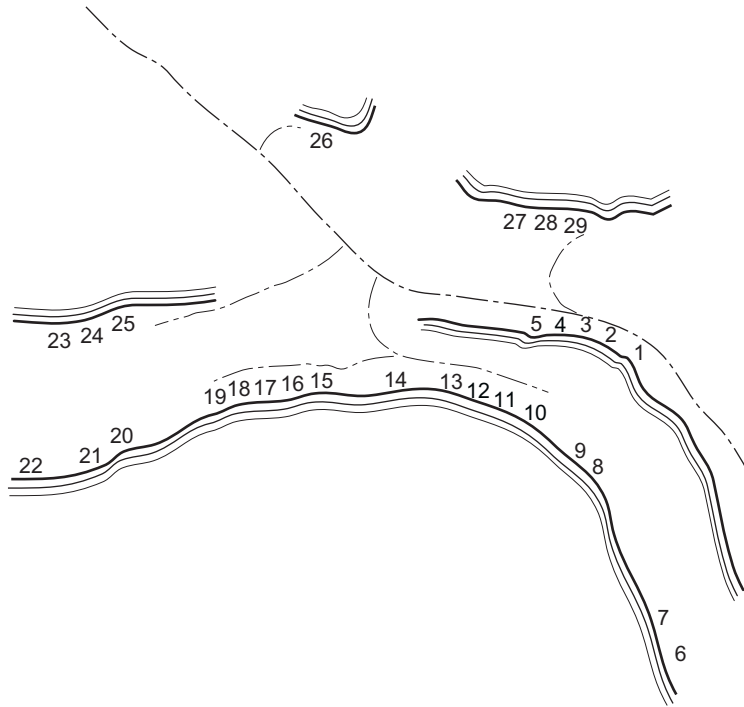
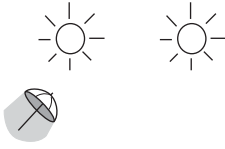

Direction  
Orco

- |                                |     |
|--------------------------------|-----|
| 1. Jamin-A                     | 8a+ |
| 2. Infinita                    | ?   |
| 3. La Rissa                    | 7a+ |
| 4. Racing in the street        | 6b+ |
| 5. Hector                      | 6c+ |
| 6. Mister X                    | 6c  |
| 7. Merci beaucoup nature       | 6b  |
| 8. Notte magica                | 6b+ |
| 9. Incubus                     | 6b  |
| 10. Scherzi del Vino           | 7a  |
| 11. Smemorex                   | 7a  |
| 12. Ciao e scioa               | 6c  |
| 13. Self control               | 6b  |
| 14. Lilliput                   | 6b+ |
| 15. Ronchionata                | 5+  |
| 16. Mister Fantasy             | 6a  |
| 17. Impressioni di Settembre   | 6a  |
| 18. Quin sabe                  | 6a+ |
| 19. Biko                       | 5c  |
| 20. Ultime grida dalla falesia | 6b  |
| 21. Il Fico                    | 6b  |
| 22. Non sei mica King Kong     | 6a  |
| 23. Mister Bluff               | 6a  |
| 24. Fata turchina              | 6b  |
| 25. U fantasma du louvre       | 6b  |
| 26. U sandru                   | 5c  |
| 27. Patto col Diavolo          | 6c  |
| 28. Filtro della strega        | 6b+ |
| 29. Geronimo                   | 5b  |
| 30. ?                          | 7a  |
| 31. Malafemmina                | 7b  |
| 32. Mantide                    | 6c  |
| 33. Virus                      | 6b  |

33  
32  
31  
30

Direction  
Ponte Cornei

© coronn.com

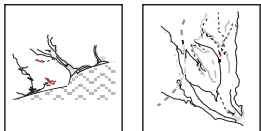

# 16.11.1. Rian Cornei, Falesia del Silenzio



South-West  
30 m.

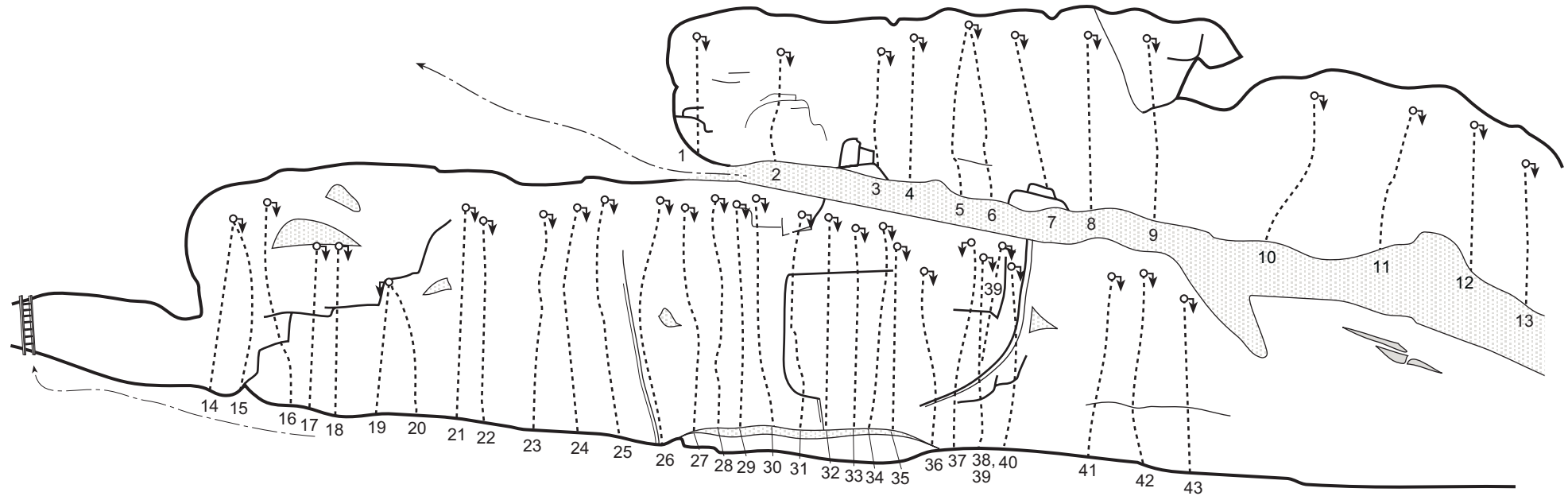

- |                            |     |                              |     |                              |     |
|----------------------------|-----|------------------------------|-----|------------------------------|-----|
| 1. ?                       | 5c  | 14. Dous Dous                | 5c  | 29. Notte delle gomme bucate | 6c  |
| 2. Temple of the King      | 7a  | 15. Falso d'autore           | 6a+ | 30. Bagonghi                 | 6c+ |
| 3. Il ritorno degli storti | 6a+ | 16. Patek                    | 6a+ | 31. Alicante                 | 6b  |
| 4. Amazonia                | 6a  | 17. Telefona                 | 6a+ | 32. Monregalesi al Rhum      | 7b  |
| 5. Pizza Wurstel           | 6a+ | 18. Il silenzio parla        | 6a+ | 33. Schiavi ma distinti      | 7a  |
| 6. La Gatta Soraya         | 6b  | 19. Solotrip                 | 6a+ | 34. Te gusta l'aragosta      | 6c+ |
| 7. Greenpeace              | 6b  | 20. Stiletto                 | 5c  | 35. Il silenzio e' d'oro     | 7a  |
| 8. Ecologia                | 5c  | 21. Pat Pong                 | 6a  | 36. Siddharta                | 7a+ |
| 9. Beer&Chips              | 6b+ | 22. Il ritorno dalle polvere | 6b  | 37. Avaria                   | 7b  |
| 10. A Bastone              | 5b  | 23. Antaio                   | 6a  | 38. Pas de bloc              | 7c  |
| 11. L'acrobata dei Boschi  | 5c  | 24. La Cicciolina            | 6b+ | 39. Franti                   | 7b+ |
| 12. Yuma                   | 6b+ | 25. Fjodor                   | 6a+ | 40. L'Avvocato               | 7a  |
| 13. Saxonia                | 5c  | 26. Viaggio nella conoscenza | 6a+ | 41. Ciccia baliccia          | 6b  |
|                            |     | 27. Golden Lady              | 6b+ | 42. Riti magici al tramonto  | 6b+ |
|                            |     | 28. Joe Rotella              | 7a+ | 43. L'Urlo della farfalla    | 6b  |

© coronn.com

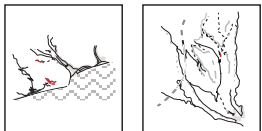



## 16.11.2. Rian Cornei, Striature Obese



South, South-West  
35 m. Multi Pitch up to 50 m.

- |   |         |
|---|---------|
| 44. Ricardo di max                      | 6c,6a   |
| 45. Braille                             | 7c+     |
| 46. Al malu'                            | 7c,7b+  |
| 47. Al Borgo c'e' u Guru                | 6b+,6a+ |
| 48. Cervello rotante                    | 6a+     |
| 49. Un bel regalo per il mio compleanno | 6a+     |
| 50. Las Vegas                           | 6a+     |

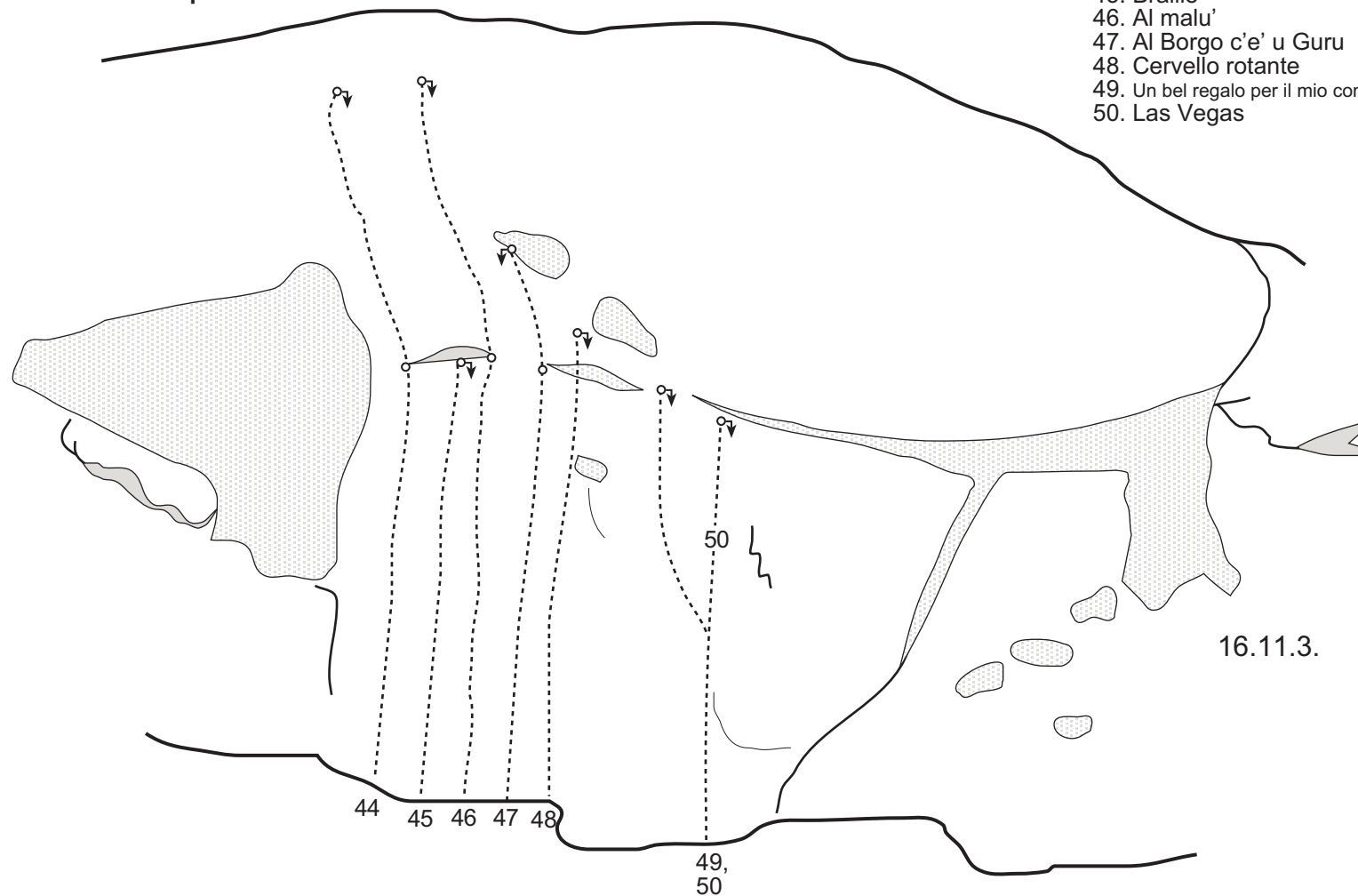

16.11.3.

© coronn.com

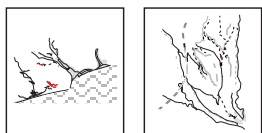

# 16.11.3. Rian Cornei, Tempio del Vento



South  
30 m.

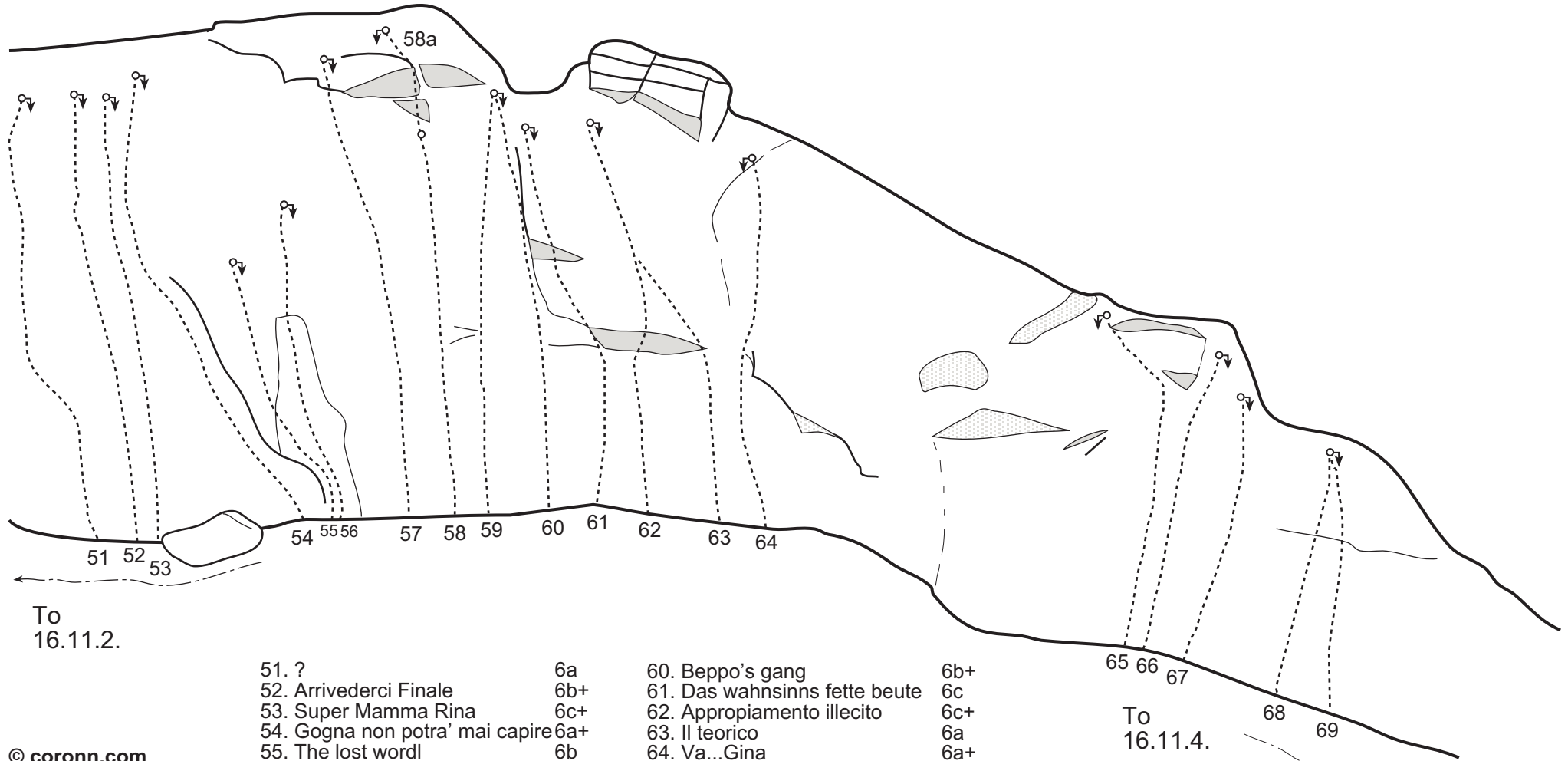

- |                                 |     |                               |     |
|---------------------------------|-----|-------------------------------|-----|
| 51. ?                           | 6a  | 60. Beppo's gang              | 6b+ |
| 52. Arrivederci Finale          | 6b+ | 61. Das wahnsinns fette beute | 6c  |
| 53. Super Mamma Rina            | 6c+ | 62. Appropriamento illecito   | 6c+ |
| 54. Gogna non potra' mai capire | 6a+ | 63. Il teorico                | 6a  |
| 55. The lost word!              | 6b  | 64. Va...Gina                 | 6a+ |
| 56. Full Moon                   | 6b  | 65. Suini volanti             | 6b+ |
| 57. Roba da Matti               | 6b  | 66. Non staccatemi il fungo   | 6a  |
| 58. Panare volanti              | 6a+ | 67. Dove osano le oche        | 6a  |
| 58a. Frau Einzhan und Herr      | 6b  | 68. M'Impicco il Pacco        | 6b  |
| 59. Cosa che'                   | 5c  | 69. Eccheneso'                | 6b  |

© coronn.com

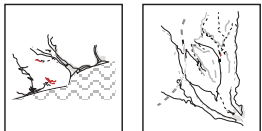

# 16.11.4. Rian Cornei, Tempio del Vento



South  
20 m.

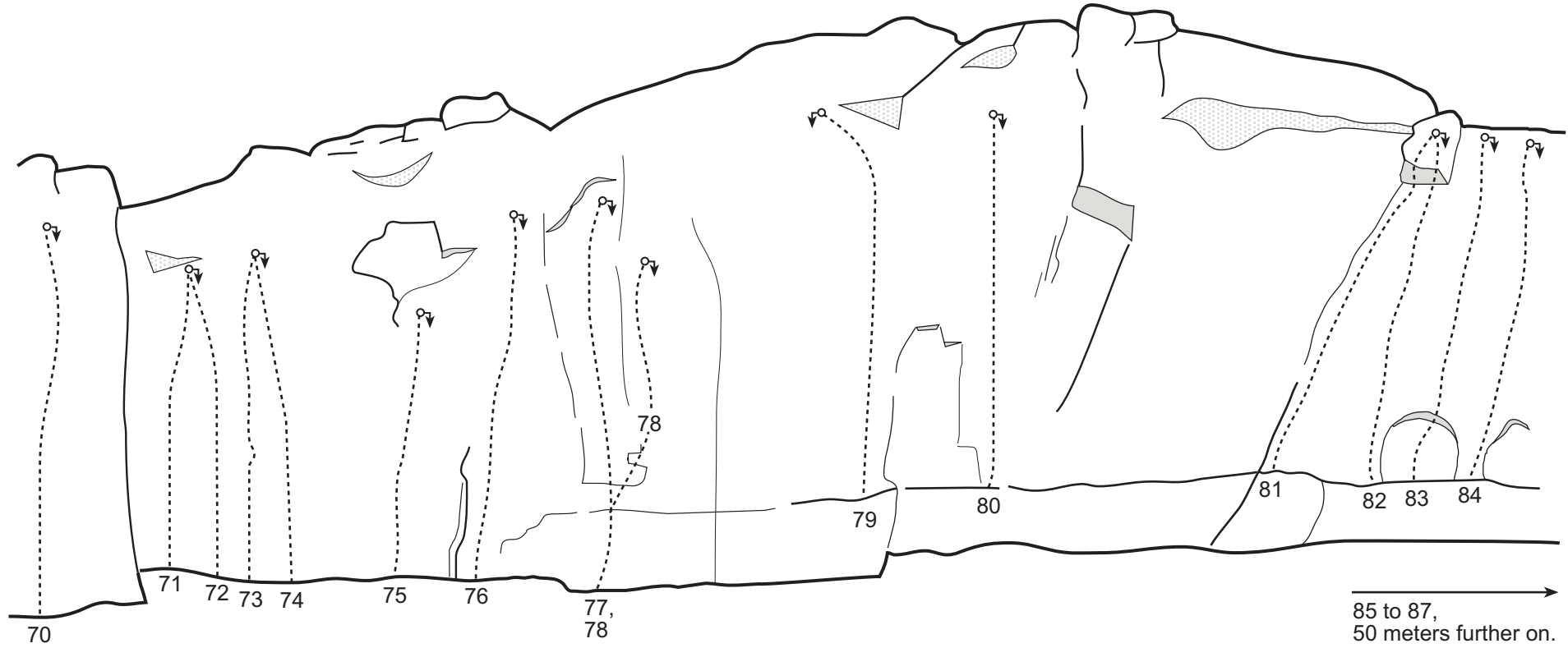

- |                                   |     |                                  |     |
|-----------------------------------|-----|----------------------------------|-----|
| 70. Via di Marco e Riccardo       | 5b  | 79. Morbida Sarucia              | 6c  |
| 71. Rispetto la natura            | 5c  | 80. ?                            | 6b+ |
| 72. Dubbi di Bacco                | 6b+ | 81. Accendi un cero Andrea       | 6a  |
| 73. Video Game                    | 7b+ | 82. Schwanker                    | 6c+ |
| 74. Ma bravo Guaglione            | 6c+ | 83. Cape Town                    | 7a+ |
| 75. Tra le braccia di Morfeo      | 6a  | 84. Dammi la mano destro belinda | 7a  |
| 76. Tempio del vento              | 6b  | 85. Spiderman                    | 6b+ |
| 77. Un Gniff Gnaff melodrammatico | 6b+ | 86. Es ruteli fur di             | 6b  |
| 78. Orrenda                       | 6b+ | 87. Faregschaderli               | 6b+ |

© coronn.com

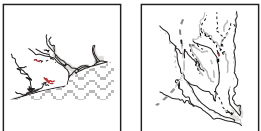

# 16.12. Val di Nava, Il Vascello and Estathe

N 44° 12.536'  
EO 08° 21.006'

East  
20 m.

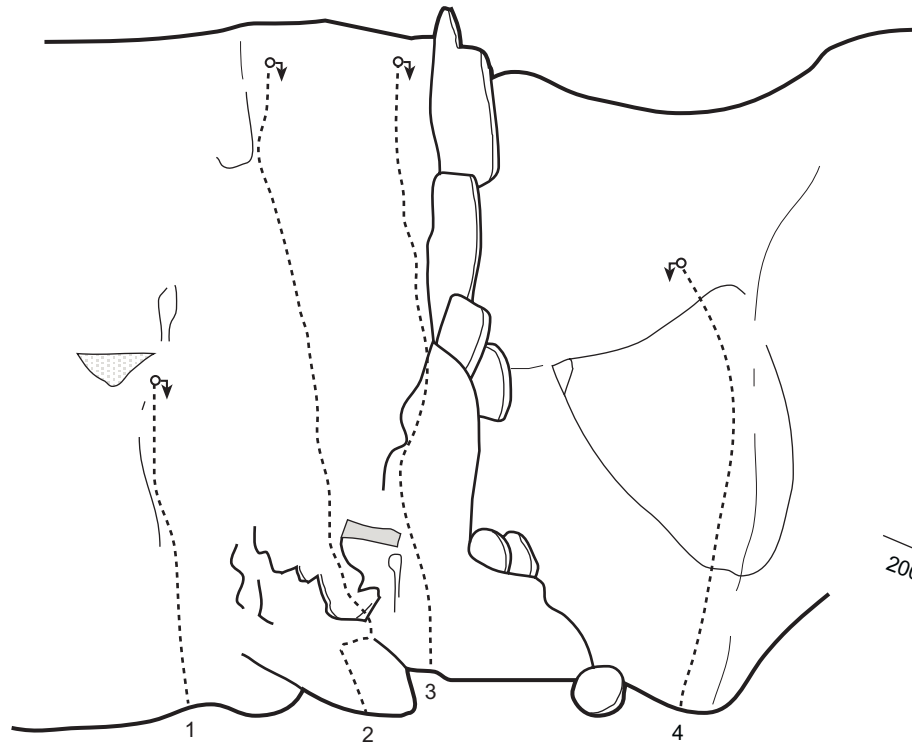
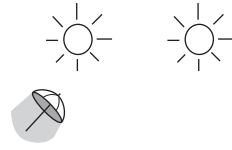

- |                     |     |
|---------------------|-----|
| 1. Dada             | 6b  |
| 2. Furore           | ?   |
| 3. Dead can dance   | 7a+ |
| 4. Running on empty | 6a  |

© coronn.com

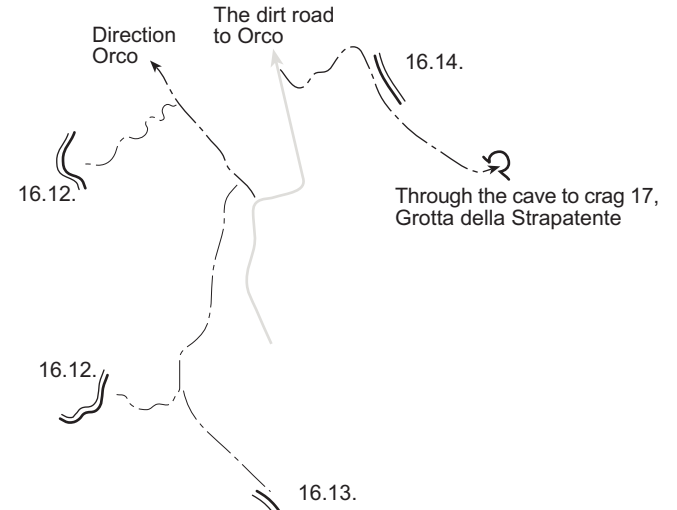
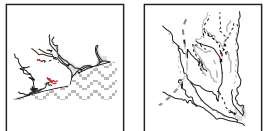

200 m. right

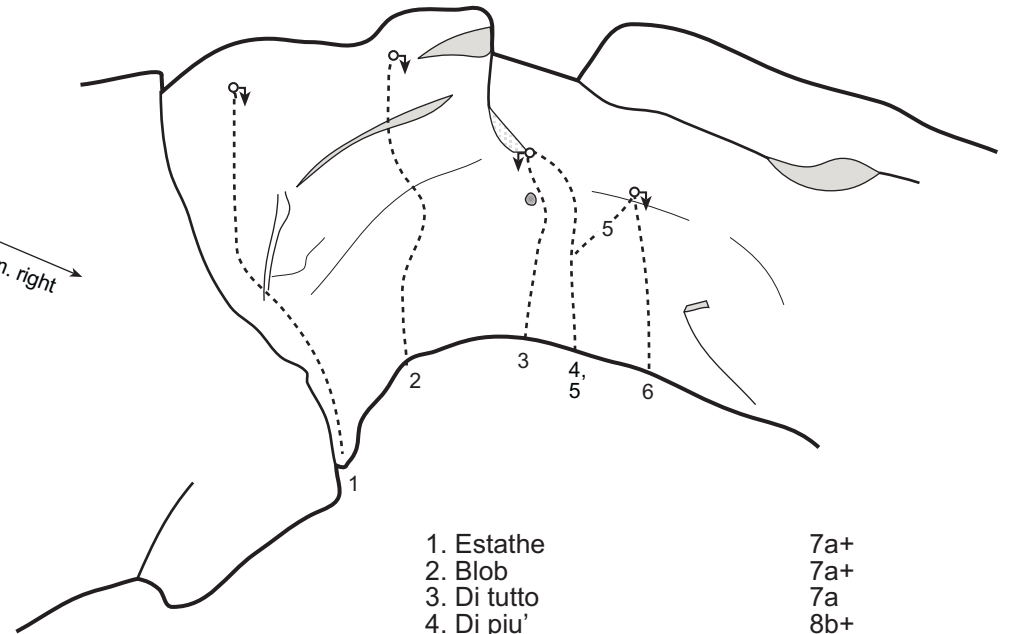

- |                 |     |
|-----------------|-----|
| 1. Estathe      | 7a+ |
| 2. Blob         | 7a+ |
| 3. Di tutto     | 7a  |
| 4. Di piu'      | 8b+ |
| 5. Medi trani   | ?   |
| 6. Mediterranea | 7b+ |

# 16.13. Val di Nava, Grotta dei Pipistrelli

North  
15 m.

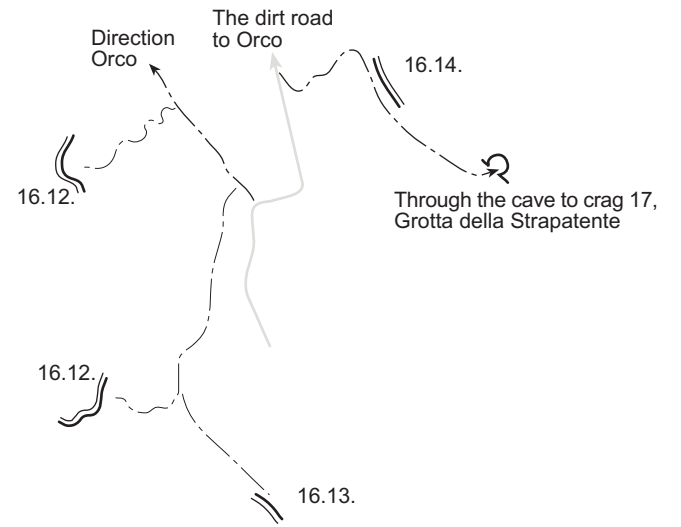
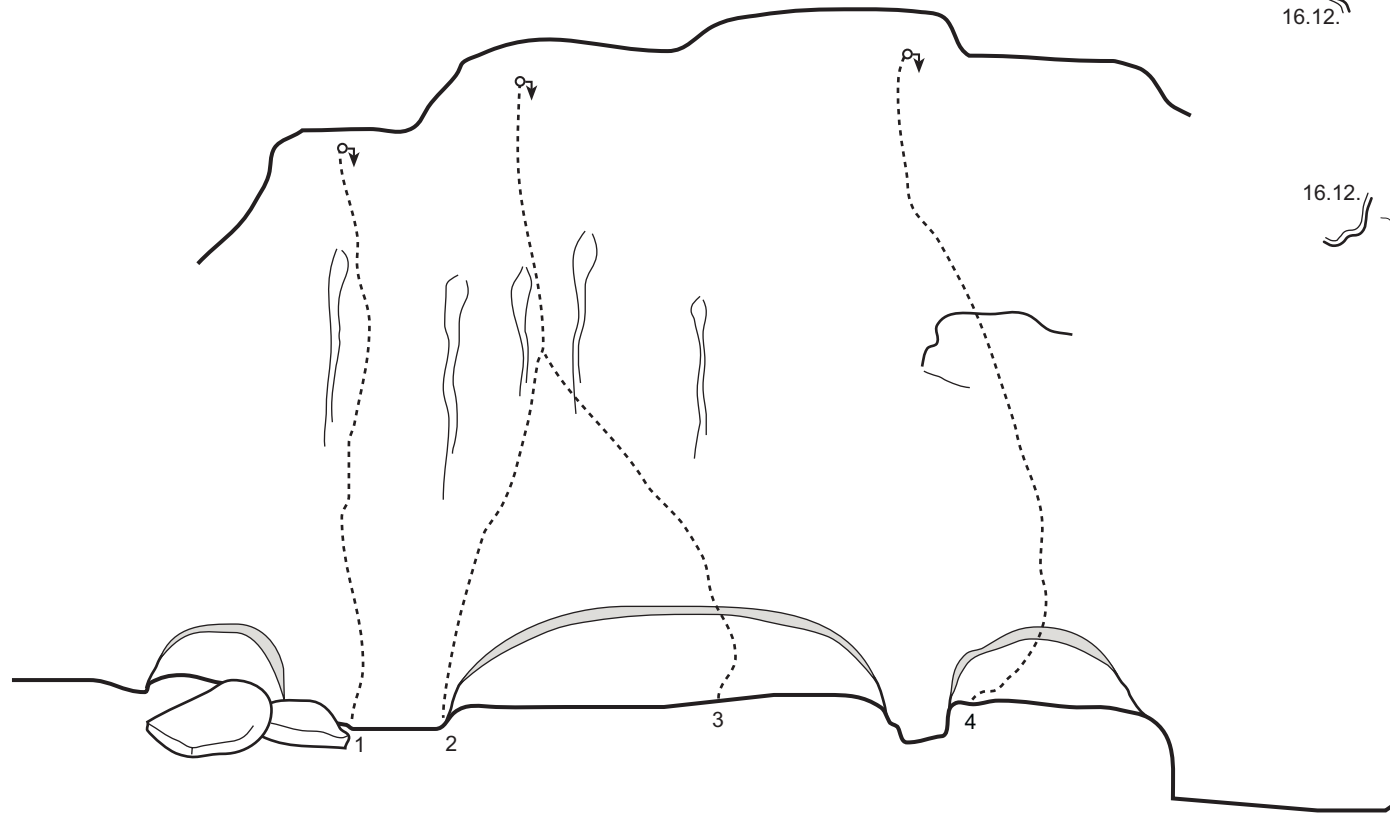

- |                 |     |
|-----------------|-----|
| 1. Crach        | 7c  |
| 2. Mago         | 7c  |
| 3. Relax        | ?   |
| 4. Le ore liete | 7b+ |

© coronn.com

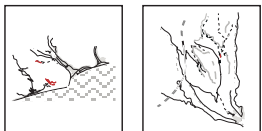

# 16.14. Val di Nava, Grotta dei Balconi

N 44° 12.637'  
EO 08° 20.961'

South  
20 m.

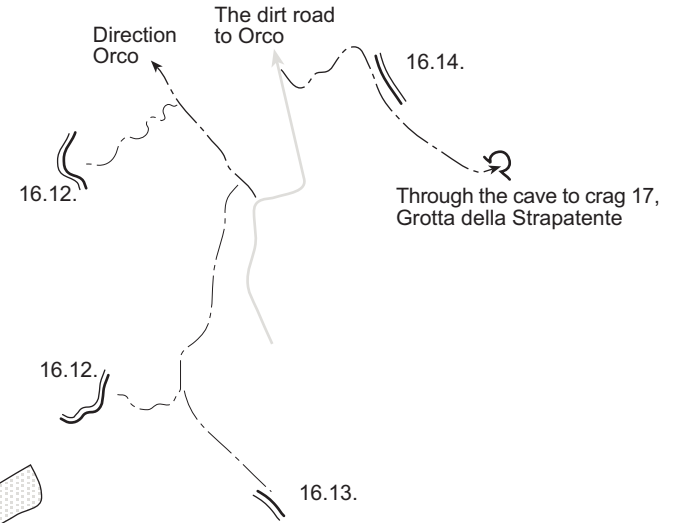
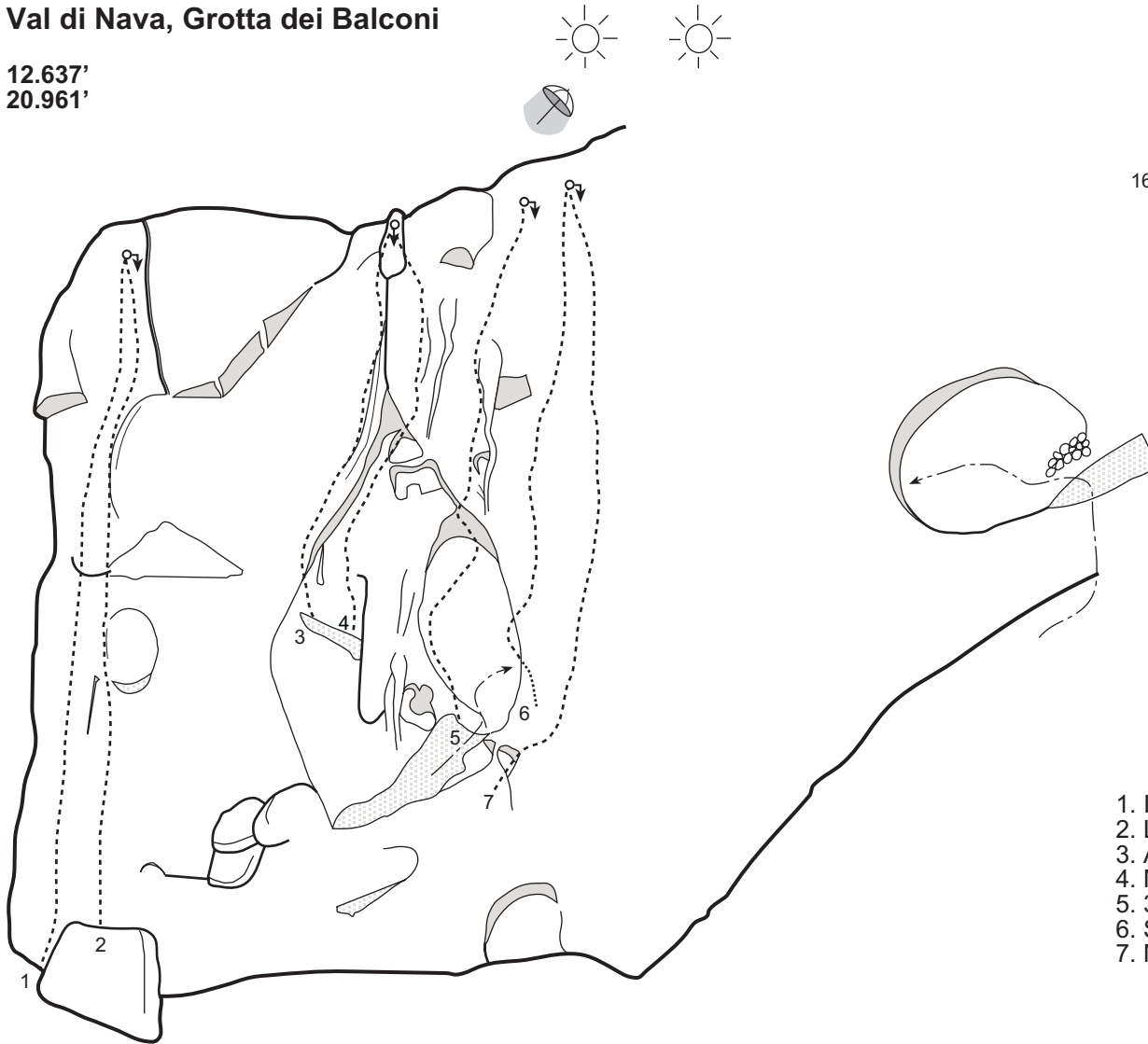

- |                            |     |
|----------------------------|-----|
| 1. I Bacchanali di Augusto | 6c  |
| 2. Le orge di Caligola     | 7a  |
| 3. Agnus Dei               | 6a+ |
| 4. Messalina               | 7a  |
| 5. 30.000 spit A.C.        | 7b  |
| 6. Spartacus               | 7a  |
| 7. Megalitica              | 6c  |

© coronn.com

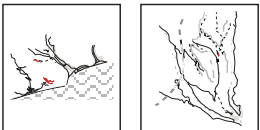

# 17. Bastionata di Boragni, Key-map

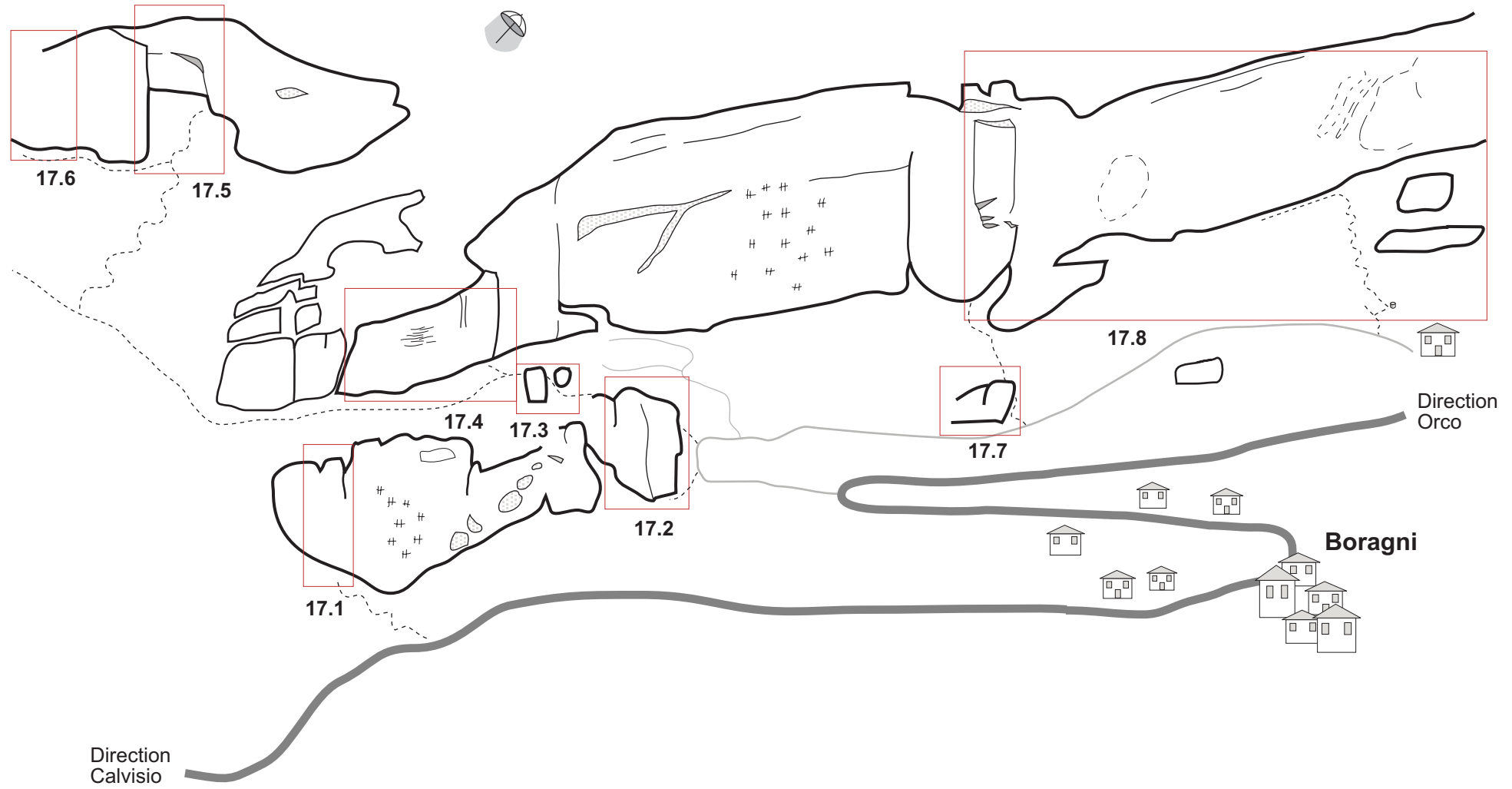
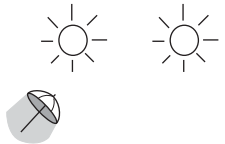

## 17.1. Bastionata di Boragni, Avancorpo

N 44° 12.778'  
EO 08° 21.124'

North  
40 m.

- |                             |        |
|-----------------------------|--------|
| 1. Chi non vola e' un vile  | 6a,6a+ |
| 2. Brodo di Calzini         | 5c,6a+ |
| 3. Chi vola vale            | 6a+    |
| 4. Another spit in the wall | 6a+    |

### How to find the crag:

To find the area, see the Keymap.  
Coming from Calvisio; About 1 km before  
the small village Boragni the road passes  
just besides a crag. Park at a lay-by and  
follow the track for a couple of minutes to  
find this crag. The crag is visual from the  
road and from the lay-by.

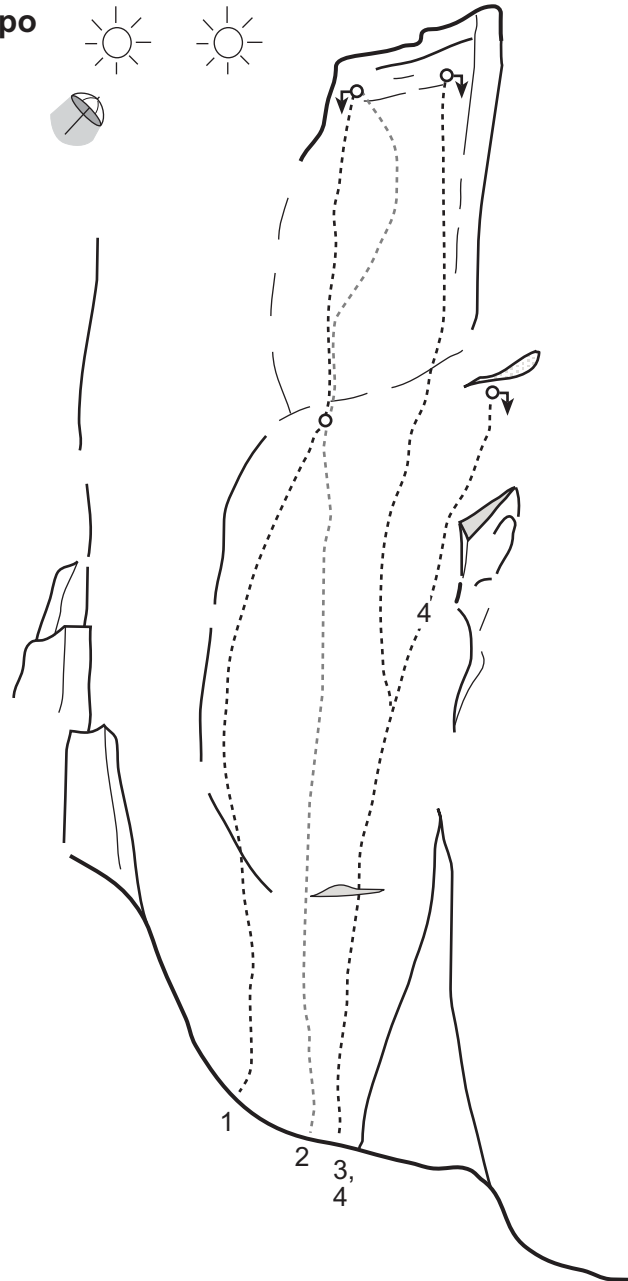

© coronn.com

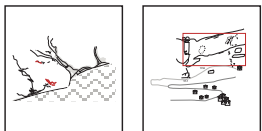



## 17.2.0. Bastionata di Boragni, Il Pilastro

N 44° 12.848'  
EO 08° 21.014'

North, Northwest  
30 m.

- |                           |        |
|---------------------------|--------|
| 1. Tris                   | 5c     |
| 2. Eclipse                | 7a     |
| 3. Aldebaran              | 7a     |
| 4. Ci giova               | 7a     |
| 5. Thovax                 | 6a+    |
| 6. Plexus                 | 6b     |
| 7. Stati di allucinazione | 6c+,6b |
| 8. Black out              | 6c+    |
| 9. Corda senz'anima       | 6b+    |
| 10. Carletto's way        | 6a+    |
| 11. Super Gasp            | 7b     |
| 12. Budget for fischer    | 7a+    |
| 13. Intime delizie        | 6c+    |

### How to find the crag:

To find the area, see the Key-map.  
Coming from Calvisio; Pass the small village Boragni and park in the first hairpin bend. Walk 25 meters on the gravelled road to reach the crag.

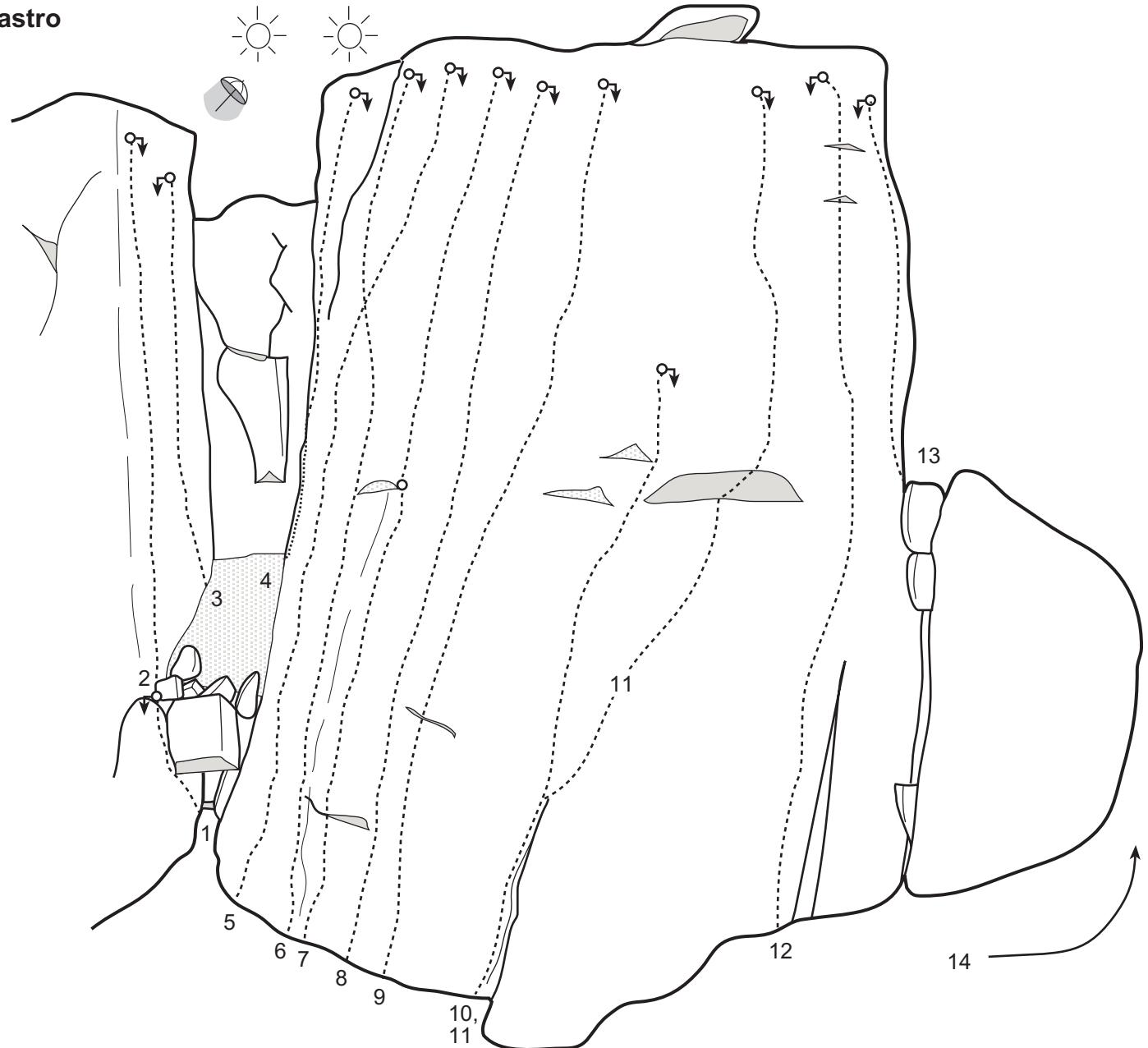

© coronn.com

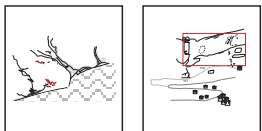

# 17.2.1. Bastionata di Boragni, Il Pilastro

West  
20 m.

- |                               |     |
|-------------------------------|-----|
| 14. Tappo di Ghisa (top rope) | 6b+ |
| 15. Duca di Trolla (top rope) | 6b+ |
| 16. Schnepfentod (top rope)   | 5b  |
| 17. Jugo Express (top rope)   | 5c  |
| 18. Ragni? Bo'!               | 6b  |
| 19. Good morning              | 6b+ |
| 20. By pass                   | 6c  |
| 21. Delirium Tremens          | 6b+ |
| 22. Il ritorno di Andreix     | ?   |
| 23. Ali' Baba'                | ?   |

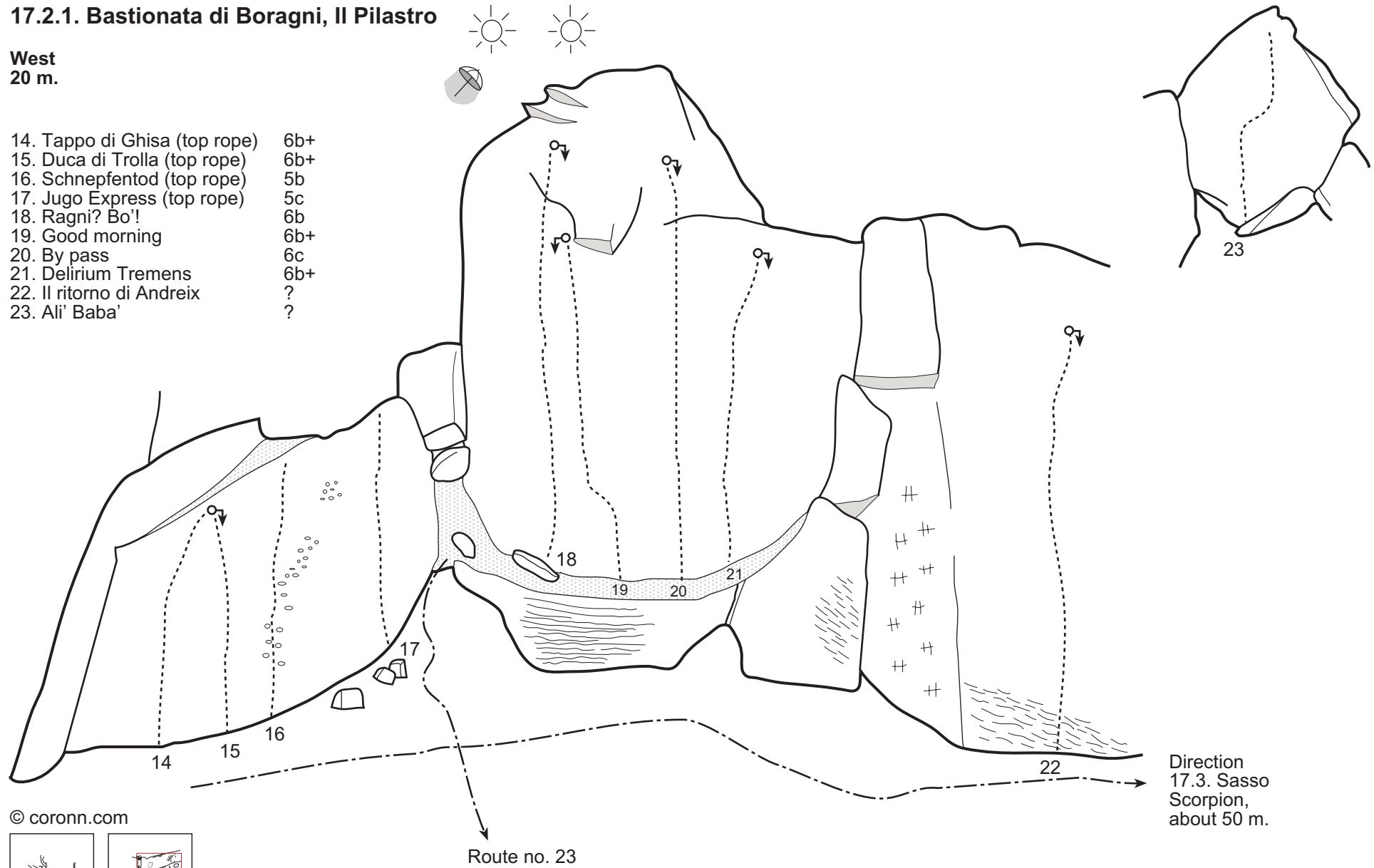

© coronn.com

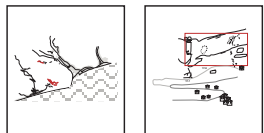

Direction  
17.3. Sasso  
Scorpion,  
about 50 m.

### 17.3. Bastionata di Boragni, Sasso Scorpio

West and East  
15 m.

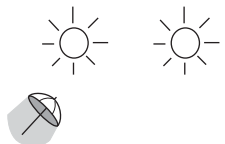
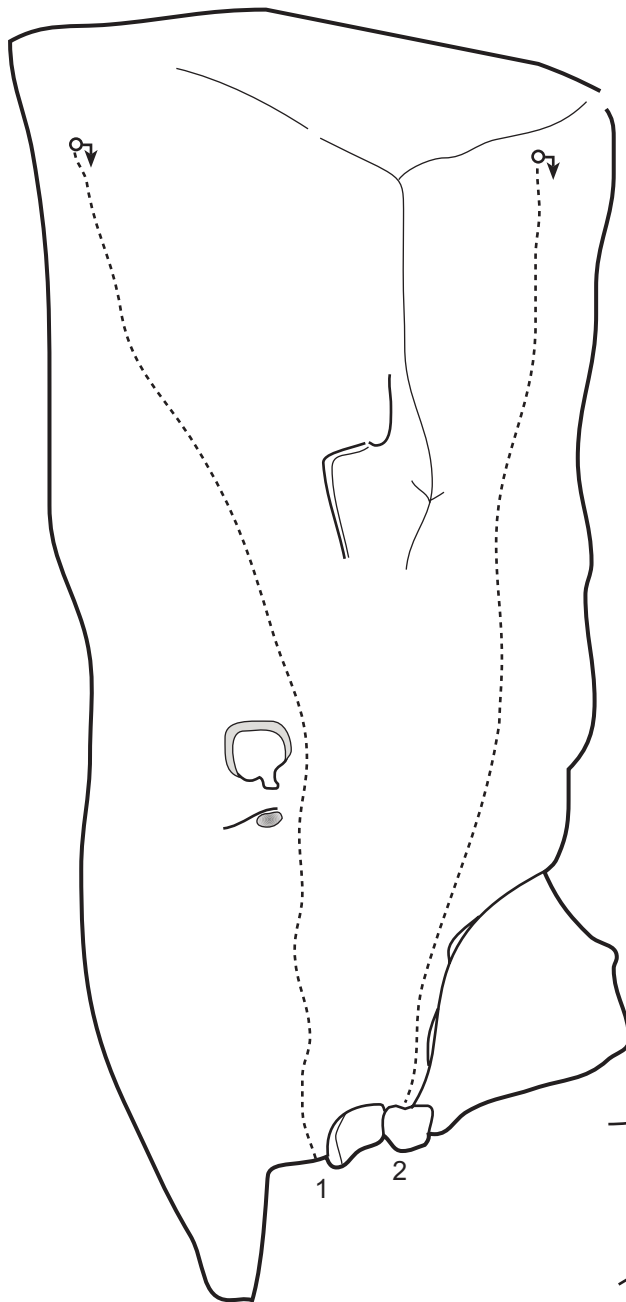

- 1. Asgard
- 2. Scorpion
- 3. Mi manda Jessica
- 4. Super Lollo&Marco

7a+  
7c  
6a  
6a+

Direction  
17.4. Settore  
Sinistra,  
about 50 m.

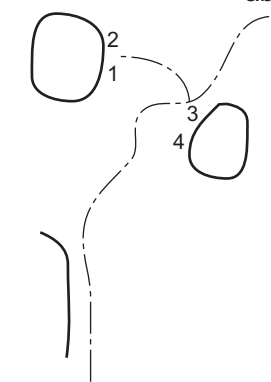

Direction  
17.2. Il Pilastro  
about 50 m.

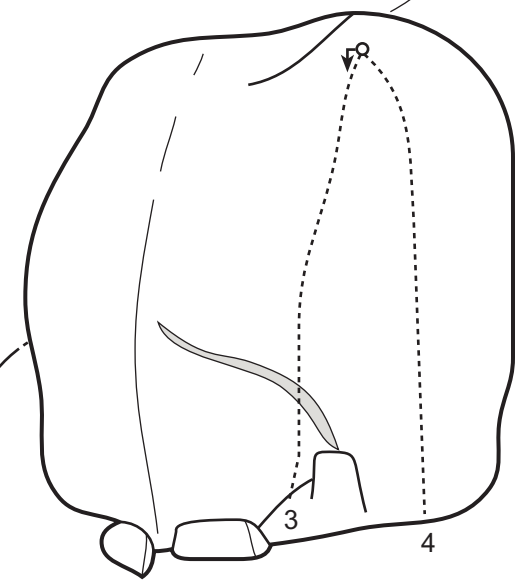

© coronn.com

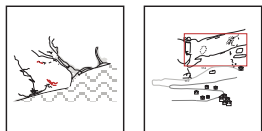

# 17.4.0. Bastionata di Boragni, Settore Sinistra (Left sector)

East  
40 m. Multi pitch 50 m.

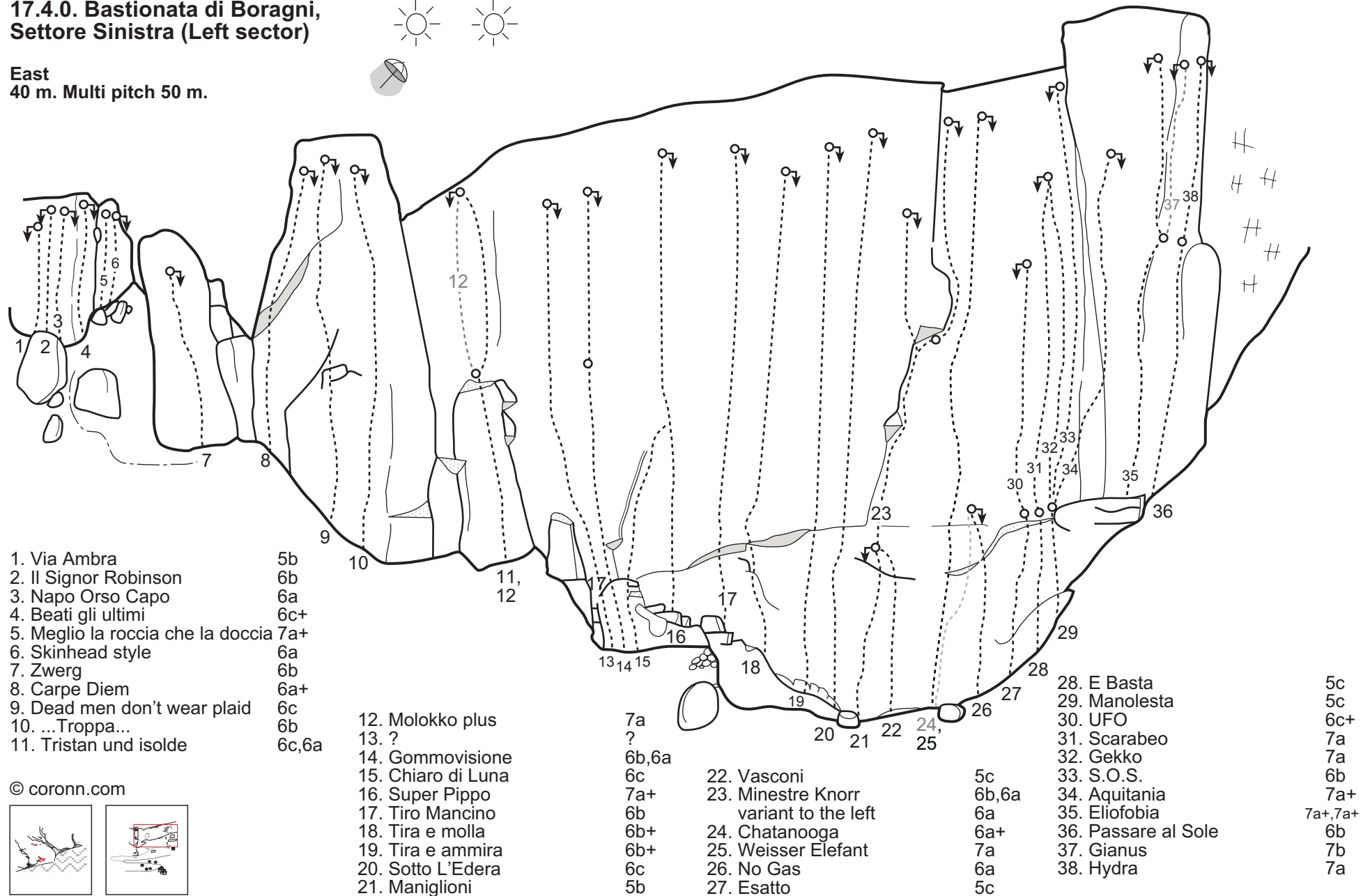
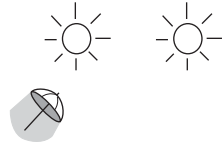

- 1. Via Ambra
- 2. Il Signor Robinson
- 3. Napo Orso Capo
- 4. Beati gli ultimi
- 5. Meglio la roccia che la doccia
- 6. Skinhead style
- 7. Zwerg
- 8. Carpe Diem
- 9. Dead men don't wear plaid
- 10. ...Troppa...
- 11. Tristan und isolde

- 5b
- 6b
- 6a
- 6c+
- 7a+
- 6a
- 6b
- 6a+
- 6c
- 6b
- 6c,6a

- 12. Molokko plus
- 13. ?
- 14. Gommovisione
- 15. Chiaro di Luna
- 16. Super Pippo
- 17. Tiro Mancino
- 18. Tira e molla
- 19. Tira e ammira
- 20. Sotto L'Edera
- 21. Maniglion

- 7a
- ?
- 6b,6a
- 7a+
- 6b
- 6b+
- 6b+
- 6c
- 5b

- 22. Vasconi
- 23. Minestre Knorr  
variant to the left
- 24. Chatanooga
- 25. Weisser Elefant
- 26. No Gas
- 27. Esatto

- 5c
- 6b,6a
- 6a
- 6a+
- 7a
- 6a
- 5c

- 28. E Basta
- 29. Manolestia
- 30. UFO
- 31. Scarabeo
- 32. Gekko
- 33. S.O.S.
- 34. Aquitania
- 35. Eliofofia
- 36. Passare al Sole
- 37. Gianus
- 38. Hydra

- 5c
- 5c
- 6c+
- 7a
- 7a
- 6b
- 7a+
- 7a+,7a+
- 6b
- 7b
- 7a

© coronn.com

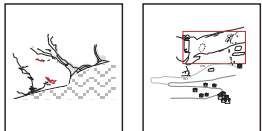

# 17.4.1. Bastionata di Boragni, Settore Sinistro (Left sector)

East  
30 m.

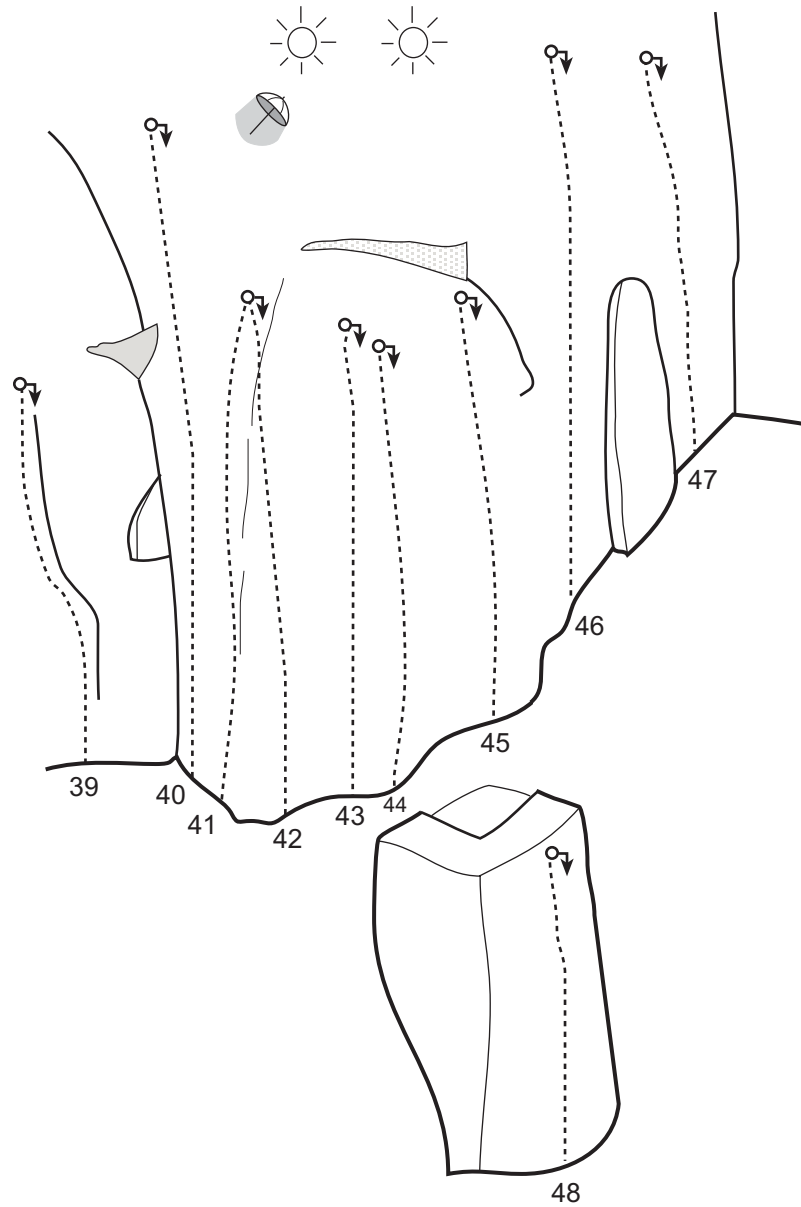

- |                             |     |
|-----------------------------|-----|
| 39. L'Acchiappabuchi        | 6c  |
| 40. Genesi                  | 7a  |
| 41. Gocce di stress         | 6b+ |
| 42. Mon Bijoux              | 6c+ |
| 43. R4 All' avventura       | 7a+ |
| 44. El Capitan Findus       | 6c  |
| 45. Ex-Spinosa              | 6c+ |
| 46. La strada per l'inferno | 7a+ |
| 47. Un giorno in Paradiso   | 7b  |
| 48. Myricae                 | 6b+ |

© coronn.com

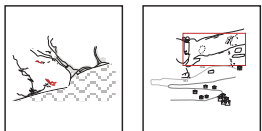

# 17.5. Bastionata di Boragni, Grotta della Strapatente

N 44° 12.719'  
EO 08° 21.009'

Northwest  
30 m.

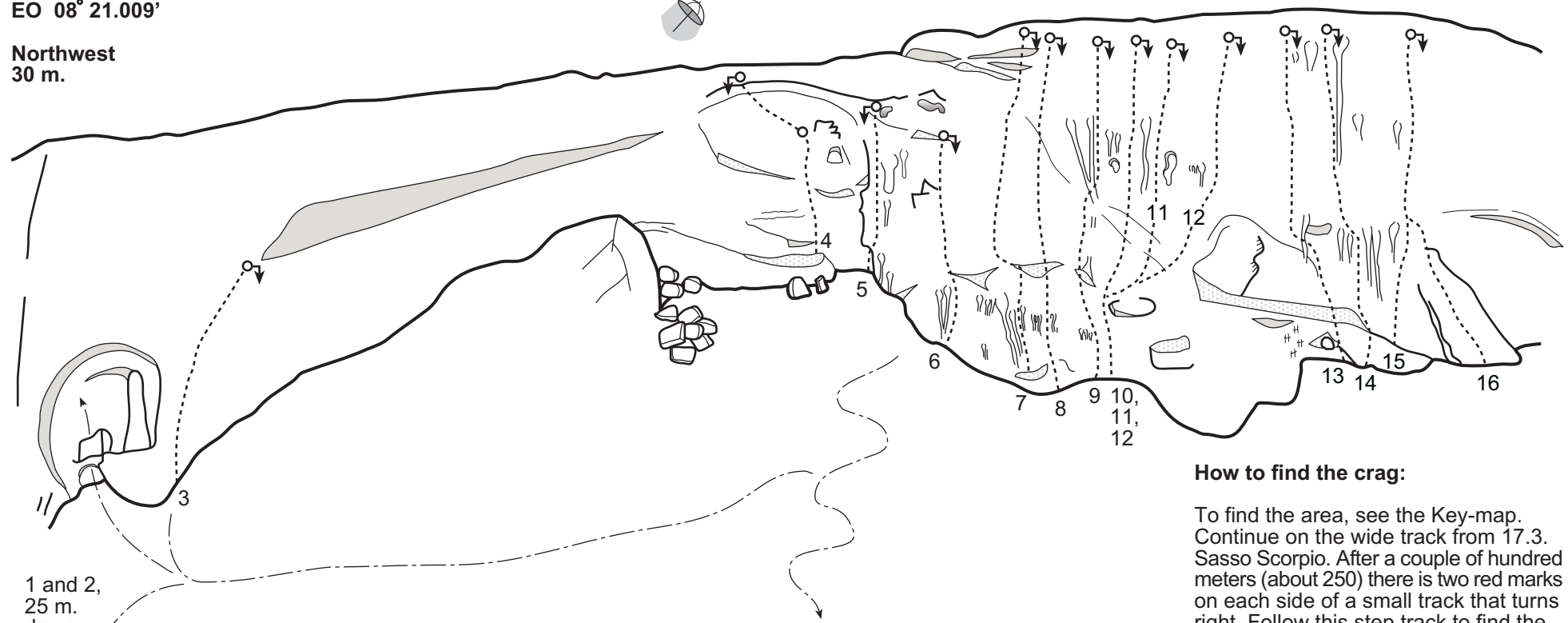
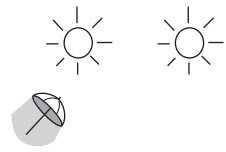

1 and 2,  
25 m.  
down.

Direction  
17.6.  
about 100 m.

- |                           |     |                   |     |
|---------------------------|-----|-------------------|-----|
| 1. Strapatente (no Topos) | 5b  | 9. Sonica         | 6c  |
| 2. Nautilus(no Topos)     | 7b+ | 10. Memobox       | 7b  |
| 3. ?                      | ?   | 11. Panorama      | 7a+ |
| 4. En Attendant Berhaut   | ?   | 12. Filikudi      | 7a  |
| 5. A life less ordinary   | 6c+ | 13. Pyro          | 7a+ |
| 6. Lick my wounds         | 6c+ | 14. Stella Cometa | 7a  |
| 7. Semplicemente          | 7a  | 15. Web           | 7a+ |
| 8. Texaco                 | 7b  | 16. Blu           | 6c  |

### How to find the crag:

To find the area, see the Key-map. Continue on the wide track from 17.3. Sasso Scorpio. After a couple of hundred meters (about 250) there is two red marks on each side of a small track that turns right. Follow this step track to find the crag. Access; About 15 minutes from Sasso Scorpio. Walk through the cave to reach the sector 16!

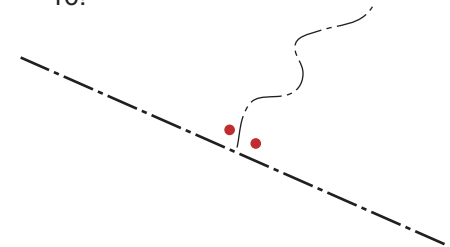

© coronn.com

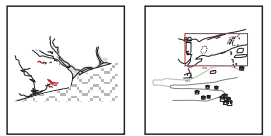

# 17.6. Bastionata di Boragni, Grotta della Strapatente, Left part

N 44° 12.672'  
EO 08° 21.028'

West  
30 m.



© coronn.com

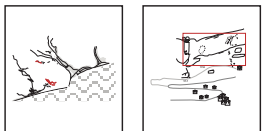

- |                         |     |                           |     |
|-------------------------|-----|---------------------------|-----|
| 1. Pro-Tetto            | 6b+ | 7. Tri-Tetto              | 6b+ |
| 2. Placcato oro         | 4c  | 8. Il regalo dei cugini   | 6b+ |
| 3. Buon compleanno      | 4c  | 9. Pena capitale          | 6a+ |
| 4. Placca dei muratori  | 5b  | 10. Movimenti intestinali | 6a  |
| 5. Dove osano i conigli | 6b  | 11. Biro Bic              | 6b  |
| 6. Lavori forzati       | 6a+ | 12. Kick                  | 7a  |

Direction  
17.5. Grotta della  
Strapatente  
about 100 m.

# 17.7. Bastionata di Boragni, Crazy brothers

N 44° 12.906'  
EO 08° 20.989'

All points of the compass  
20 m.

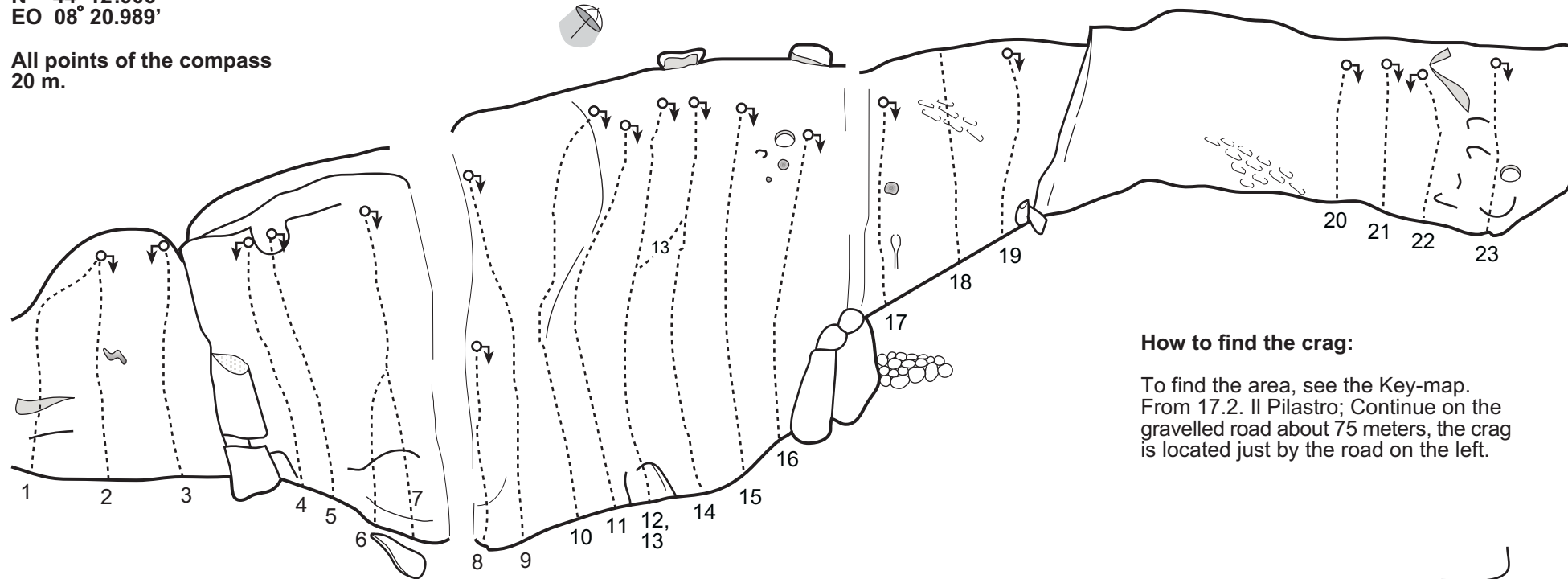
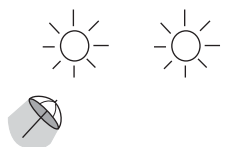

### How to find the crag:

To find the area, see the Key-map.  
From 17.2. Il Pilastro; Continue on the  
gravelled road about 75 meters, the crag  
is located just by the road on the left.

- |                   |     |                             |     |
|-------------------|-----|-----------------------------|-----|
| 1. Fabio          | 6a  | 12. Topomix colpisce ancora | 7c+ |
| 2. Mirko          | 6b  | 13. Crazy mix               | 8a  |
| 3. Alice          | 4b  | 14. Crazy brothers          | 7c  |
| 4. Gnagnu         | 5b  | 15. Senza Tabu'             | 7c  |
| 5. Nanetta        | 6a  | 16. Deficit                 | 6c+ |
| 6. Leo            | 6a+ | 17. Non vedo                | 7c  |
| 7. OK. Britta     | 6b+ | 18. Non sento               | 7b  |
| 8. Uno momento    | 6c+ | 19. Non salgo               | 7b  |
| 9. Il Signor Buck | 7b  | 20. Vedo                    | 6a+ |
| 10. Futur shock   | 7b  | 21. Sento                   | 6a+ |
| 11. Till          | 7a+ | 22. Salgo                   | 5b  |
|                   |     | 23. Ciao                    | 6a+ |

© coronn.com

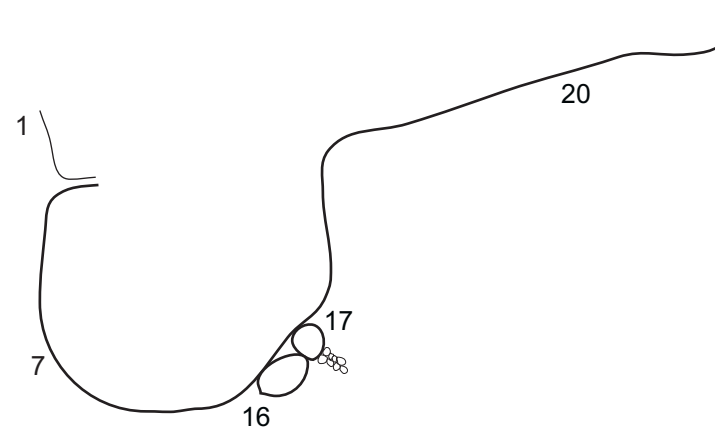
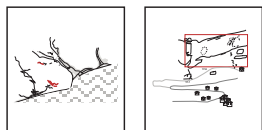



# 17.8. Bastionata di Boragni, Settore Centrale and Settore Destra

N 44° 12.915'  
EO 08° 20.803' (Route 16)

East  
30 m. ! Route 18,19 and 20, 60 m !! Multi pitch up to 110 m.

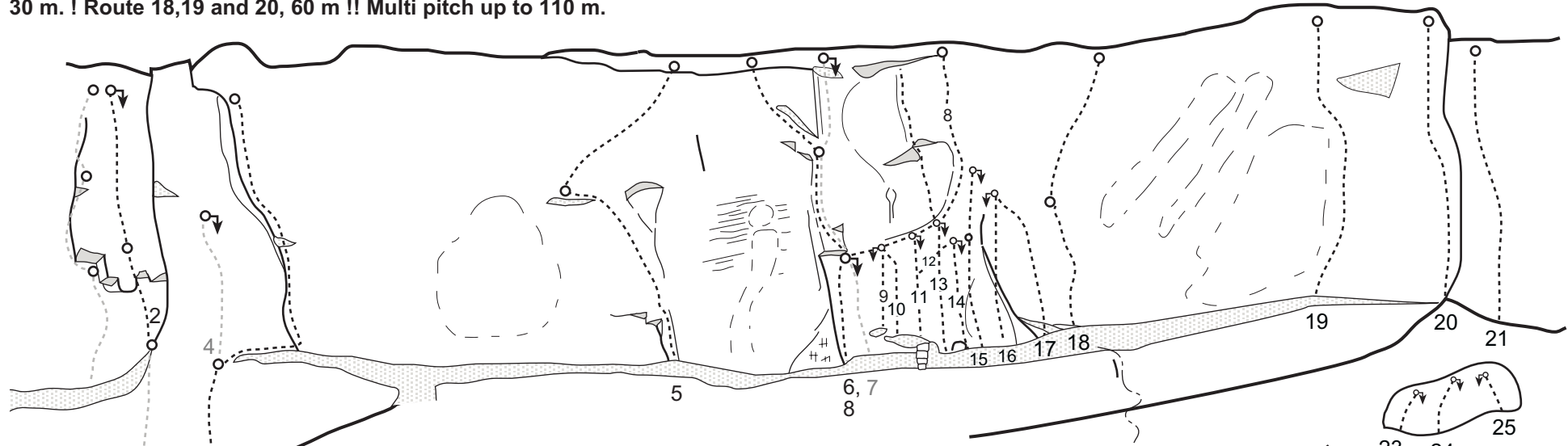
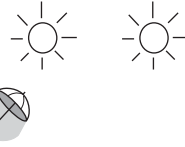

- |                       |            |                        |         |
|-----------------------|------------|------------------------|---------|
| 1. Pipino             | 3,4c,6a,5b | 14. Chiuso per Ferie   | 7a+     |
| 2. Barracuda          | 7a,6c      | 15. Nicolo' delle rose | 6c+,7b+ |
| 3. La Quercia         | 5/A1       | 16. Sinfonia Grigia    | 7b      |
| 4. A foua du bestentu | 7a+        | 17. Incubi di Pietra   | 6c      |
| 5. L'interrogativo    | 6a/A1      | 18. Clessalibur        | 6b,6a   |
| 6. Rocky I            | 6a,4+,5c   | 19. S. Silvestro       | 5/A1    |
| 7. Breathless         | 6c,7a      | 20. Rocky II           | 5c      |
| 8. Rocky IV           | 5c/A1      | 21. Rocky III          | 5c      |
| 9. Croi               | 6b+        | 22. Dune               | 6b      |
| 10. Alcolica          | 7b         | 23. Pagoda             | 6c      |
| 11. Hacida            | 7c+        | 24. Antigallo          | ?       |
| 12. Tripudio          | 7c+        | 25. Agonia             | ?       |
| 13. Anime Dannate     | 7c+,?      |                        |         |

Direction  
17.7. Crazy  
brothers  
about 75 m.

© coronn.com

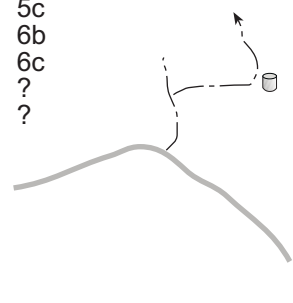
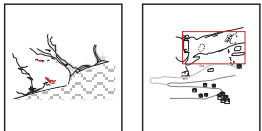

### How to find the crag:

For routes from 5 to 18;  
Continue on the  
gravelled road from  
Crazy brothers. Before  
the house, turn left on  
the small track, from a  
water reservoir, walk up  
to the crag. To reach the  
other routes to the right,  
find small tracks in the  
wood.

# 18. Rocca degli Uccelli

North-East  
20 m. Multi pitch up to 120 m.

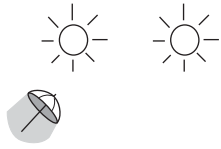

1. Sperone Est	5c,4b,5b,3b	11. Coitus Interruptus	5/A0, 4b
2. Vaccari	4b,5b,6a,5c	12. Spigolo N.O.	6a,5c,4c,5b,4b
3. Senza Fantasia	6a,6a,6b+	13. La Citta' dei sogni	7a+
4. Placca Marco Rebba	6c+	14. Killer	7b+
5. Miranda	5c,6b,6b,4b	15. Progetto	?
6. Dinda	?	16. Equilibri impossibili	8a+
7. Geppe	6c+	17. L'urtiglio	5c/a0
8. Mauro	7a	18. La ballata dei sospiri	6a,7c
9. Sandro	6c+	19. Aspettando Dimi	8a
10. Luca	7b	20. Cresta degli Uccelli	5b

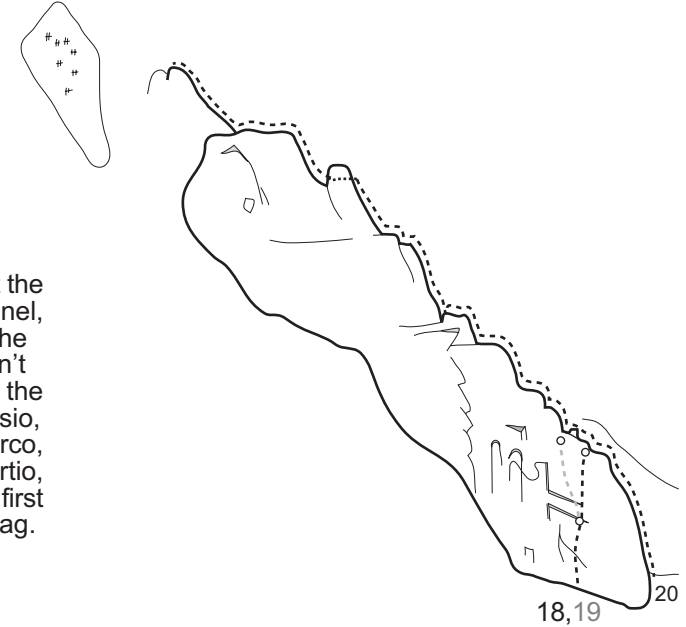
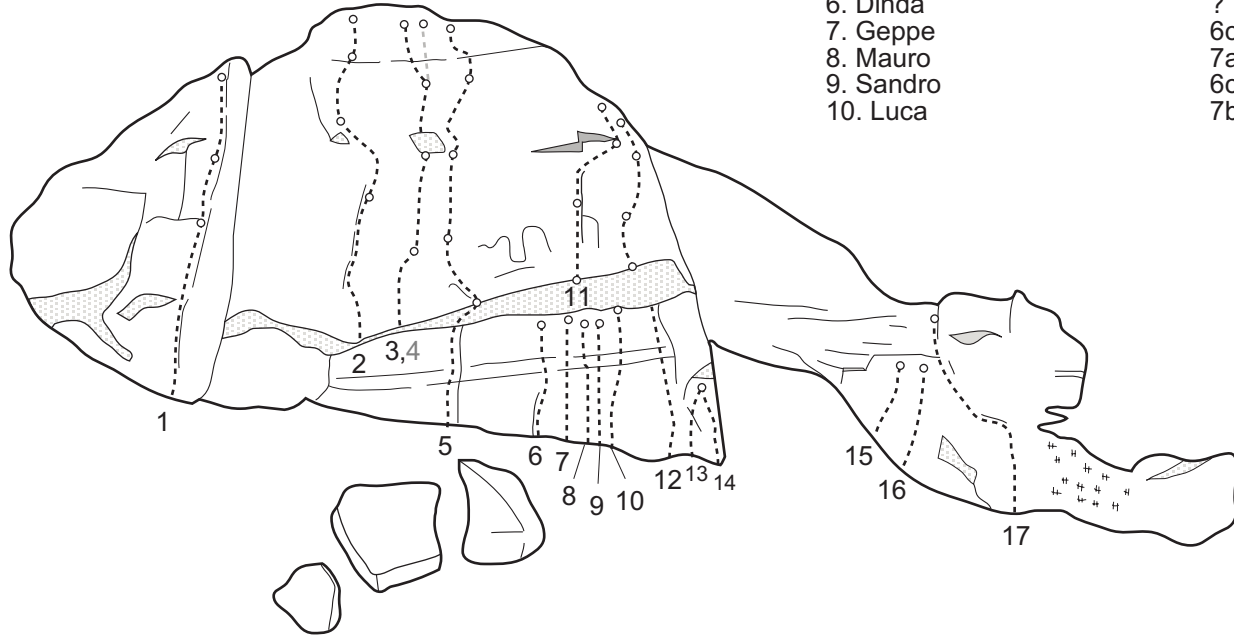

### How to find the crag:

Drive from Finale Ligure in the direction of Genova. At the outskirts of the next village, Finalpia, just before a tunnel, turn left in the direction of Camping San Martino. In the T-junction shortly after, drive straight forward and don't follow the signpost for the camping. Turn right before the river bed and follow this road in the direction of Calvisio, Boragni and Portio. Continue and pass the road for Orco, and shortly after turn right in the direction of Vezzi Portio, S.Giorgio, Spotorno and Rocche Gianche. Park in the first hairpin bend by the quarry and scramble up to the crag. For route 18 o 20, park on the road near the crag.

© coronn.com

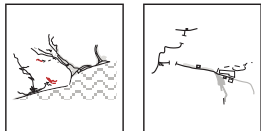

## 19 and 20. La Crema, Roadmap

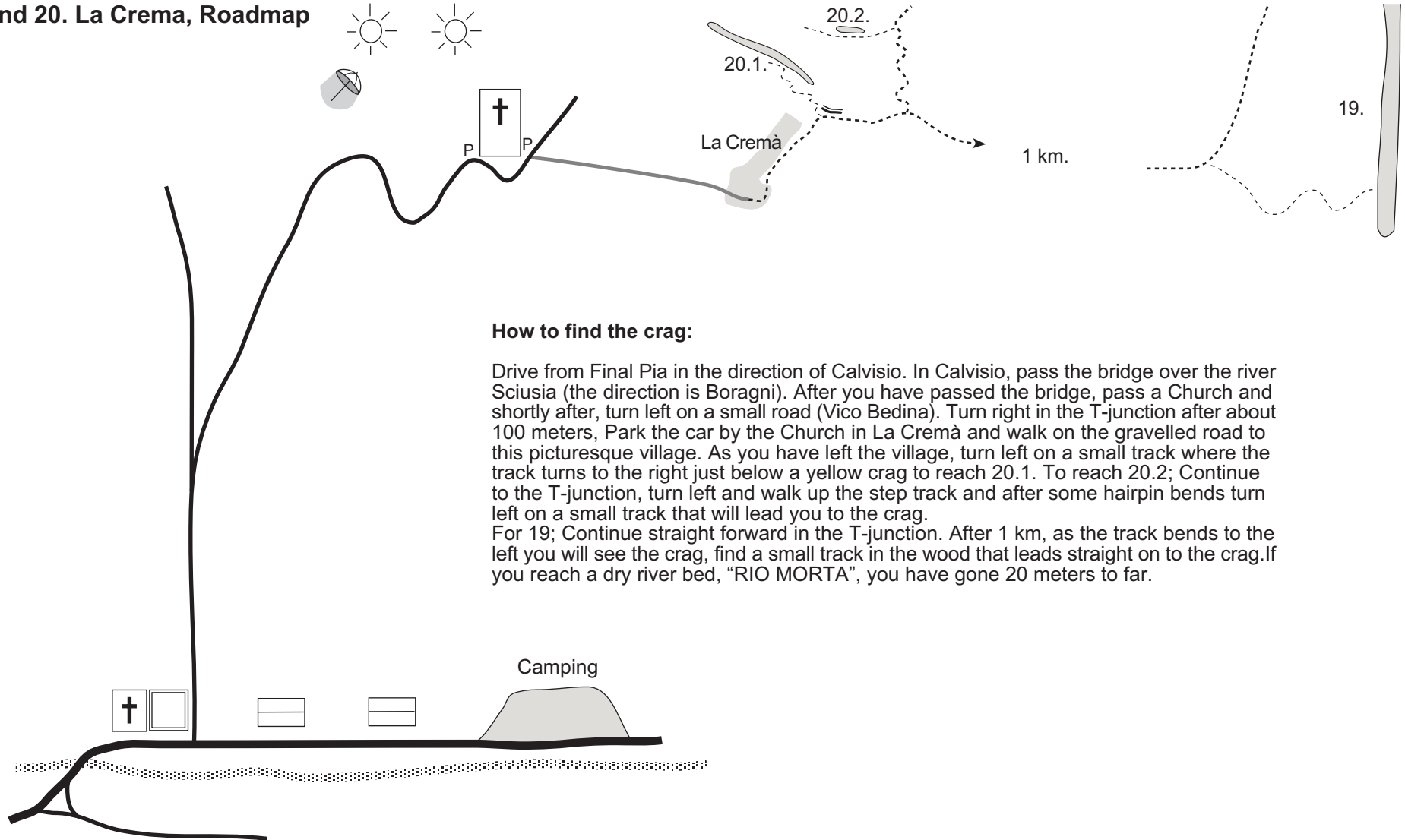

### How to find the crag:

Drive from Final Pia in the direction of Calvisio. In Calvisio, pass the bridge over the river Sciusia (the direction is Boragni). After you have passed the bridge, pass a Church and shortly after, turn left on a small road (Vico Bedina). Turn right in the T-junction after about 100 meters, Park the car by the Church in La Crema and walk on the gravelled road to this picturesque village. As you have left the village, turn left on a small track where the track turns to the right just below a yellow crag to reach 20.1. To reach 20.2; Continue to the T-junction, turn left and walk up the step track and after some hairpin bends turn left on a small track that will lead you to the crag.

For 19; Continue straight forward in the T-junction. After 1 km, as the track bends to the left you will see the crag, find a small track in the wood that leads straight on to the crag. If you reach a dry river bed, "RIO MORTA", you have gone 20 meters to far.



# 19.1. La Crema, Casa dell Vacché

South-West  
20 m.

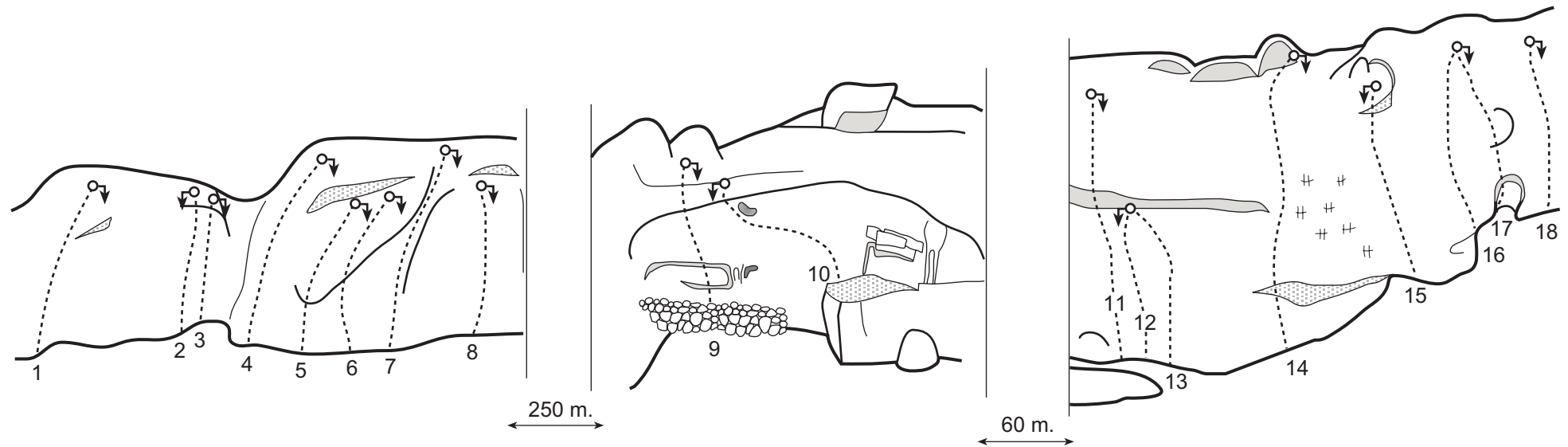
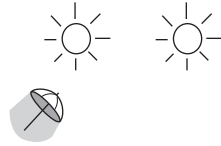

- 1. El stinkadero
- 2. D'Erschte
- 3. Odongay
- 4. Rossese per superciuk
- 5. Colpo grosso
- 6. Love story d'Autunno
- 7. Kambotscha
- 8. Squonk

- 6b+
- 6a
- 6b+
- 5c
- 6c
- 7a
- 7a
- 6a+

- 9. Biberon
- 10. Mago Merlino

- 7a+
- 7a

- 11. Bon ton
- 12. Manila
- 13. Fiore Selvaggio
- 14. Trasgressione
- 15. Mi sembra un gioco
- 16. Utopia al Tramonto
- 17. Citofonare Lilly
- 18. Pierino la peste

- 6b
- 6a
- 6b+
- 6c
- 5a
- 6c
- 6a
- 5a

© coronn.com

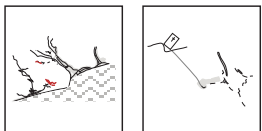

## 19.2. La Crema, Casa dell Vacché

N 44° 11.864'  
EO 08° 21.178'

South-West  
20 m.

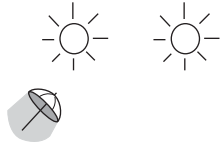

19. Incubi notturni	5c	25. Bravo Bunny	6a+,6b
20. Il coraggio di parlare	5a	26. Futura	7a
21. Il parassita di coronata	6a+	27. Strip Tease	6b
22. Fai finta almeno di capire	6a	28. La Cosa	6c
23. Sorci Verdi	6b	29. Andamento lento	7a
24. Nonno grado	6c	30. Peter Pan	6b+

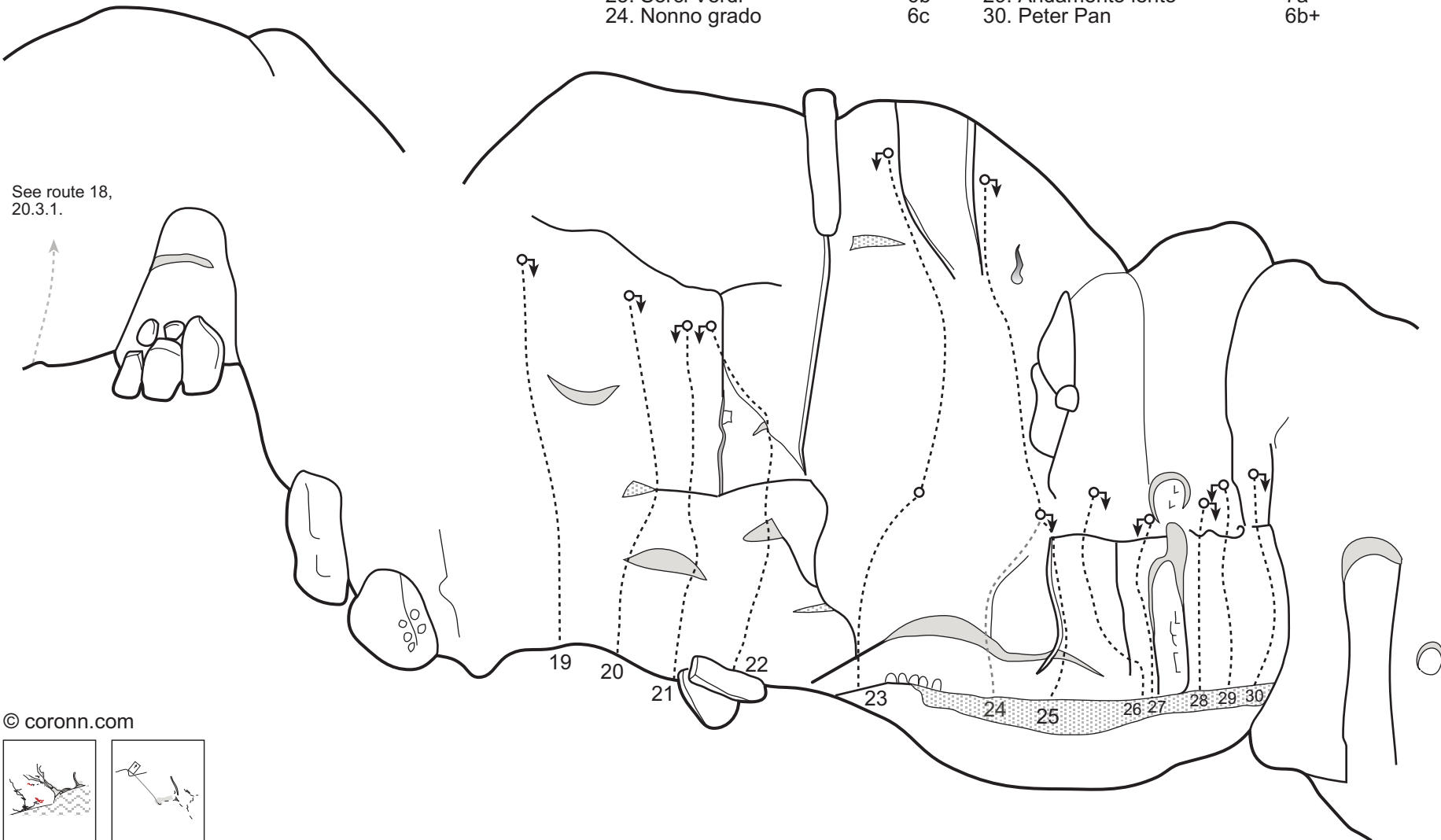

© coronn.com

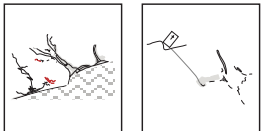

## 20.1. La Crema, Settore Basso

N 44° 11.473'  
EO 08° 21.052'

North-East  
20 m.

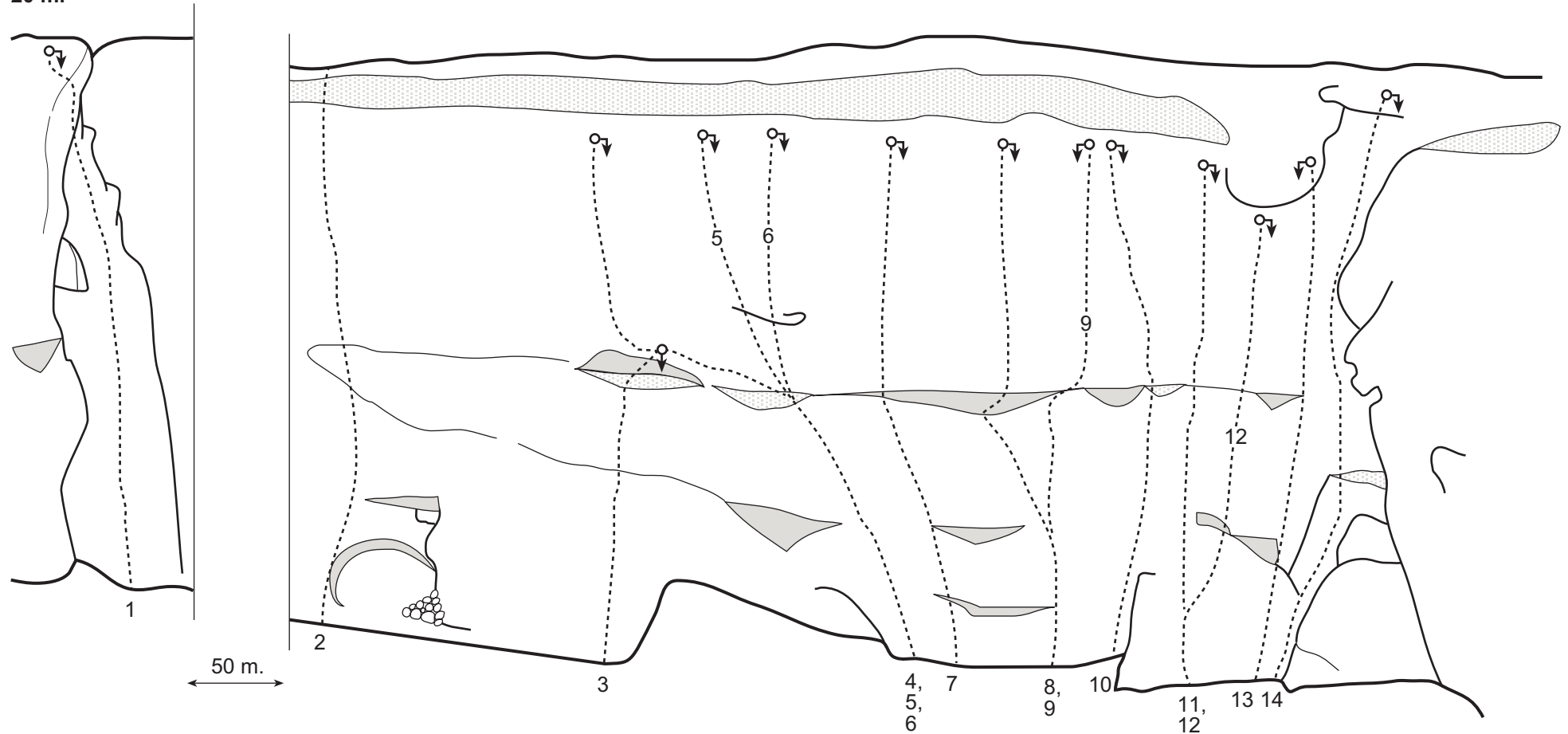
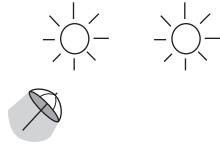

© coronn.com

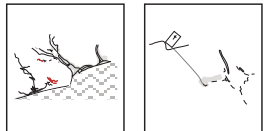

- |   |     |                        |     |                      |     |
|---|-----|------------------------|-----|----------------------|-----|
| 1. Spazzolampi                          | 7c+ | 6. Il Topo L'Elefante  | 7c+ | 11. Fatix            | 7a+ |
| 2. Oltre ogni...(not possible to climb) | 7a+ | 7. Pathos              | 7a  | 12. Idrofobia        | 6c  |
| 3. Alzati e cammina                     | 7b  | 8. Vecchia Pantera     | 6c+ | 13. Tombeur de Femme | 7a  |
| 4. Abacuc                               | 5c  | 9. Qualcono ti osserva | 7a  | 14. Fumo di Londra   | 6b  |
| 5. Quatro spit di velluto grigio        | 6a  | 10. Le declic          | 7b  |                      |     |

## 20.2. La Crema, Settore Alto

North-East  
10 m.

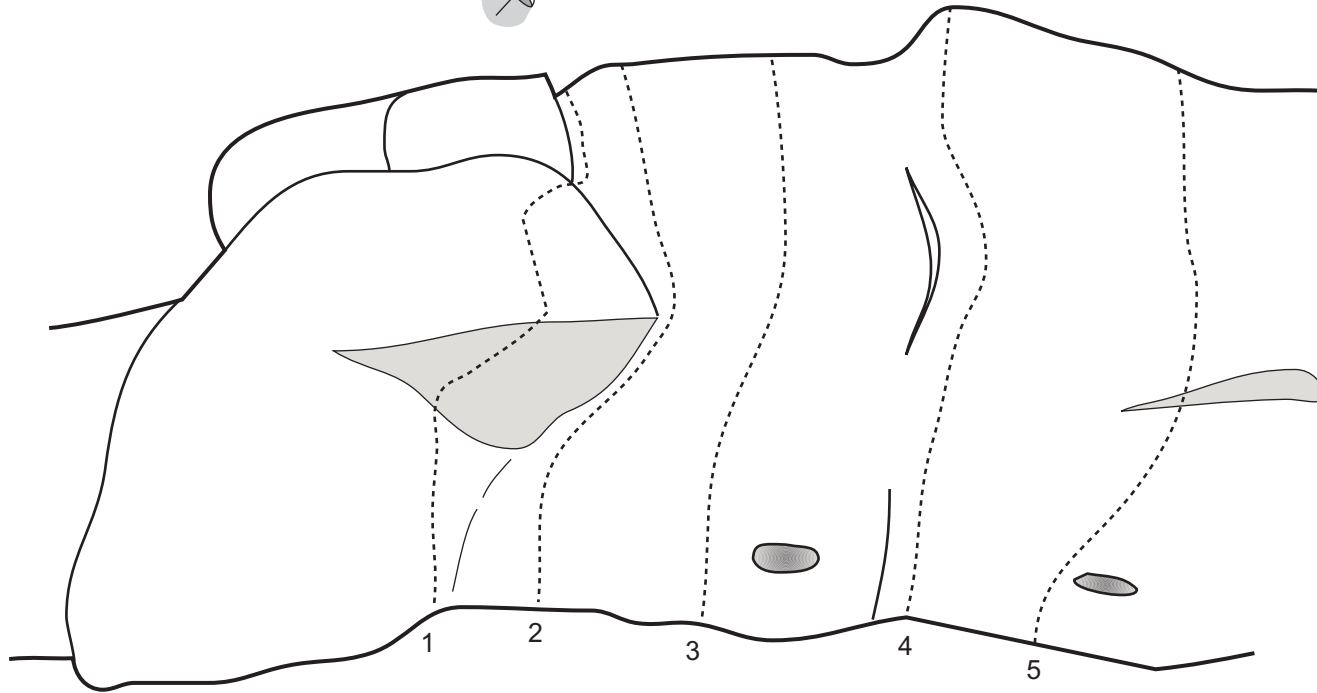
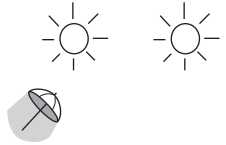

- |                         |     |
|-------------------------|-----|
| 1. La boule indienne    | 6c+ |
| 2. Wilma                | 6b  |
| 3. Pettinati (no bolts) | 5+  |
| 4. Totano 2             | 6a+ |
| 5. Si salvi chi Puo'    | 6b+ |

© coronn.com

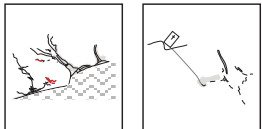

## 21.1. Rocca di Corno, Settore Est

N 44° 11.785'  
EO 08° 21.791'

East  
20 m.

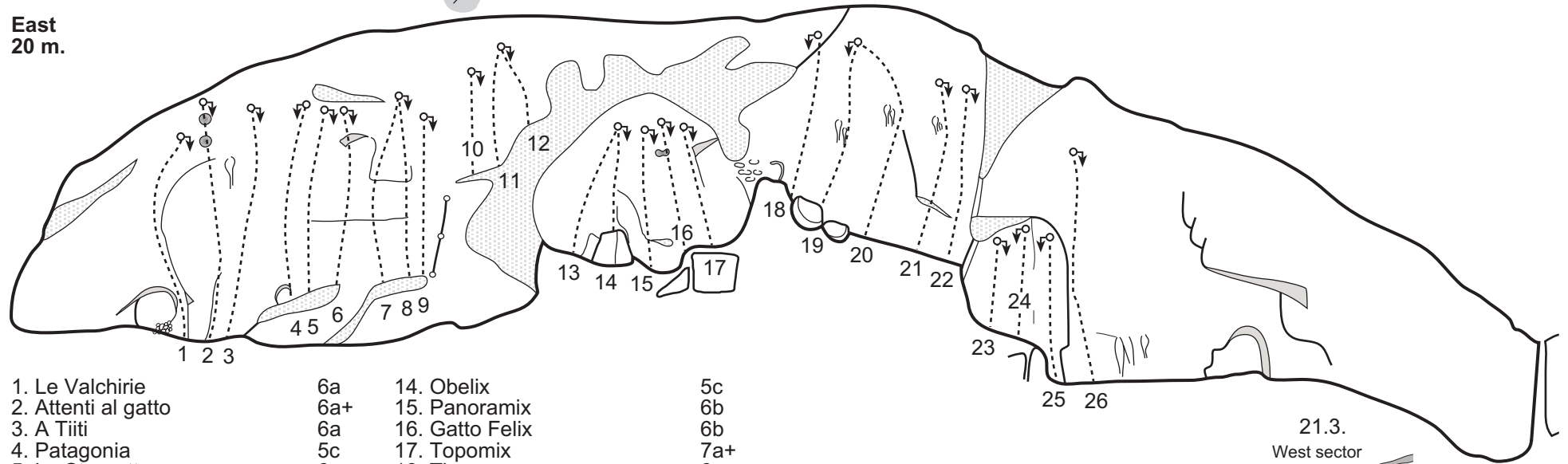
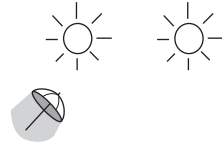

- |                     |     |                   |     |
|---------------------|-----|-------------------|-----|
| 1. Le Valchirie     | 6a  | 14. Obelix        | 5c  |
| 2. Attenti al gatto | 6a+ | 15. Panoramix     | 6b  |
| 3. A Tiiti          | 6a  | 16. Gatto Felix   | 6b  |
| 4. Patagonia        | 5c  | 17. Topomix       | 7a+ |
| 5. Lo Stregatto     | 6a  | 18. Thor          | 6c+ |
| 6. Mozary           | 6a  | 19. Canna Tonante | 6b+ |
| 7. Oasis            | 6b  | 20. Golia         | 7a  |
| 8. Ruscoroid        | 6b  | 21. Rosso antico  | 6a+ |
| 9. Proctolin        | 5c  | 22. Scorpion      | 6a  |
| 10. Control         | 5c  | 23. Mitos         | 4c  |
| 11. Falqui          | 5c  | 24. Elisir        | 6a  |
| 12. Ziguli'         | 6a  | 25. Igor          | 6b  |
| 13. Asterix         | 6a+ | 26. Dreams        | 4c  |

© coronn.com

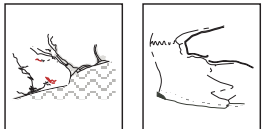

### How to find the crag:

Drive from Final Pia in the direction of Calvisio. Pass Calvisio and after approximately 1 km turn right in the direction of Vezzi. After 1 km, turn left just in a hairpin bend on to a gravelled road signed "VIA IULIA AUGUSTA", "VIA ROMANA". Park at a lay bay by the foot of the crag or (\*better) continue and pass a bridge, park and take the track to this superb crag. \* This track feels easy to walk, the other one has a step and hard access during the last 300 meters.

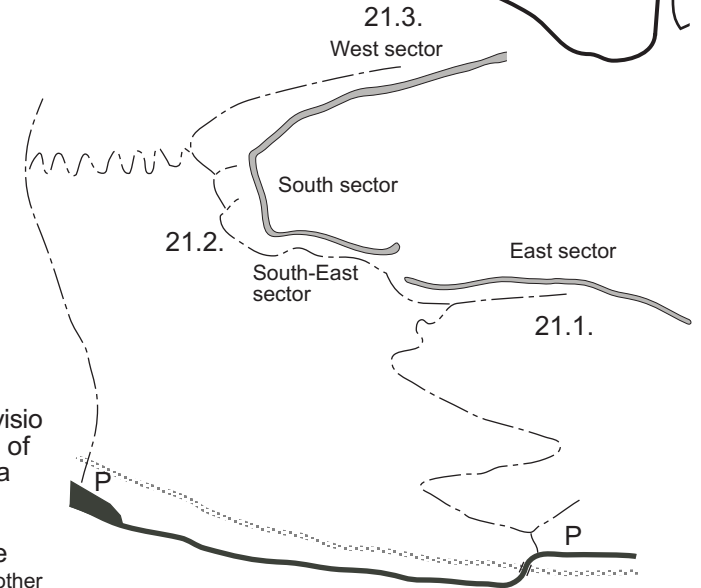



## 21.2. Rocca di Corno, Settore Sud é Sud-Est

N 44° 11.732'  
EO 08° 21.765'

South and South-East  
30 m.  
Multi pitch 70 m.

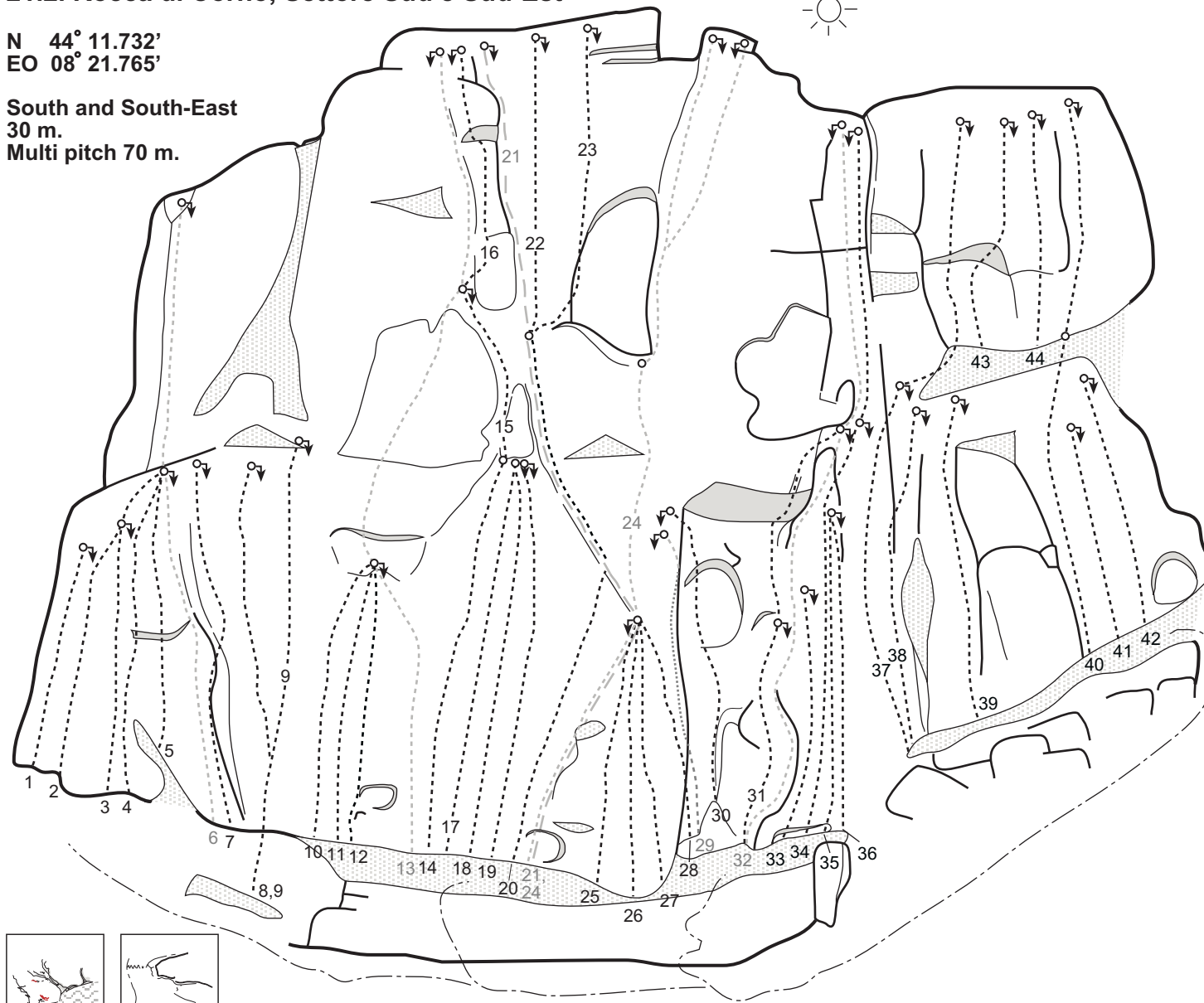

- |                                |          |
|--------------------------------|----------|
| 1. Schwanzus longus            | 6a       |
| 2. Sbrinsa ciuvende            | 6a       |
| 3. Ritmi Solare                | 5c       |
| 4. Daniel Street               | 6b+      |
| 5. Spitgrip                    | 6b       |
| 6. Foletto Rosso               | 6b,5a    |
| 7. Pichenibulina               | 6b+      |
| 8. Ten                         | 6a+,5c   |
| 9. Costringimi forte           | 6b       |
| 10. Alchimie d'Estate          | 6c+      |
| 11. Due dita di violenza       | 6b+      |
| 12. Proiettile Umano           | 6b       |
| 13. Il Topo                    | 6a,5,6c  |
| 14. Bei tempi                  | 6b+      |
| 15. Utopia                     | 6c       |
| 16. Silvester                  | 7b       |
| 17. Odeon                      | 6b       |
| 18. Pescegatto                 | 7a       |
| 19. Destin anime'              | 7b       |
| 20. Fora et labora             | 6c       |
| 21. Ipsilon                    | 4c,5c,5b |
| 22. Dall' Inferno non si torna | 7b       |
| 23. ?                          | ?        |
| 24. Titomanlio                 | 4c,4c,5b |
| 25. I sospiri di gastone       | 5c       |
| 26. Jagermaister               | 6a+      |
| 27. E se... si prova di qua    | 6a       |
| 28. Variante Ascari            | 6a       |
| 29. ?                          | 5b       |
| 30. ?                          | 5b       |
| 31. Il portale                 | 5c,6c    |
| 32. Spencer Tracy              | 6a+,6b   |
| 33. Blu profondo               | 6c+      |
| 34. Il Pescecane               | 6c,5c    |
| 35. La Signora in Rosso        | 6c+      |
| 36. Osso duro                  | 6c       |
| 37. Prima fessura              | 5b,5b    |
| 38. Micro sistema              | 6a       |
| 39. Seconda fessura            | 4c       |
| 40. Terza fessura              | 4c,4c    |
| 41. Angela                     | 5c       |
| 42. Carla                      | 5c       |
| 43. Le Fate                    | 6b       |
| 44. Ibis                       | 6b       |

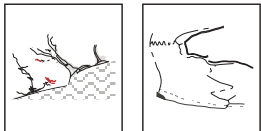

### 21.3. Rocca di Corno, Settore Ovest

West  
40 m.  
Multi pitch 60 m.

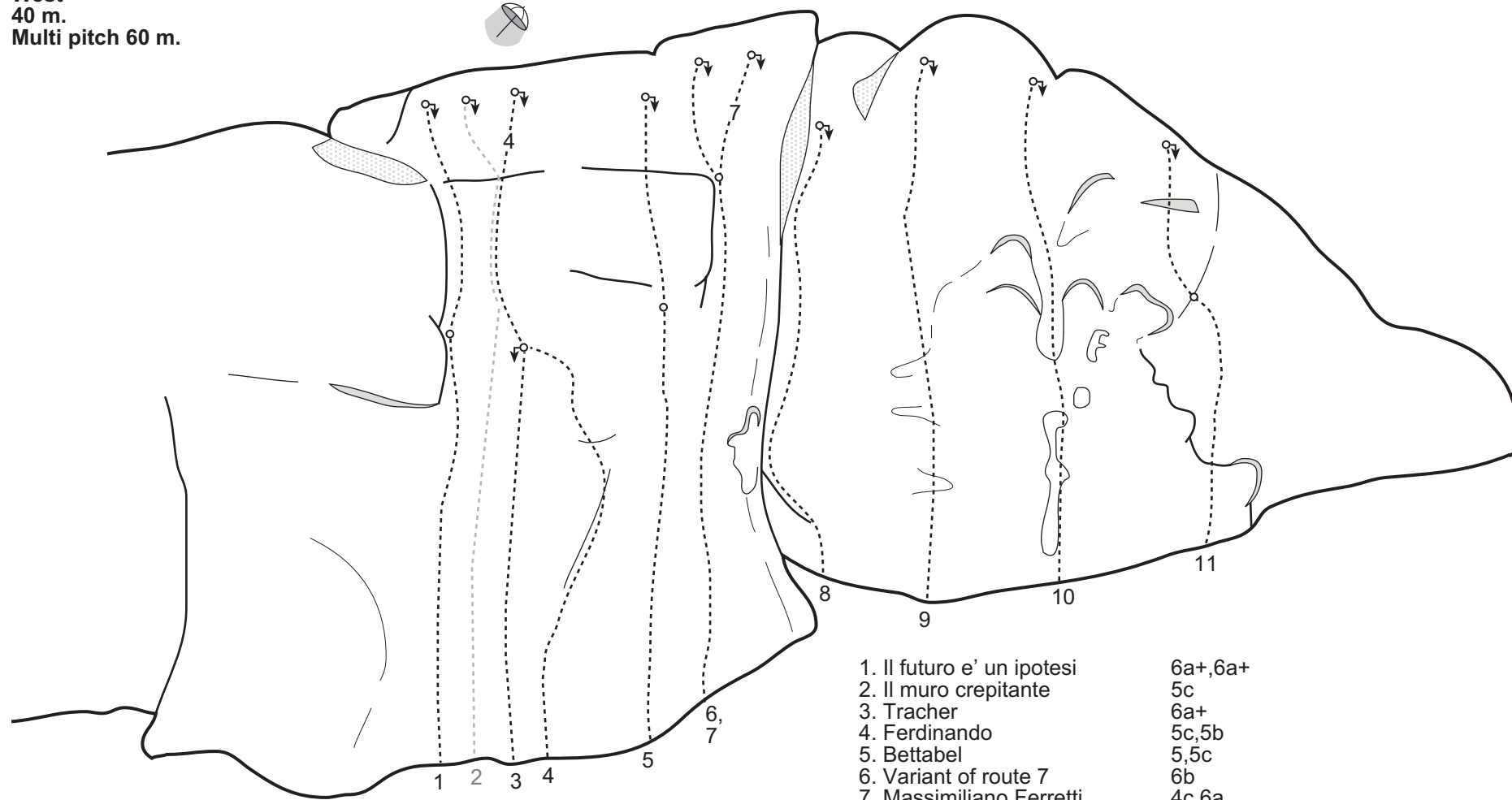
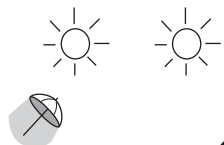

- |                            |         |
|----------------------------|---------|
| 1. Il futuro e' un ipotesi | 6a+,6a+ |
| 2. Il muro crepitante      | 5c      |
| 3. Tracher                 | 6a+     |
| 4. Ferdinando              | 5c,5b   |
| 5. Bettabel                | 5,5c    |
| 6. Variant of route 7      | 6b      |
| 7. Massimiliano Ferretti   | 4c,6a   |
| 8. Enfant terrible         | 6a      |
| 9. Hambre                  | 7c      |
| 10. Rombo di vento         | 6c      |
| 11. Rock stupid            | 6c,7a+  |

© coronn.com

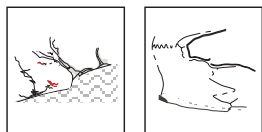

## 22.1. Le Manie, Museo dell' Uomo

N 44° 11.877'  
EO 08° 22.371'

South  
15 m.

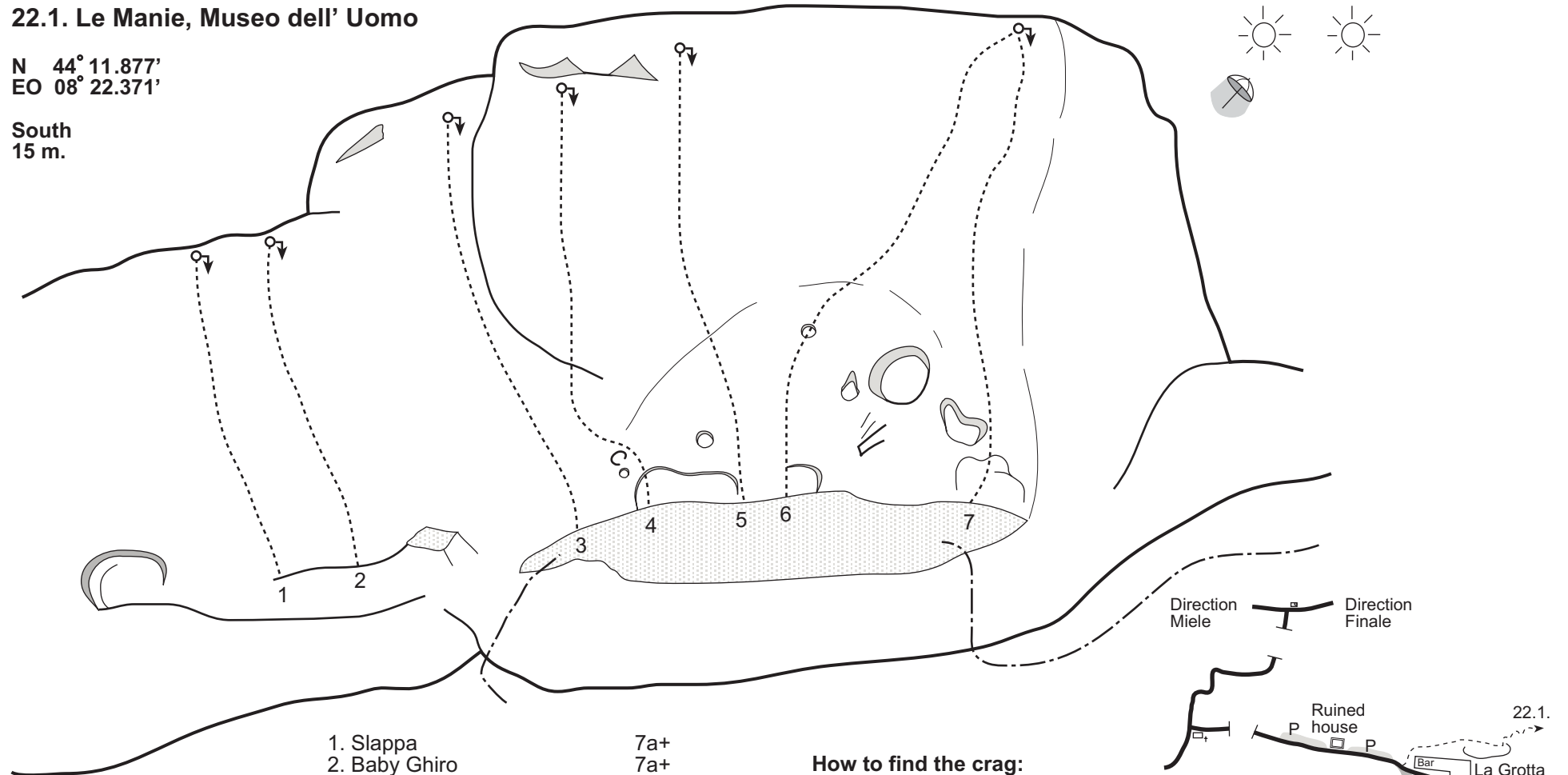

- |                             |     |
|-----------------------------|-----|
| 1. Slappa                   | 7a+ |
| 2. Baby Ghio                | 7a+ |
| 3. Incontri con gli animali | 6b+ |
| 4. Urka (Catmaker)          | 8b+ |
| 5. L'Incontentabile         | 7c+ |
| 6. Museo dell' Uomo         | 7b+ |
| 7. Orrilo                   | 7b  |

### How to find the crag:

Drive from Finale Ligure in the direction of Genova. At the outskirts of the next village, Finalpia, just before a tunnel, turn left in the direction of Camping San Martino. Turn left before the village Manie after a house that looks like a church, follow the road in the direction of "Osteria del BOSCO" and "La Grotta". After about 1 km, turn left just before the church, follow signpost for "La Grotta". Park before the small village on a laybay. Follow the road, turn left just before the Bar. Walk down to "La Grotta". At the end of this cave, pass the door and follow a small track parallel to the crag for 250 meters. Approach 5 minutes.

© coronn.com

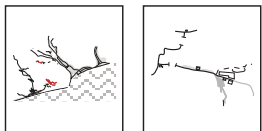

## 22.2. Le Manie, Mesa Verde

N 44° 12.145'  
EO 08° 22.489'

North-East  
15 m.

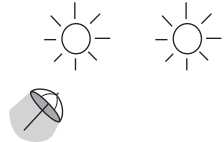

Direction Miele Direction Finale

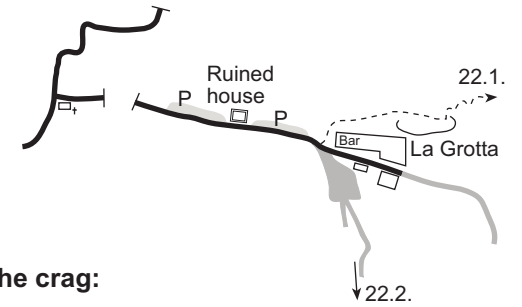

### How to find the crag:

Drive from Finale Ligure in the direction of Genova. At the outskirts of the next village, Finalpia, just before a tunnel, turn left in the direction of Camping San Martino. Turn left before the village Manie after a house that looks like a church, follow the road in the direction of "Osteria del BOSCO" and "La Grotta". After about 1 km, turn left just before the church, follow signpost for "La Grotta". Park before the small village on a lay-by. Follow the road, turn right by the Bar, cross the village parking spot and descend the gravelled road. After 500 to 600 meters you will see the crag on the left side of the road. Approach 15 minutes.

- |                  |    |
|------------------|----|
| 1. Mesa Verde    | 7b |
| 2. Il Pirata     | 8a |
| 3. Gila          | 7b |
| 4. U ma da prima | 7c |

© coronn.com

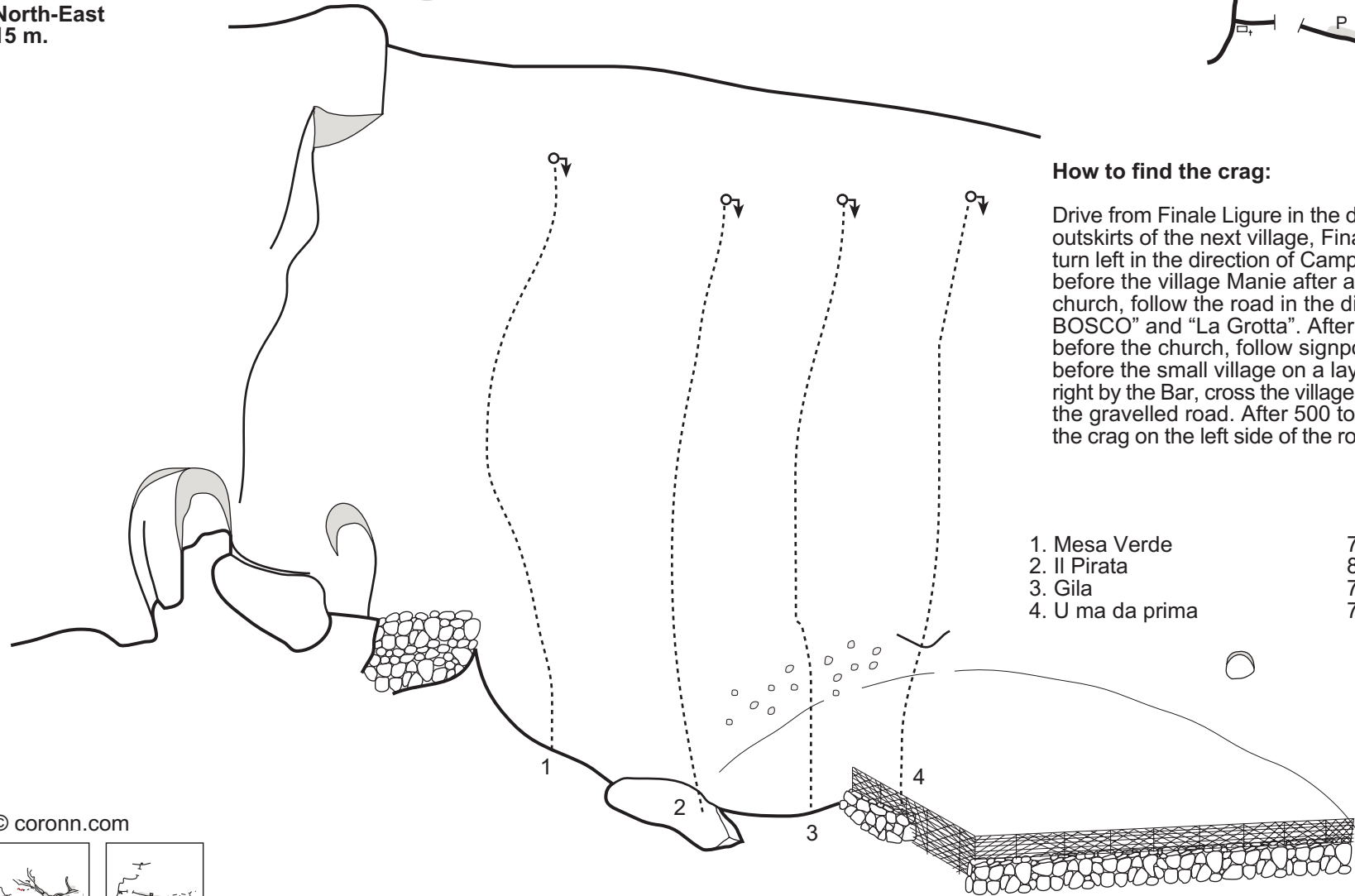
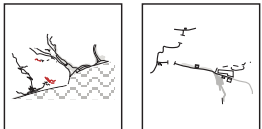

## 23. Capo Noli



N 44° 11.794'  
EO 08° 25.539' (Nolitudine)

South, South-West  
40 m.

On the coast road from Finale Ligure to Savona, between the village Varigooti and Noli, you can find three areas that is see facing;

### Dancing Dalle

Mister Fish	5c
2. capitan Findus	6a
3. Sabry	6a+
4. Aquafan	7a+
5. Sospesa	?
6. Dancing fool	7b
7. Aquaplaning	7c
8. Only locals	5c
9. Ruggiu de ma	5c
10. Dancing Dalle	7a

### I Pilastri

1. ?	?
2. Vedo Nudo	7a+
3. Swimming cool	6b
4. topless	5b
5. Calma piatta	5b
6. Lo Sibro	5a

© coronn.com

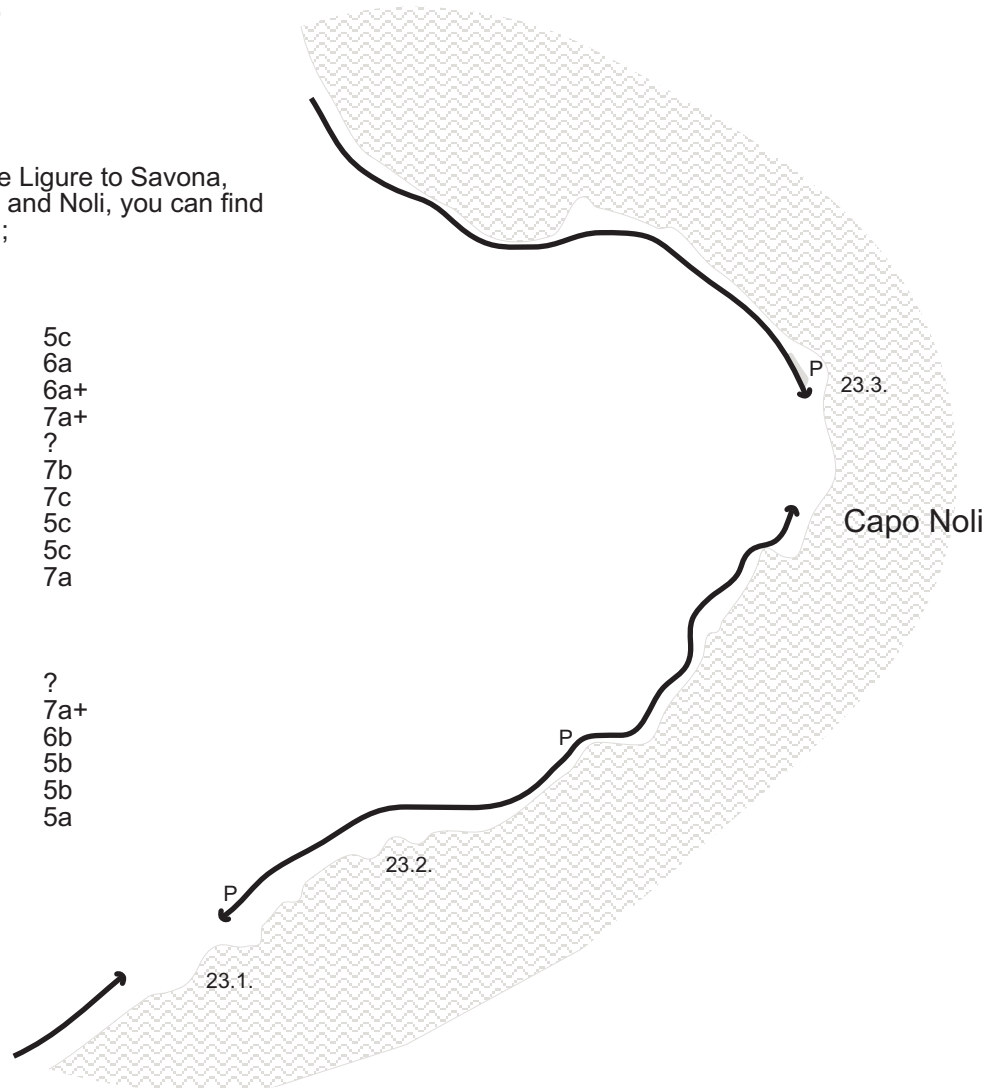
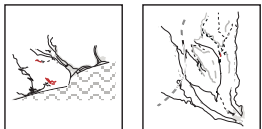

7. Frescone d'oltralpe	5c
8. Seadas	5c
9. Pensa	6a
10. Rockstorto	5a

A long (350 m.) travers;  
11. In scio bolesomme 5c

### Nolitudine

1. Uscita di Sicurezza	5b
2. Dipende	6b+
3. Raschia scogli	5b
4. Hola	6a
5. Guapa	4b,5b
6. Strie	4c
7. Luassu	5b
8. Madunetta	4b,5b,4b
9. Purpurangu	6a,6a,6a
10. Buga Sbursa	6b+
11. Classica	4b,5b,5c
12. Spigola	4b

A even longer travers;  
13. Y2K (1500 m.) Swim if you fall Max 7b